

To our customers,

Old Company Name in Catalogs and Other Documents

On April 1st, 2010, NEC Electronics Corporation merged with Renesas Technology Corporation, and Renesas Electronics Corporation took over all the business of both companies. Therefore, although the old company name remains in this document, it is a valid Renesas Electronics document. We appreciate your understanding.

Renesas Electronics website: <http://www.renesas.com>

April 1st, 2010
Renesas Electronics Corporation

Issued by: Renesas Electronics Corporation (<http://www.renesas.com>)

Send any inquiries to <http://www.renesas.com/inquiry>.

Notice

1. All information included in this document is current as of the date this document is issued. Such information, however, is subject to change without any prior notice. Before purchasing or using any Renesas Electronics products listed herein, please confirm the latest product information with a Renesas Electronics sales office. Also, please pay regular and careful attention to additional and different information to be disclosed by Renesas Electronics such as that disclosed through our website.
2. Renesas Electronics does not assume any liability for infringement of patents, copyrights, or other intellectual property rights of third parties by or arising from the use of Renesas Electronics products or technical information described in this document. No license, express, implied or otherwise, is granted hereby under any patents, copyrights or other intellectual property rights of Renesas Electronics or others.
3. You should not alter, modify, copy, or otherwise misappropriate any Renesas Electronics product, whether in whole or in part.
4. Descriptions of circuits, software and other related information in this document are provided only to illustrate the operation of semiconductor products and application examples. You are fully responsible for the incorporation of these circuits, software, and information in the design of your equipment. Renesas Electronics assumes no responsibility for any losses incurred by you or third parties arising from the use of these circuits, software, or information.
5. When exporting the products or technology described in this document, you should comply with the applicable export control laws and regulations and follow the procedures required by such laws and regulations. You should not use Renesas Electronics products or the technology described in this document for any purpose relating to military applications or use by the military, including but not limited to the development of weapons of mass destruction. Renesas Electronics products and technology may not be used for or incorporated into any products or systems whose manufacture, use, or sale is prohibited under any applicable domestic or foreign laws or regulations.
6. Renesas Electronics has used reasonable care in preparing the information included in this document, but Renesas Electronics does not warrant that such information is error free. Renesas Electronics assumes no liability whatsoever for any damages incurred by you resulting from errors in or omissions from the information included herein.
7. Renesas Electronics products are classified according to the following three quality grades: “Standard”, “High Quality”, and “Specific”. The recommended applications for each Renesas Electronics product depends on the product’s quality grade, as indicated below. You must check the quality grade of each Renesas Electronics product before using it in a particular application. You may not use any Renesas Electronics product for any application categorized as “Specific” without the prior written consent of Renesas Electronics. Further, you may not use any Renesas Electronics product for any application for which it is not intended without the prior written consent of Renesas Electronics. Renesas Electronics shall not be in any way liable for any damages or losses incurred by you or third parties arising from the use of any Renesas Electronics product for an application categorized as “Specific” or for which the product is not intended where you have failed to obtain the prior written consent of Renesas Electronics. The quality grade of each Renesas Electronics product is “Standard” unless otherwise expressly specified in a Renesas Electronics data sheets or data books, etc.
 - “Standard”: Computers; office equipment; communications equipment; test and measurement equipment; audio and visual equipment; home electronic appliances; machine tools; personal electronic equipment; and industrial robots.
 - “High Quality”: Transportation equipment (automobiles, trains, ships, etc.); traffic control systems; anti-disaster systems; anti-crime systems; safety equipment; and medical equipment not specifically designed for life support.
 - “Specific”: Aircraft; aerospace equipment; submersible repeaters; nuclear reactor control systems; medical equipment or systems for life support (e.g. artificial life support devices or systems), surgical implantations, or healthcare intervention (e.g. excision, etc.), and any other applications or purposes that pose a direct threat to human life.
8. You should use the Renesas Electronics products described in this document within the range specified by Renesas Electronics, especially with respect to the maximum rating, operating supply voltage range, movement power voltage range, heat radiation characteristics, installation and other product characteristics. Renesas Electronics shall have no liability for malfunctions or damages arising out of the use of Renesas Electronics products beyond such specified ranges.
9. Although Renesas Electronics endeavors to improve the quality and reliability of its products, semiconductor products have specific characteristics such as the occurrence of failure at a certain rate and malfunctions under certain use conditions. Further, Renesas Electronics products are not subject to radiation resistance design. Please be sure to implement safety measures to guard them against the possibility of physical injury, and injury or damage caused by fire in the event of the failure of a Renesas Electronics product, such as safety design for hardware and software including but not limited to redundancy, fire control and malfunction prevention, appropriate treatment for aging degradation or any other appropriate measures. Because the evaluation of microcomputer software alone is very difficult, please evaluate the safety of the final products or system manufactured by you.
10. Please contact a Renesas Electronics sales office for details as to environmental matters such as the environmental compatibility of each Renesas Electronics product. Please use Renesas Electronics products in compliance with all applicable laws and regulations that regulate the inclusion or use of controlled substances, including without limitation, the EU RoHS Directive. Renesas Electronics assumes no liability for damages or losses occurring as a result of your noncompliance with applicable laws and regulations.
11. This document may not be reproduced or duplicated, in any form, in whole or in part, without prior written consent of Renesas Electronics.
12. Please contact a Renesas Electronics sales office if you have any questions regarding the information contained in this document or Renesas Electronics products, or if you have any other inquiries.

(Note 1) “Renesas Electronics” as used in this document means Renesas Electronics Corporation and also includes its majority-owned subsidiaries.

(Note 2) “Renesas Electronics product(s)” means any product developed or manufactured by or for Renesas Electronics.

PLC Micro-controller, M16C/6S Evaluation Kit

EV5 (US Edition) User's Manual

Renesas single chip microcomputer
M16C family /M16C/6S group

Contents







1. Precautions for Safety.....	3
2. Introduction	5
3. Special Cautions	5
4. Product Overview.....	5
4.1 Features of the product.....	5
4.2 Product structure.....	6
4.3 Product specification.....	7
4.4 Limited uses.....	8
4.5 How to get the M16C/6S data link layer library (provided free).....	8
4.6 Structure.....	8
4.7 Connectors.....	9
4.7.1 Connector for connecting to external systems (CN4)	9
4.7.2 Connector for on-chip debugging and flash writing (CN2)	11
4.7.3 RS232-C interface connector to connect to a PC (J1)	12
4.7.4 Other connectors	12
4.8 Switches.....	13
4.8.1 Description of switches on the PLC module (the upper board).....	13
4.8.2 Description of switches on the dedicated interface board (the lower board)	14
4.9 LED	16
4.10 AC Cables.....	16
5. How to use the program for simple communication tests and software development environment	17
5.1 Environment for the usage of the program for simple communication tests.	17
5.2 Start-up and execution of the program for simple communication tests.....	18
5.2.1 How to start the program for simple communication tests	18
5.2.2 Setting procedure for the receiver	22
5.2.3 Setting procedure for the sender.....	24
5.2.4 Transmission modes (Unicast and Broadcast).....	25
5.3 Sample Test Program's ID Code	26
5.4 Software Developing Environment	26

1. Precautions for Safety





Definitions of Signal Words

In both the user's manual and on the product itself, several icons are used to insure proper handling of this product and also to prevent injuries to you or other persons, or damage to your properties.

This chapter describes the precautions which should be taken in order to use this product safely and properly. Be sure to read this chapter before using this product.

	<p>This symbol represents a warning about safety. It is used to arouse caution about a potential danger that will possibly inflict an injury on persons. To avoid a possible injury or death, please be sure to observe the safety message that follows this symbol.</p>
 WARNING	<p>WARNING indicates a potentially dangerous situation that will cause death or heavy wound unless it is avoided.</p>
 CAUTION	<p>CAUTION indicates a potentially dangerous situation that will cause a slight injury or a medium-degree injury unless it is avoided.</p>
<p>In addition to the three above, the following are also used as appropriate.</p>	
<p>△ means WARNING or CAUTION.</p>	
<p>Example:</p>	 <p>CAUTION AGAINST AN ELECTRIC SHOCK</p>
<p>⊘ means PROHIBITION.</p>	
<p>Example:</p>	 <p>DISASSEMBLY PROHIBITED</p>
<p>● means A FORCIBLE ACTION.</p>	
<p>Example:</p>	 <p>UNPLUG THE POWER CABLE FROM THE RECEPTACLE</p>

⚠ WARNING

Warnings for AC Power Supply:	
	<ul style="list-style-type: none"> ● Do not touch the plug of the AC power cable when your hands are wet. This may cause electric shock. ● If other equipment is connected to the same branch circuit, care should be taken not to overload the circuit.
	<ul style="list-style-type: none"> ● If you smell a strange odor, hear an unusual sound, or see smoke coming from this product, then disconnect power immediately by unplugging both the AC/DC Adapter and the AC power cables for PLC signal from the outlet. Do not use this as it is because of the danger of electric shock and/or fire. In this case, contact your local distributor. ● Before setting up this emulator and connecting it to other devices, turn off power or remove a power cable to prevent injury or product damage.
Warnings to Be Taken for This Product:	
	<ul style="list-style-type: none"> ● Do not disassemble or modify this product. Personal injury due to electric shock may occur if this product is disassembled and modified. Disassembling and modifying the product will void your warranty. ● Make sure nothing falls into the cooling fan on the top panel, especially liquids, metal objects, or anything combustible.
Warning for Installation:	
	<ul style="list-style-type: none"> ● Do not set this product in water or areas of high humidity. Make sure that the product does not get wet. Spilling water or some other liquid into the product may cause unrepairable damage.
Warning for Use Environment:	
	<ul style="list-style-type: none"> ● This equipment is to be used in an environment with a maximum ambient temperature of 40°C. Care should be taken that this temperature is not exceeded.

2. Introduction

Thank you for purchasing our PLC micro-controller evaluation kit, EV5.

EV5 is designed to for Renesas Technology's PLC micro-controller M16C/6S and works for PLC communication within the FCC band. Also, EV5 has a built-in program*1 for simple communication test written in a flash memory, so that it is possible to evaluate performance immediately in PLC communication of M16C/6S. Besides, RS232C interface is also included, allowing easy connection to a PC. The following part explains the product overview and usage of EV5.

3. Special Cautions

1) PLC Regulations

Please confirm with PLC regulations in your use region and execute the necessary procedures before it used.

This device complies with part 15 of the FCC Rules. Operation is subject to the following two conditions:

- (1) This device may not cause harmful interference, and
- (2) This device must accept any interference received, including interference that may cause undesired operation

2) ACDC Adapter

We include other company's AC/DC power supply in this kit for the convenience.

AC/DC power supply is not our product, **SO WE CAN NOT GUARANTEE ALL THINGS INCLUDING SAFETY ISSUES, RELATED WITH THE AC/DC POWER SUPPLY.**

Please be careful for safety when it works.

And please use it for only developing and testing after confirming the safety standard regulation in utilization area.

Please do not resell to the consumer, and let it use.

Do not touch the plug of AC power cable when your hands are wet. This may cause electric shock.

4. Product Overview

4.1 Features of the product

Features of EV5 are summarized in the following Table 1.

Table 1: Features of EV5

Features	Advantages
1.Equipped with RS232C interface	Easily connectable to a PC.
2.Built-in program for simple communication tests	Allows simple communication tests without developing software.
3.Equipped with a connector for on-chip debugger	Connectable to Renesas' debugger or flash writer
4.Equipped with connectors which are accessible to all free I/O ports of M16C/6S micro-controller	Enables to develop various applications
5.Equipped with a selector for power switching	Allows power supply both from AC/DC adapter (DC5V) and customer's application systems.

*1: The simple communication test program is same with the sample program included in D2DL (DLL library).

4.2 Product structure

The following Table 2 and Figure1 show contents of EV5.

Table 2: Contents of EV5

Product Name	Description	Qt.
1.The evaluation kit body	Consists of a PLC module and a dedicated interface board	1
2.AC/DC adapter	DC5V 2A	1
3.Cable to connect to a PC	Serial crossing cable	1
4.E8a/E8 14PIN-10PIN Convert Baord	14-10 convert board for E8a/E8 (R0KZC000000002R)	1
5.AC cable for 125VAC	For outputting PLC signals (Withstand voltage 125V)	1



1. The evaluation kit body



2. AC/DC adapter



3. Cable to connect to a PC



4. 14-10 convert board for E8a/E8

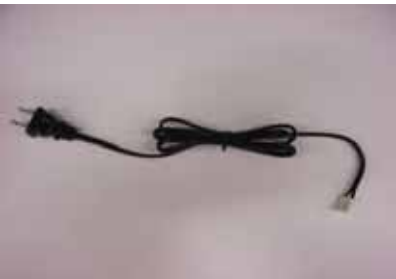

5. AC cable for 125VAC

Figure 1: Contents of EV5

4.3 Product specification

The specification of EV5 is described in the following [Table 3](#)

Table 3: Specification of EV5

Items	Description						
Communication	Select among the following three modes*2						
Speed	<table border="0"> <tr> <td>Standard Mode (SM)</td> <td>7.5Kbps</td> </tr> <tr> <td>Robust Mode (RM)</td> <td>5.0Kbps</td> </tr> <tr> <td>Extremely Robust Mode (ERM)</td> <td>1.25Kbps</td> </tr> </table>	Standard Mode (SM)	7.5Kbps	Robust Mode (RM)	5.0Kbps	Extremely Robust Mode (ERM)	1.25Kbps
Standard Mode (SM)	7.5Kbps						
Robust Mode (RM)	5.0Kbps						
Extremely Robust Mode (ERM)	1.25Kbps						
Voltage for PLC communication	AC under 125V						
Operating supply voltage	DC 5V						
Size	70mm(W)*47mm(L)*47mm(H)						
Connectors for external connection	4 connectors 1. Connector for PLC signals (2 pins) 2. Connector for connecting to external systems (26 pins) 3. Connector for connecting to a PC - SUB connector (9 pins) 4. Connector for on-chip debugging and flash memory writing (10pins)						
Switches	3 switches: 1. Reset switch (SW1 on the upper board) 2. Reset switch (SW1 on the lower board) 3. Switch for switching CNVss modes (SW2 on the upper board)						
Operating Ambient Temperature	15 to 40 degrees						
Power consumption	In transmission: approx. 700mW (Transmission load 51Ω) In reception: approx.450mW						
Included Sample Program	Program for simple communication tests (This program and the sample program included in DLL library D2DL are the same.)						

*2: When it uses “adaptive rate control” function, the transmission speed is automatically switched to SM→RM→ERM depending on the status of the transmission channel.

4.4 Limited uses

Since EV5 is developed to evaluate LSI without considering operating ambient temperature and humidity, please avoid embedding this product to your devices to sell.

4.5 How to get the M16C/6S data link layer library (provided free)

In order to develop an application program by using this board, you will need our data link layer library provided free. Various sample programs and documents which may be useful in developing application programs have also been prepared. If you would like some of them, please contact our contact center (csc@renesas.com), using the following subject.

Subject: Request M16C/6S data link layer library

We will send a "user registration form" by return.

4.6 Structure

EV5 consists of two boards. The upper board is a PLC modem module which is comprised of a PLC microcomputer and its peripheral circuit. The lower board is a dedicated interface board which has four connectors, the connector for on-chip debugging and flash memory writing (CN2), the RS232-C connector to connect to the PC (J1), the connector for connecting to external systems (CN4), and the connector for connecting to the upper board (CN3). The connector CN4 and the connector U-CN1 on the upper board have the same pin configuration and number of pins. Therefore it is also possible to connect the PLC module directly to your system without using the interface board (the lower board).

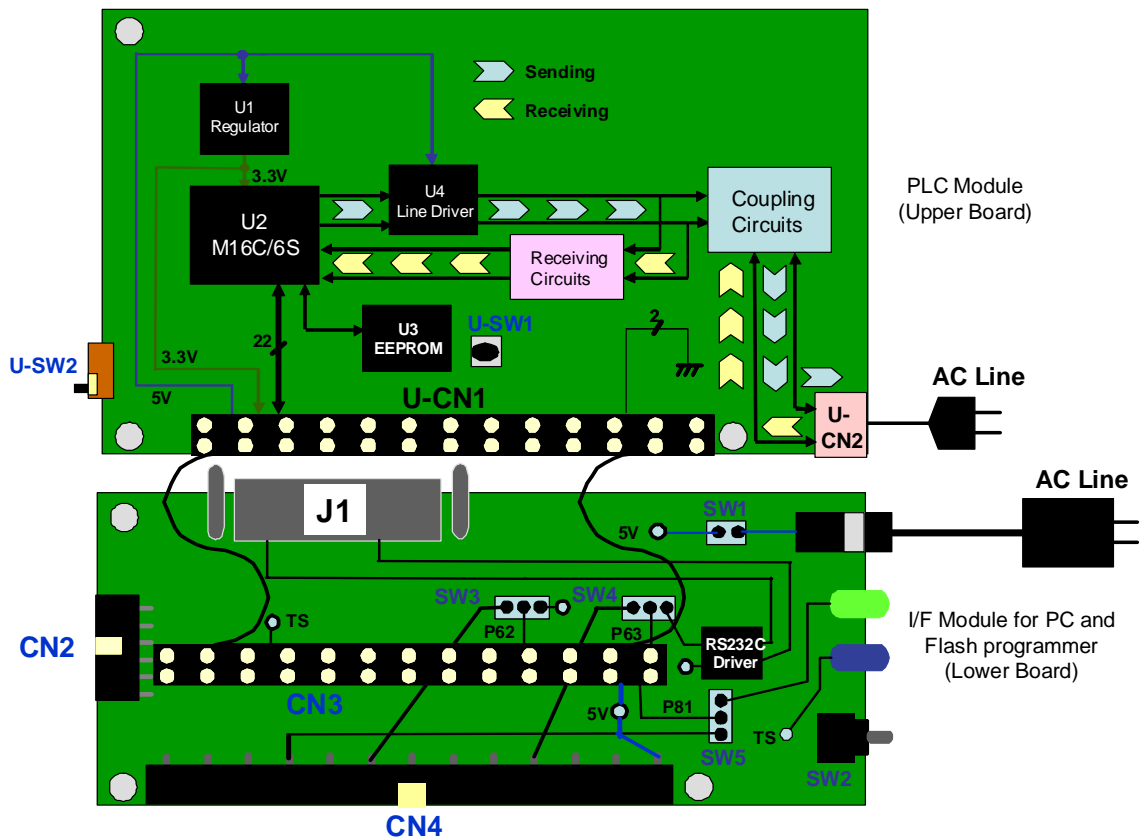

Figure 2: EV5 circuit block diagram

4.7 Connectors

This part explains details about the connectors on the I/F module (the lower board) which are connected to external systems.

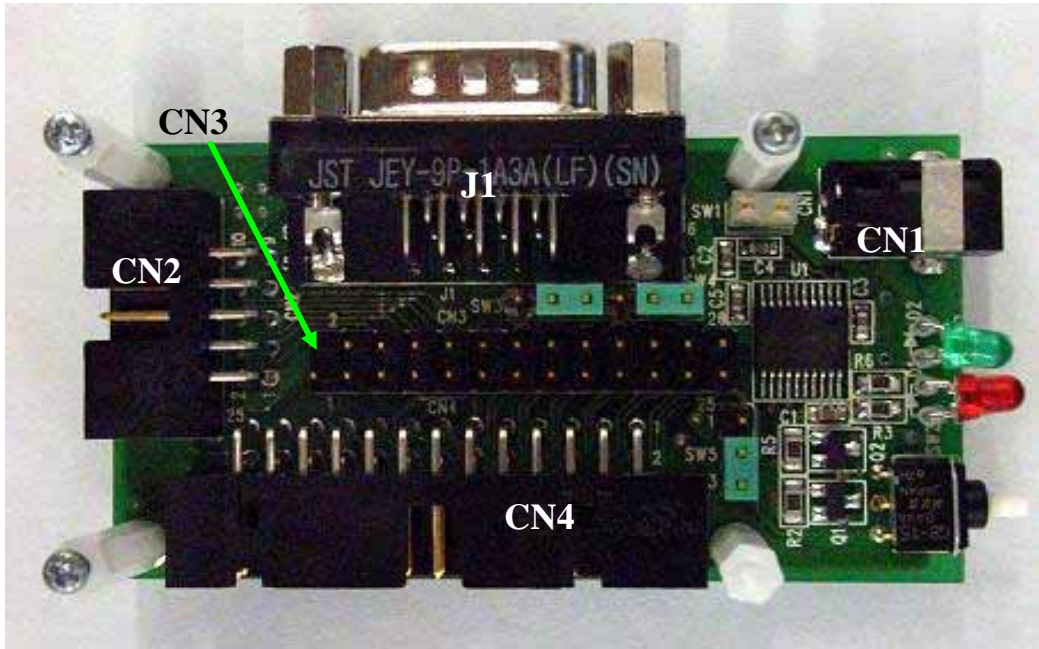

Figure 3: Connectors on the I/F board

4.7.1 Connector for connecting to external systems (CN4)

CN4 is a connector to connect EV5 to external systems. CN4 connects to free I/O pins on M16C/6S microcomputer. Configuration and functions of pins on CN4 are as follows.

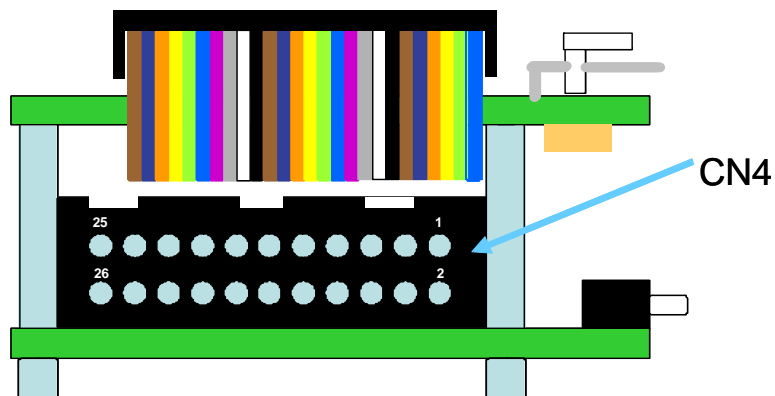

Figure 4: Pin configuration of CN4

As described above in [Figure 4](#), CN4 has a configuration on which the upper right pin is the 1st pin and the bottom left one is the 26th. For details about each pin, see [Table 4](#) on the next page.

Table 4: Description for pins of the connector CN4

Pin No. on CN4	I or O	Destination
1	5V	Inputs DC5V
2	3.3V	Outputs 3.3V which is generated by the evaluation board
3	GND	
4	I/O	Connects to M16C/6S Pin 25 (P64/CTS1/RTS1/CLKS1)
5	I/O	Connects to M16C/6S Pin 21 (P65/CLK1)
6	I/O	Connects to M16C/6S Pin 27 (P66/RXD1/SCL1)
7	I/O	Connects to M16C/6S Pin 15 (P15/INT3)
8	I	Connects to M16C/6S Pin 49 (CNVSS)
9	I/O	Connects to M16C/6S Pin 23 (P67/TXD1/SDA1)
10	RESET	Connects to M16C/6S Pin 20 (RESET)
11	I/O	Connects to M16C/6S Pin 22 (P92/SOUT3)
12	I/O	Connects to M16C/6S Pin 30 (P61/CLK0)
13	I/O	Connects to M16C/6S Pin 28 (P60/CTS0/RTS0)
14	I/O	Connects to M16C/6S Pin 24 (P91/SIN3)
15	I/O	Connects to M16C/6S Pin 26 (P90/CLK3)
16	I/O	Connects to M16C/6S Pin 32 (P63/TXD0/SD0)* ³
17	I/O	Connects to M16C/6S Pin 33 (P62/RXD0/SCL0)* ³
18	I/O	Connects to M16C/6S Pin 29 (P73/CTS2/RTS2/TA1IN)
19	O	Connects to M16C/6S Pin 31 (TS)* ⁴
20	I/O	Connects to M16C/6S Pin 16 (P80/TA4OUT)
21	I/O	Connects to M16C/6S Pin 34 (P83/INT1)
22	I/O	Connects to M16C/6S Pin 35 (P74/TA2OUT)
23	I/O	Connects to M16C/6S Pin 36 (P81/TA4IN) * ³
24	I/O	Connects to M16C/6S Pin 37 (P76/TA3OUT)
25	I/O	Connects to M16C/6S Pin 38 (P84/INT2)
26	GND	

*3: Destinations of P62, P63, and P81 are switched via selector switches SW3, SW4, and SW5.

In the initial setting of each switch, these pins are not connected to CN4.

To use P62, P63 and P81, please change the setting of SW3, SW4, and SW5. For details of each switch, refer to Page.13.

*4: TS is a control signal that outputs 3.3V when sending PLC signals.

4.7.2 Connector for on-chip debugging and flash writing (CN2)

CN2 is a 10-pin connector for on-chip debugging and flash writing. Connect it to an on-chip debugging emulator E8a (E8) after connecting the included 14PIN-10PIN convert board (R0KZC000000002R) to CN2.

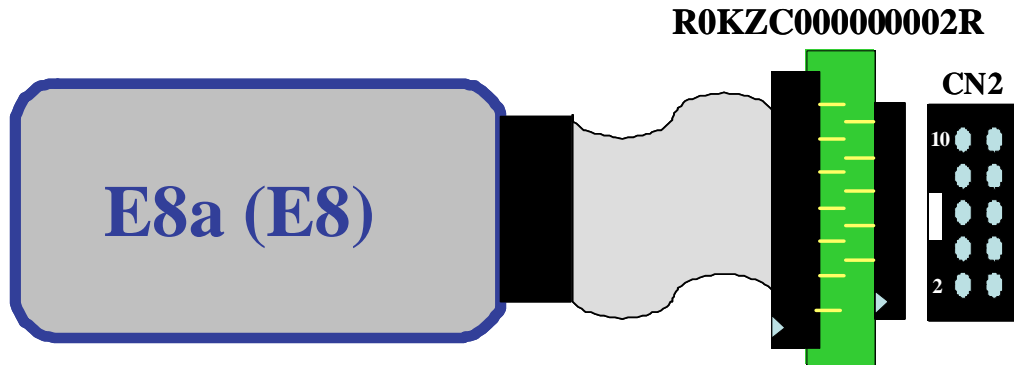

Figure 5: Connection between E8 and EV5

Table 5: Description for pins of the connector CN2

Pin No. on CN2	I or O	Destination
1	3.3V	Connects to 3.3V
2	I/O	Connects to M16C/6S Pin 25 (P64/CTS1/RTS1/CLKS1)
3	I/O	Connects to M16C/6S Pin 21 (P65/CLK1)
4	I/O	Connects to M16C/6S Pin 27 (P66/RXD1/SCL1)
5	I/O	Connects to M16C/6S Pin 15 (P15/INT3)
6	N.C	
7	GND	
8	RESET	Connects to M16C/6S Pin 20 (RESET)
9	I	Connects to M16C/6S Pin 49 (CNVSS)
10	I/O	Connects to M16C/6S Pin 23 (P67/TXD1/SDA1)

4.7.3 RS232-C interface connector to connect to a PC (J1)

J1 is a DSUB9-pin female connector to connect to a PC. It connects to M16C/6S via 232 driver on I/F module(Lower Board).

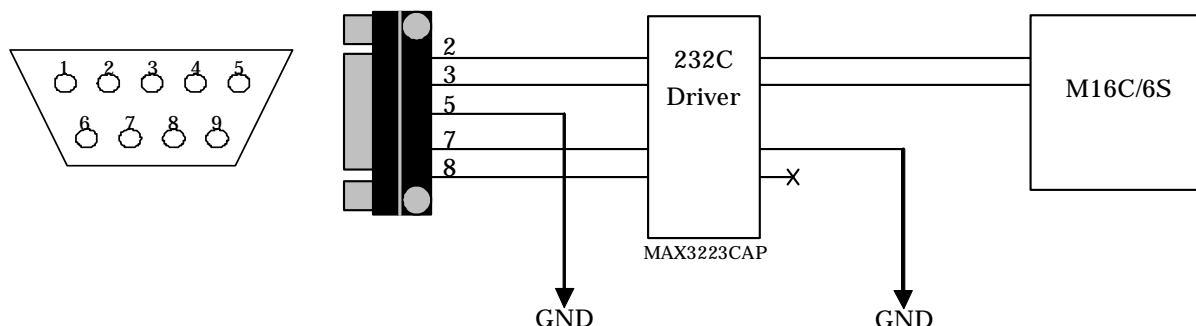

Figure 6: Connection diagram of J1

Table 6: Description for pins of the connector J1

Pin No. on J1	I or O	Destination
1	N.C	
2	I/O	Connects to M16C/6S Pin 33 (P62/RXD0/SCL0)* ⁵
3	I/O	Connects to M16C/6S Pin 32 (P63/TXD0/SDA0)* ⁵
4	N.C	
5	GND	
6	N.C	
7	GND	
8	N.C	
9	N.C	

*5: Destinations of P62 and P63 are switched via selector switches SW3 and SW4.
The initial setting of each switch does not connect with J1.
To use P62 and P63, please change the setting of SW3 and SW4.
For details of each switch, refer to Page.13.

4.7.4 Other connectors

CN3 is a connector to connect to a PLC module. Configuration and functions of pins on CN3 are the same as those of CN4. (see Page 8).

CN1 is an AC/DC adapter jack whose specification is as follows: (1) Inner core 1.7φ, (2) Outside diameter 4.0φ, (3) Input voltage-current DC5V/2A. It is also possible to supply 5V via CN4 without using an AC/DC adapter. When the short pin of SW1 is taken out, CN1 is disconnected from 5V line on the circuit.

4.8 Switches

This part explains switches of EV5.

4.8.1 Description of switches on the PLC module (the upper board)

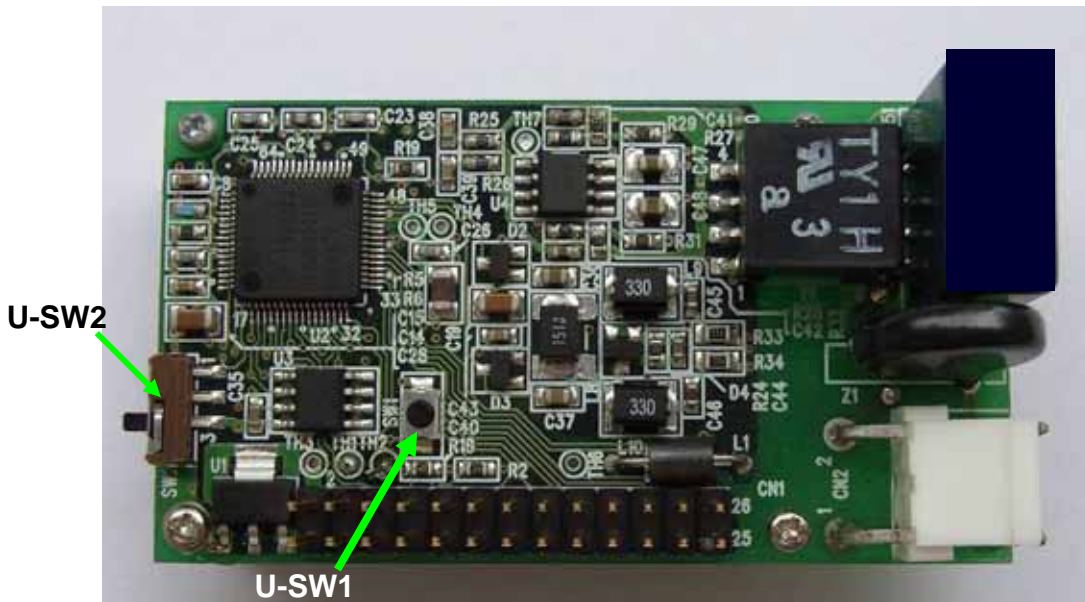
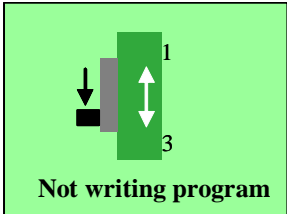
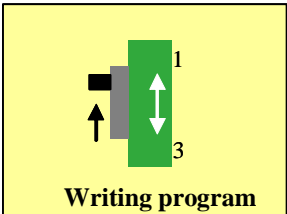

Figure 7: Location of switches on the upper board

Figure 7 is a picture of the upper board which has two switches, U-SW1 and U-SW2.

Table 7: Description of switches on the upper board

Number	Functions
U-SW1	Reset Switch for M16C/6S
U-SW2	<p>This switch is used only when M3A-0806 (TEN_NINE) shall be connected. U-SW2 is connected to CNVSS pin (49 pin) of M16C/6S</p> <p>In case of using E8a (E8), please fix U-SW2 as below left figure.</p> <p>In case of using M3A-0806, please set U-SW2 as below right figure during writing a program. Only when writing a program, please set U-SW2 as below right figure</p> <div style="display: flex; justify-content: space-around; align-items: center;"> <div style="text-align: center;">  <p>Not writing program</p> </div> <div style="text-align: center;">  <p>Writing program</p> </div> </div>

4.8.2 Description of switches on the dedicated interface board (the lower board)

This part describes switches on the dedicated interface board (the lower board).

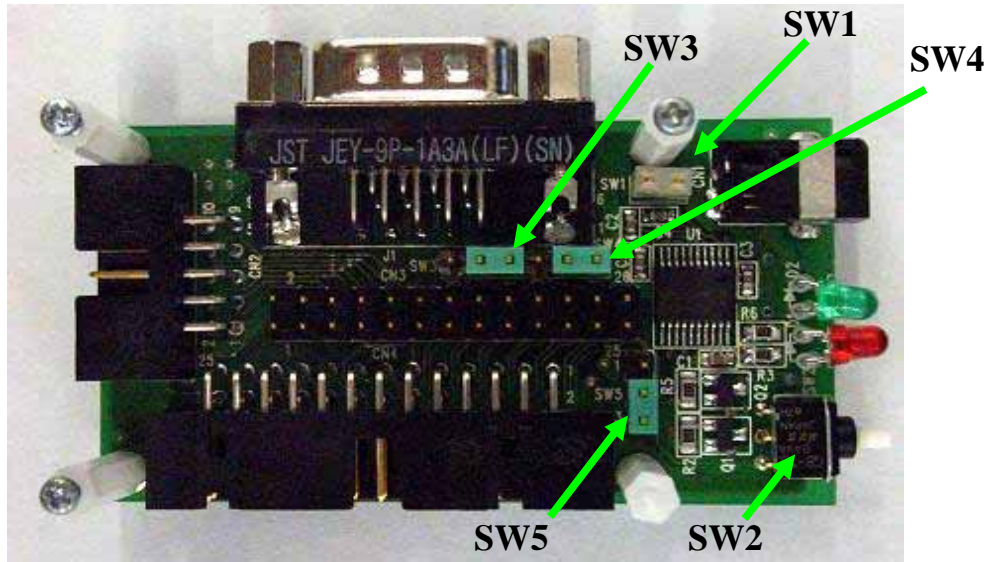







Figure 8: Switches on the dedicated interface board (the lower board)

Table 8: Description of switches on the dedicated interface board (the lower board)

Number	Functions
SW1	Selector plug switch for DC 5V power supply. In case that SW1 is on, please input DC5V via SW1. In case that SW1 is off, please input DC5V via the 1 st pin of CN4
SW2	Reset Switch for M16C/6S (Same as U-SW1)
SW3	Selector plug switch for P63  On the initial condition, P63 is connected to Pin3 of CN2 via 232C driver.  P63 is connected to Pin16 of CN4
SW4	Selector plug switch for P62  On the initial condition, P62 is connected to Pin2 of CN2 via 232C driver  P62 is connected to Pin17 of CN4
SW5	Selector plug switch for P81  On the initial condition, P81 is connected to circuits for green LED  P81 is connected to Pin23 of CN4

4.9 LED

EV5 has two LEDs to show the communication status of PLC.

Table 9: Description of LEDs

	Explanation
RED	Blink on and off when PLC module is sending PLC signal. RED LED's circuit is connected with "TS" control signal (Pin31 of M16C/6S) TS control signal outputs 3.3V during M16C/S sends PLC signal.
GREEN ^{*6}	When the setting is in the initial condition, GREEN LED's circuit is connected with P81 In the case of sample program, GREEN LED blinks on and off when M16C/6S received PLC signal.

*6: There may be rare occasions when not PLC data but noise makes the LED blink on and off .

4.10 AC Cables

EV5 has two AC cables. One is for under 125VAC with "A" type plug. Please select the cable after confirming the voltage in the use region.

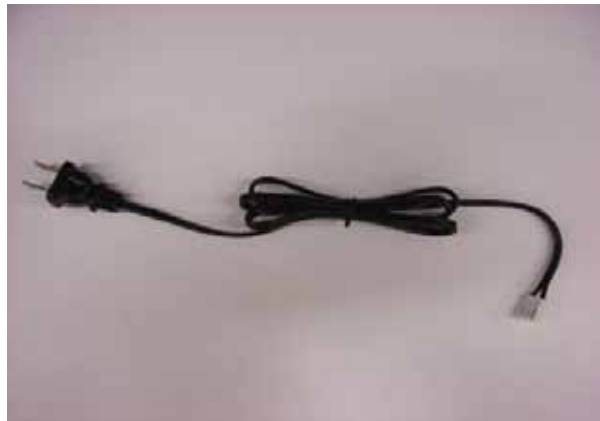

Figure 9: Cable for 125VAC

5. How to use the program for simple communication tests and software development environment

The following part explains how to use the included program for simple communication tests.

5.1 Environment for the usage of the program for simple communication tests.

The following [Figure 10](#) shows the environment for the usage of the program for simple communication tests. In case of using the program for PLC communication evaluation, the following items are required.

1. EV5: 2
2. PC to control EV5: 2

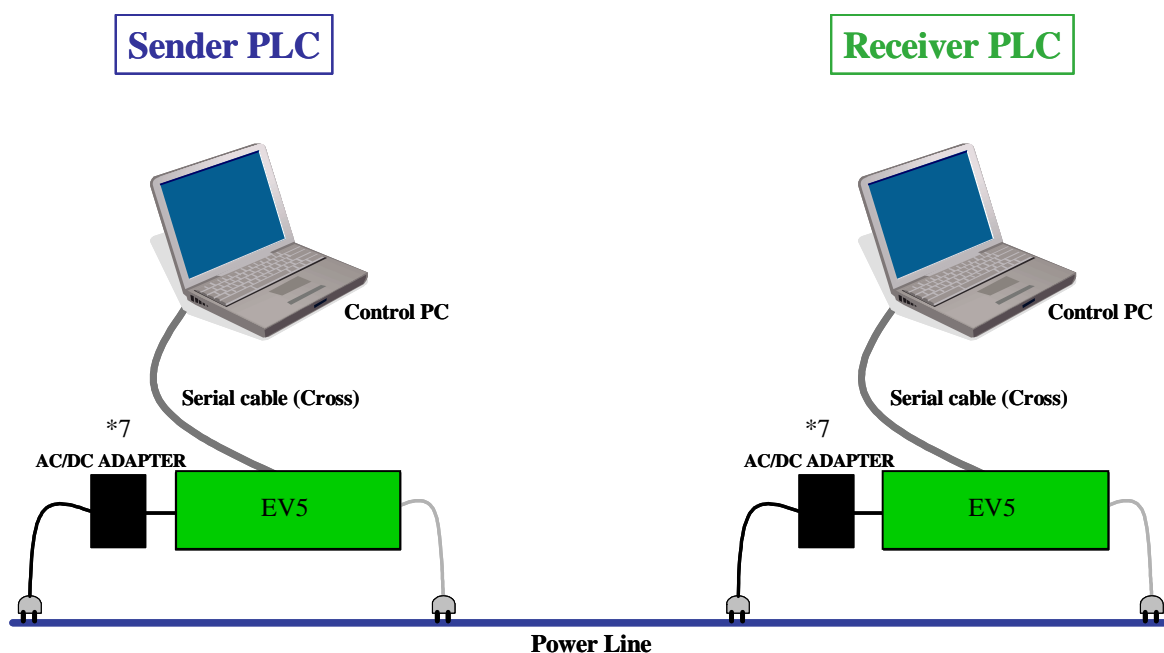

Figure 10: Environment for the usage of the program for simple communication tests

*7: In an environment where the communication condition is very severe, influence of the AC/DC adapter may affect the communication performance. In order to decrease the impact caused by AC/DC adapter, please connect the AC/DC adapter to other than outlet of PLC line.
In case that the AC/DC adapter can be suspected as a cause of a phenomenon, please try the above measures.

5.2 Start-up and execution of the program for simple communication tests

5.2.1 How to start the program for simple communication tests

After set up as shown in [Figure 10](#), establish the status of terminal software of both the sender and receiver and start the program.

The following explains how to start and execute the program by using terminal software, "Hyper Terminal" installed in Windows PCs.

- 1) Click "Start" left bottom of Windows desktop
- 2) Move the cursor to "All Programs", then sub window will appear on the screen.
- 3) Move the cursor to "Accessories" and to "Communications" on another sub window.
- 4) You can find "Hyper Terminal" icon on another window.
- 5) Click "Hyper terminal", then a new window as follows will appear on the screen.

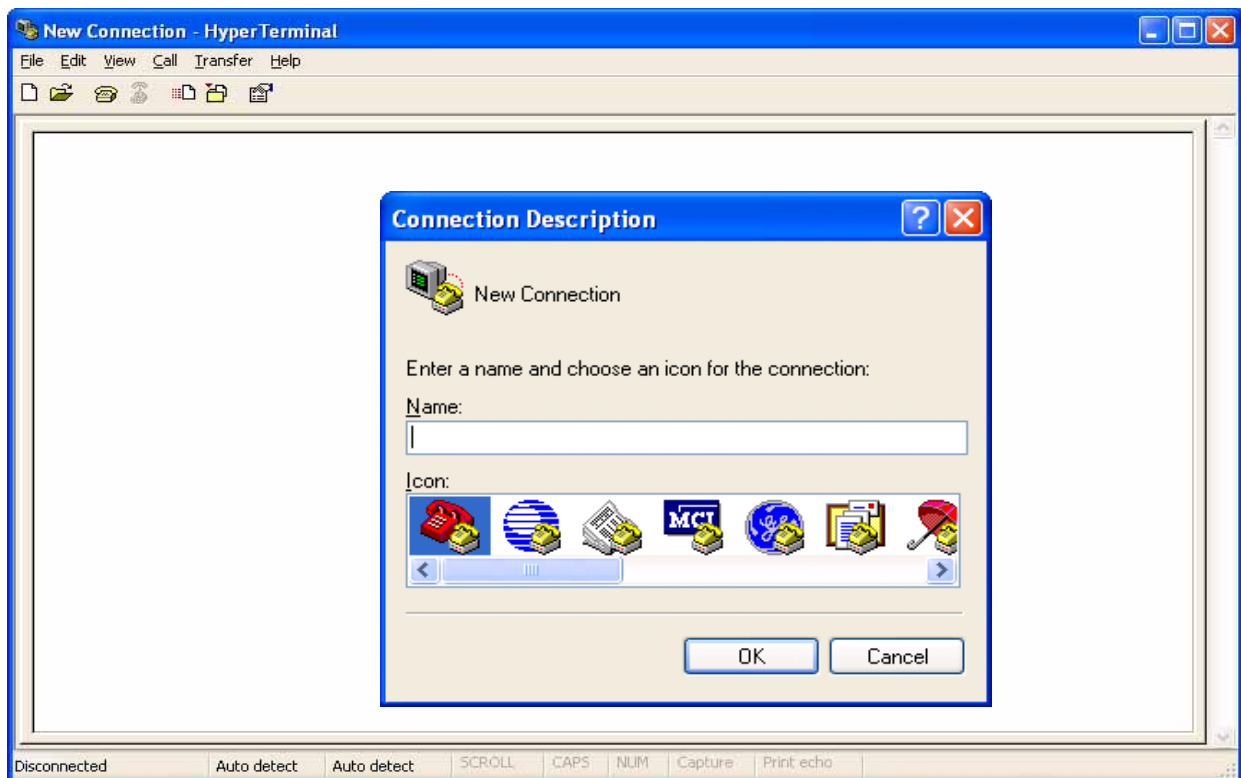

Enter an arbitrary name and choose an icon, then click “OK”.

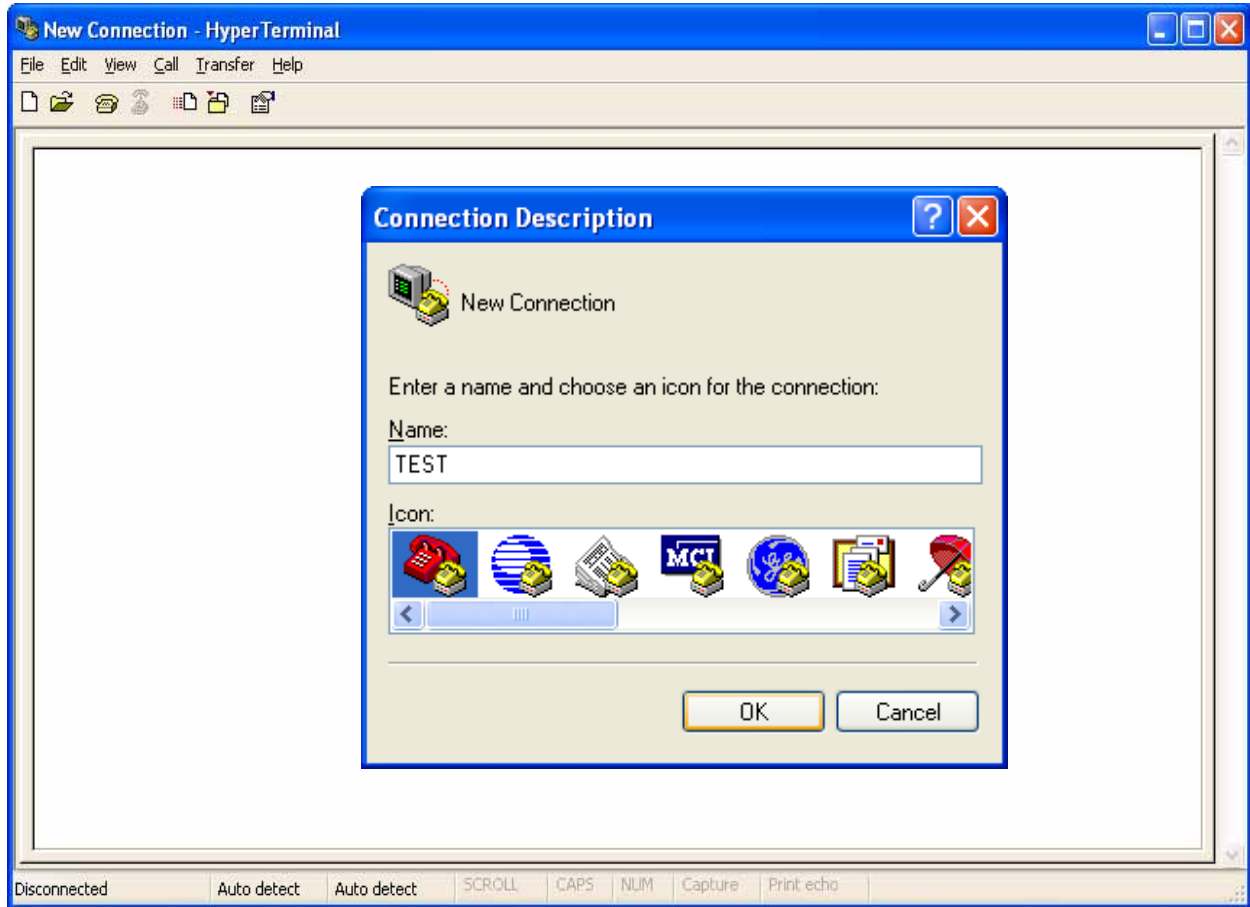

Another sub window as shown below will appear.

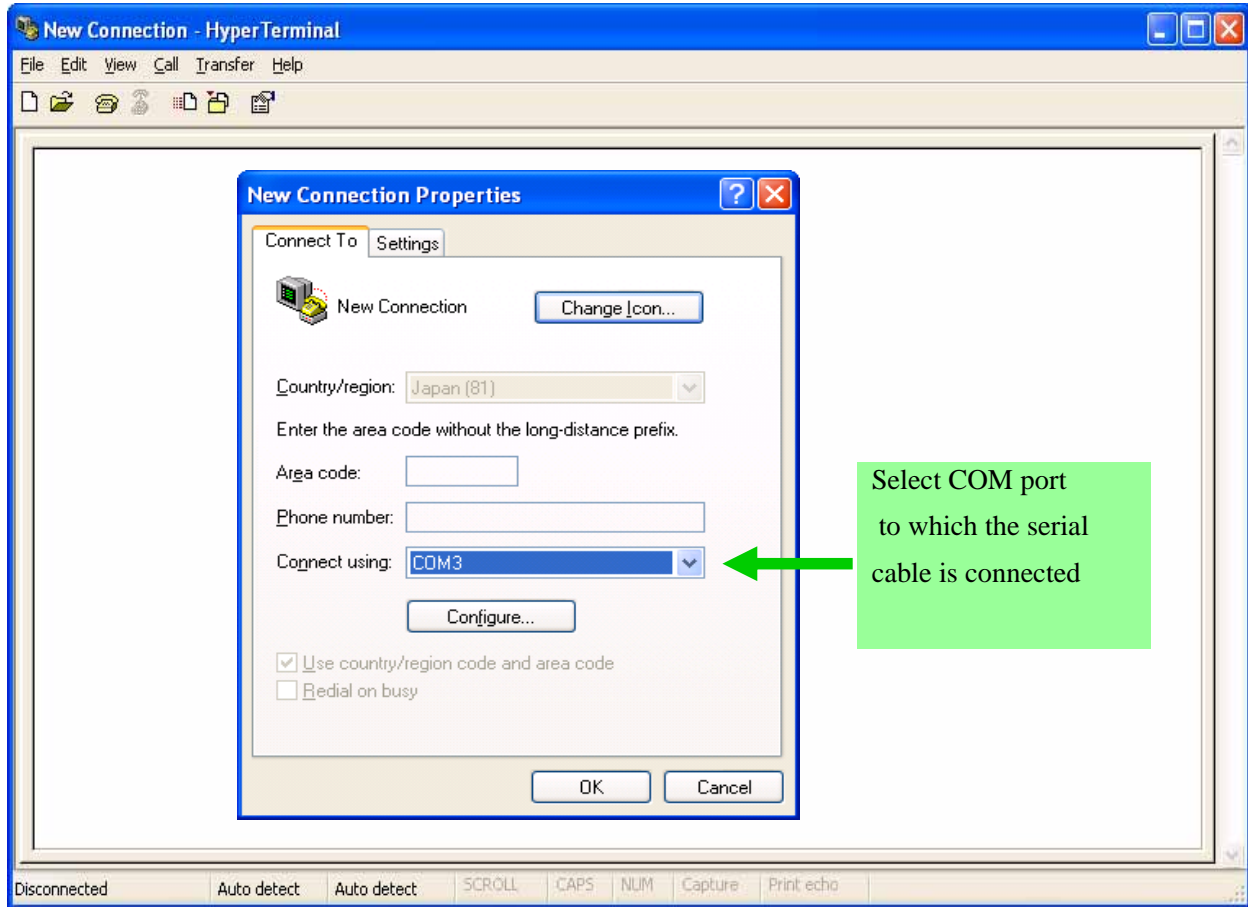

After checking that the COM port to which the serial cable is connected is selected as “Connect using”, click “OK”. Then the sub window as shown below will appear. Set each COM port condition as follows and click “OK”.

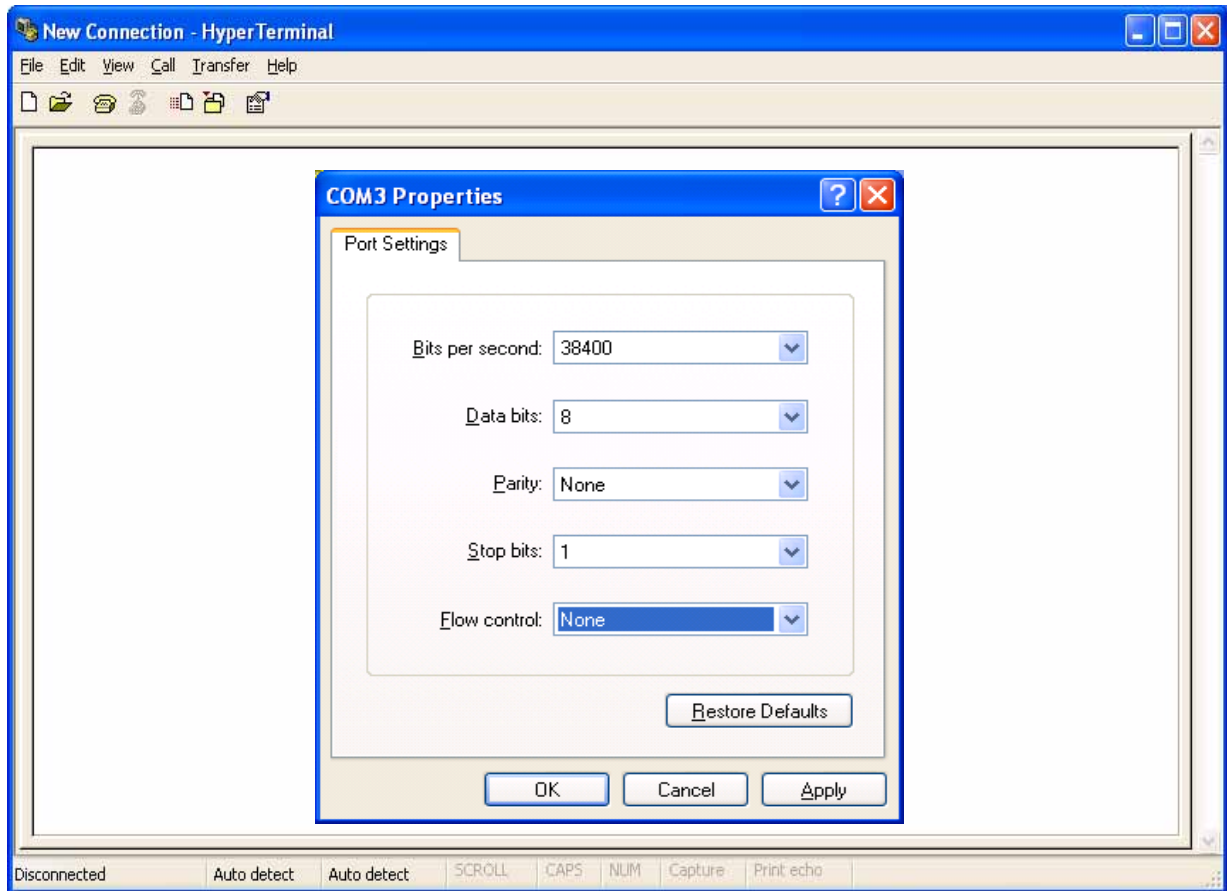

The COM setting window will be cleared, and only the terminal window will remain on the desktop. After that, push the reset switch of EV5 once. The program for simple communication tests will be started, and the following messages shown on the next page will appear on the terminal window.

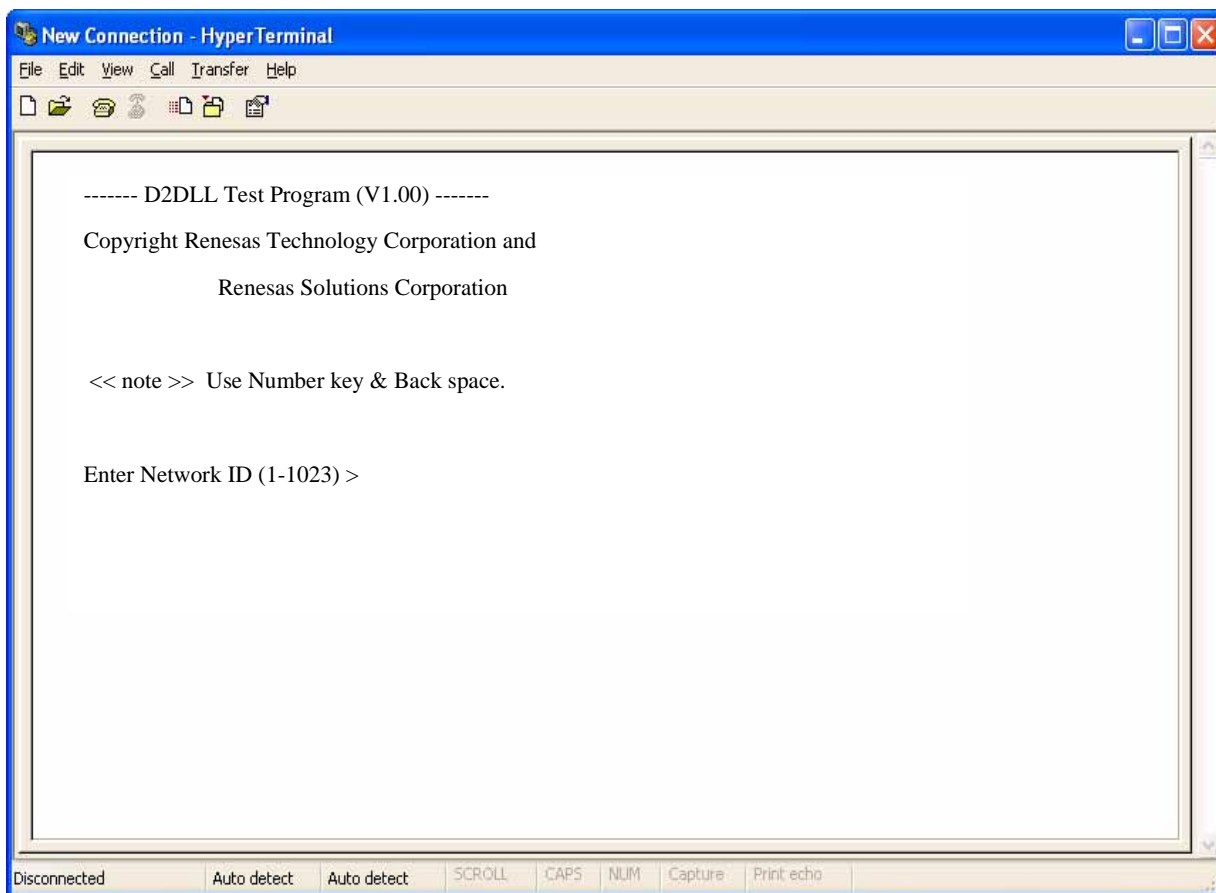

This will complete the start-up of the program for simple communication tests.

5.2.2 Setting procedure for the receiver

In case of using communication software, it is necessary to set a fixed ID to each node. Therefore different IDs should be set to the sender modem and the receiver modem respectively.

Set the receiver modem first. When the sample program is started, the following message will appear.

Enter Network ID (1-1023) >

Input an arbitrary number and press the return key. (The number input here is to be the network ID number.)
The following message appears now.

Enter Source Node ID (1-2047) >

Input an arbitrary number and press the return key again. (The number input here is to be the ID number of the sender PLC modem.) The following message appears next.

Enter Destination Node ID (1-2047) >

Input an arbitrary number which is different from the above, and press the return key. (The number input here is to be the ID number of the receiver PLC modem.)

When the procedure has been completed, dedicated middleware D2DL for PLC communication would be initialized. After the initialization, the display on the terminal will change as follows.

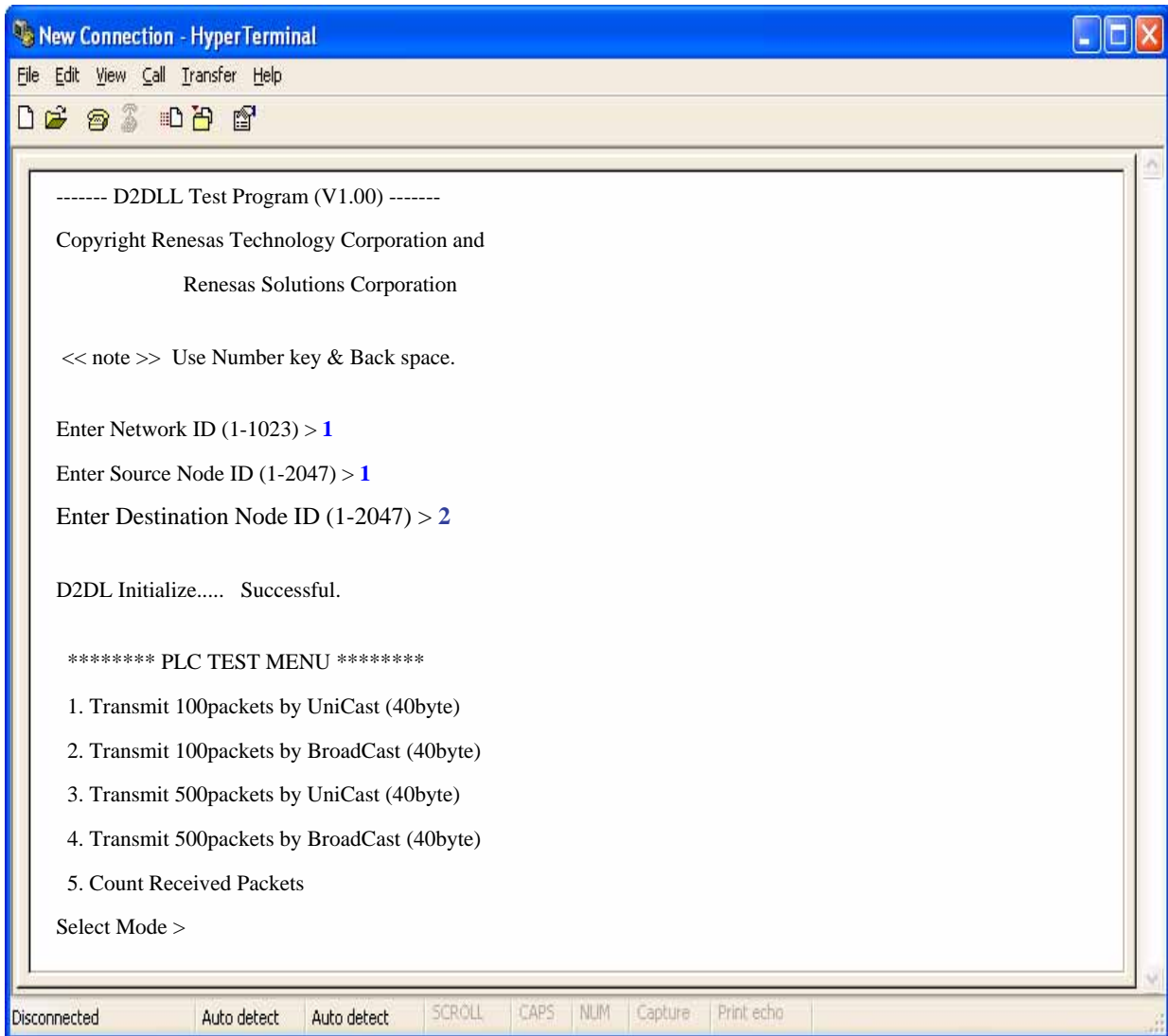

Select 5 among the PLC TEST MENU and press the return key.

EV5 will change into a standby state for reception. Once the return key is pressed again, the number of packets received from an arbitrary node.

This will complete the setting procedure for the receiver.

5.2.3 Setting procedure for the sender

In the setting for the sender, enter the same network ID as the receiver's, and set the opposite numbers to Source ID and Destination ID from those of the receiver.

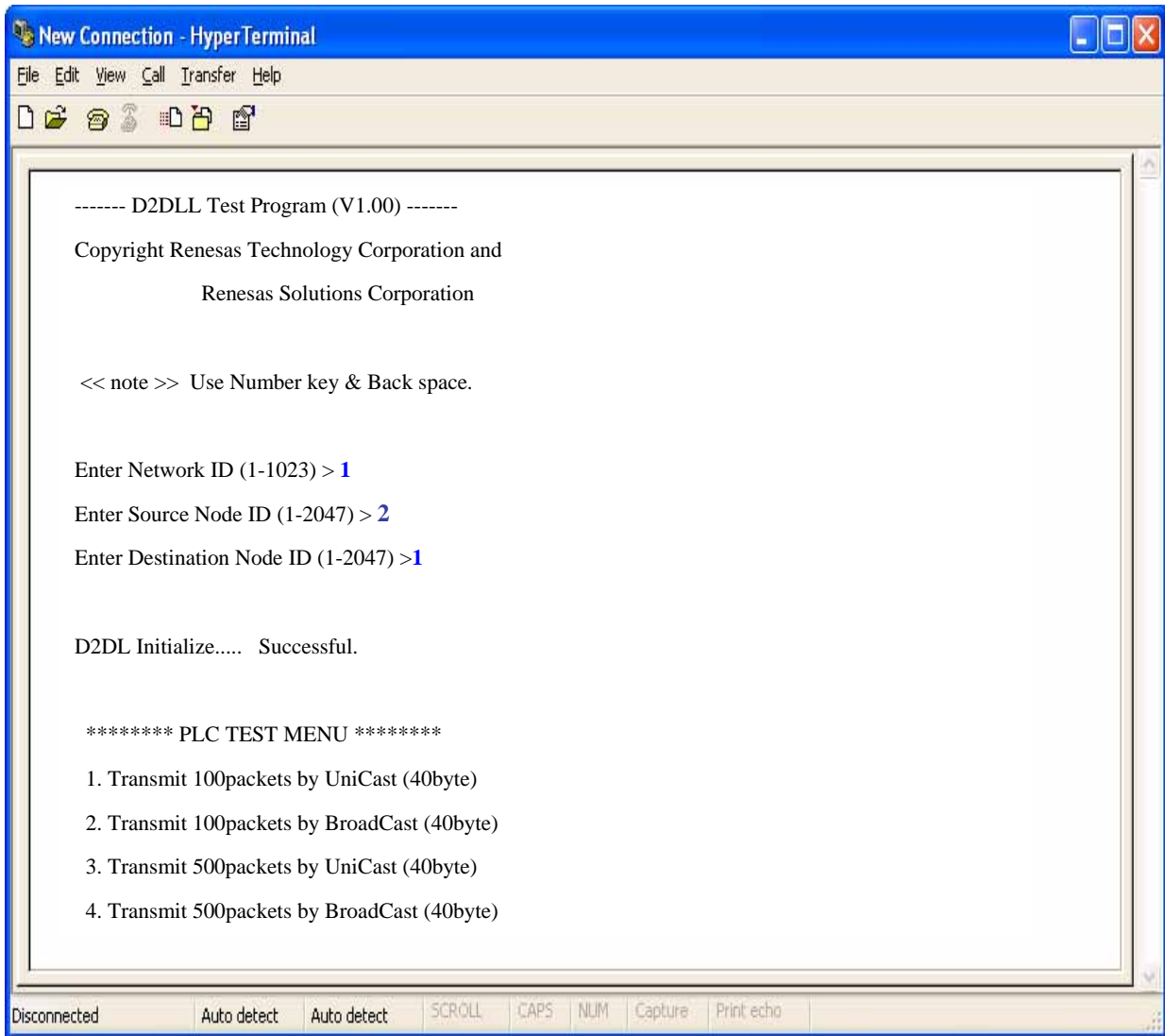

After setting IDs, select a transmit mode from 1 to 4. Press the return key, and the transmission starts. When the transmission has been completed, a message showing the completion will appear on the above window. Once this message appears, the number of the received packets can be checked by pressing the return key on the receiver PC. This is a sequence of the sample program.

5.2.4 Transmission modes (Unicast and Broadcast)

The below Table 10 summarizes the difference between unicast and broadcast. Note that the transmit mode and the re-transmit times in the table depend on the program development, so that they can be changed.

Unicast communication is a 1-to-1 communication method in which data is sent to a specified node to communicate with. The data (No. x^{th}) receiver node returns an acknowledge to the data sender node. When the sender receives the acknowledge, it sends the next data (No. $x+1^{\text{th}}$). If it cannot receive the acknowledge within a defined period, it will send the same data (No. x^{th}) again. Re-transmit times are twice. After sending twice, the sender will send the next data (No. $x+1^{\text{th}}$) regardless of the acknowledge.

In unicast communication, “adaptive rate control”(ARC) function is adopted, in which the transmission mode is automatically switched depending on the status of the transmission channel. At first, ARC transmits data in SM mode of 7.5Kbps. And, if the acknowledge from the receiver does not come back, ARC shifts the transmit mode automatically to RM mode of 5.0Kbps. In addition, when the acknowledge cannot be received even in RM mode, ARC shifts the mode to ERM mode of 1.25Kbps. Moreover, when the acknowledge can be continuously received twice or more times in ERM mode, it is judged that the status of the transmission channel has recovered, and the mode returns to RM mode. In a similar way, when the acknowledge can be continuously received twice or more times in RM mode, the mode returns to SM mode.

Broadcast communication is a 1-to-many communication method in which data can be sent to all nodes at a time in the network without specifying a node to communicate with. The data receiver nodes do not send back the acknowledge in spite of the data reception. Therefore adaptive rate control function is not supported in broadcast communication. The data transmit mode is fixed to RM mode of 5.0Kbps, and re-transmission is not performed.

Table 10: Difference between Unicast and Broad cast

	Unicast	Broadcast
Communication method	1 to 1	one to many
Transmit mode* ⁸	Adaptive rate control	RM mode fixed
Acknowledge from Receiver	Yes	No
Re-transmit times* ⁸	Twice	0
Menu number	1 and 3	2 and 4

*8:They depend on the application program development , so that they can be changed.

For more details, please contact csc@renesas.com which is introduced in 4.5.

5.3 Sample Test Program's ID Code

EV5 is shipped with sample test program written in the flash memory of M16C/6S.

The ID code for protecting it written in flash memory is "00000000000000"(all zeros).

Please input all zeros on the input screen as shown in the figure below, when you debug or write your program to the flash memory of M16C/6S using E8a/E8.

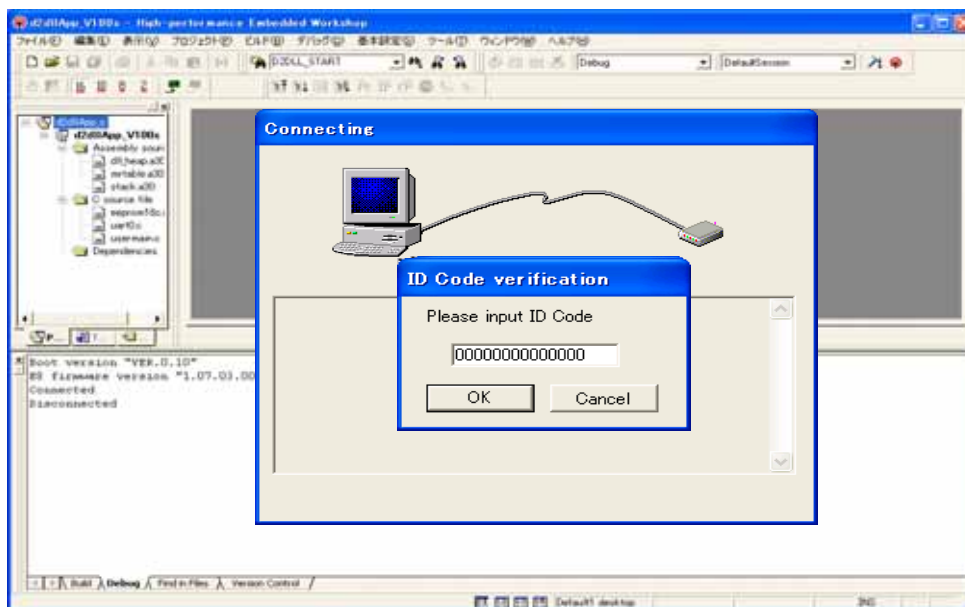

5.4 Software Developing Environment

Environment to develop a PLC communication application using EV5 is as follow.

1. Integrated Development Environment (IDE) High-performance Embedded Workshop*⁹*¹⁰
2. C compiler M3T-NC30WA Ver5.40
3. On-chip Emulator E8a/E8
4. Debugger GUI (Integrated in 1) E8a/E8 Emulator software*⁹
5. Flash program software FDT*⁹
6. E8a/E8 14PIN-10PIN Convert Board R0KZC00000002R (Included in this product)
7. Data Link Layer Library D2DL*¹¹

*⁹ It is included in C compiler package software.

*¹⁰ It can be free downloaded from RENESAS Web Site.

*¹¹ Renesas offers free D2DL individually. Please contact csc@renesas.com

For more details about D2DL, please access the URL as follows.

http://japan.renesas.com/fmwk.jsp?cnt=m16c6s_root.jsp&fp=/products/mpumcu/plc_mpumcu/m16c60_plc_series/m16c6s_group/

All trademarks and registered trademarks are the property of their respective owners.

WINDOWS is the trademark and property of Microsoft Corporation in the United States.

Notes regarding these materials

1. This document is provided for reference purposes only so that Renesas customers may select the appropriate Renesas products for their use. Renesas neither makes warranties or representations with respect to the accuracy or completeness of the information contained in this document nor grants any license to any intellectual property rights or any other rights of Renesas or any third party with respect to the information in this document.
2. Renesas shall have no liability for damages or infringement of any intellectual property or other rights arising out of the use of any information in this document, including, but not limited to, product data, diagrams, charts, programs, algorithms, and application circuit examples.
3. You should not use the products or the technology described in this document for the purpose of military applications such as the development of weapons of mass destruction or for the purpose of any other military use. When exporting the products or technology described herein, you should follow the applicable export control laws and regulations, and procedures required by such laws and regulations.
4. All information included in this document such as product data, diagrams, charts, programs, algorithms, and application circuit examples, is current as of the date this document is issued. Such information, however, is subject to change without any prior notice. Before purchasing or using any Renesas products listed in this document, please confirm the latest product information with a Renesas sales office. Also, please pay regular and careful attention to additional and different information to be disclosed by Renesas such as that disclosed through our website. (<http://www.renesas.com>)
5. Renesas has used reasonable care in compiling the information included in this document, but Renesas assumes no liability whatsoever for any damages incurred as a result of errors or omissions in the information included in this document.
6. When using or otherwise relying on the information in this document, you should evaluate the information in light of the total system before deciding about the applicability of such information to the intended application. Renesas makes no representations, warranties or guaranties regarding the suitability of its products for any particular application and specifically disclaims any liability arising out of the application and use of the information in this document or Renesas products.
7. With the exception of products specified by Renesas as suitable for automobile applications, Renesas products are not designed, manufactured or tested for applications or otherwise in systems the failure or malfunction of which may cause a direct threat to human life or create a risk of human injury or which require especially high quality and reliability such as safety systems, or equipment or systems for transportation and traffic, healthcare, combustion control, aerospace and aeronautics, nuclear power, or undersea communication transmission. If you are considering the use of our products for such purposes, please contact a Renesas sales office beforehand. Renesas shall have no liability for damages arising out of the uses set forth above.
8. Notwithstanding the preceding paragraph, you should not use Renesas products for the purposes listed below:
 - (1) artificial life support devices or systems
 - (2) surgical implantations
 - (3) healthcare intervention (e.g., excision, administration of medication, etc.)
 - (4) any other purposes that pose a direct threat to human life

Renesas shall have no liability for damages arising out of the uses set forth in the above and purchasers who elect to use Renesas products in any of the foregoing applications shall indemnify and hold harmless Renesas Technology Corp., its affiliated companies and their officers, directors, and employees against any and all damages arising out of such applications.
9. You should use the products described herein within the range specified by Renesas, especially with respect to the maximum rating, operating supply voltage range, movement power voltage range, heat radiation characteristics, installation and other product characteristics. Renesas shall have no liability for malfunctions or damages arising out of the use of Renesas products beyond such specified ranges.
10. Although Renesas endeavors to improve the quality and reliability of its products, IC products have specific characteristics such as the occurrence of failure at a certain rate and malfunctions under certain use conditions. Please be sure to implement safety measures to guard against the possibility of physical injury, and injury or damage caused by fire in the event of the failure of a Renesas product, such as safety design for hardware and software including but not limited to redundancy, fire control and malfunction prevention, appropriate treatment for aging degradation or any other applicable measures. Among others, since the evaluation of microcomputer software alone is very difficult, please evaluate the safety of the final products or system manufactured by you.
11. In case Renesas products listed in this document are detached from the products to which the Renesas products are attached or affixed, the risk of accident such as swallowing by infants and small children is very high. You should implement safety measures so that Renesas products may not be easily detached from your products. Renesas shall have no liability for damages arising out of such detachment.
12. This document may not be reproduced or duplicated, in any form, in whole or in part, without prior written approval from Renesas.
13. Please contact a Renesas sales office if you have any questions regarding the information contained in this document, Renesas semiconductor products, or if you have any other inquiries.

EV5 (US Edition) -R0K3306S0D010BR- User's Manual

Publication Date: Rev.1.2, May 20, 2009

Published by: Renesas Technology Corp.

Edited by: Consumer MCU Application Engineering Department Renesas Solutions Corp

@2009.Renesas Technology Corp and Renesas Solutions Corp, All rights reserved. Printed in Japan
