

QCIOT-013-28022POCZ

QCIOT-013 Digital Power Monitor Board

The QCIOT-013 Digital Power Monitor (DPM) Board demonstrates the functionality and performance of the ISL28022 Digital Power Monitor. The ISL28022 is used to measure the current and voltage through the shunt resistor to determine the power on the line. The design of the DPM board is generic so that the customer can embed the monitor into their specific application.

The board provides a standard Pmod™ Type 6A (extended I<sup>2</sup>C) connection for the onboard sensor to plug into any required MCU evaluation kit with a matching connector. The QCIOT-013 board features Pmod connectors on both sides of the board to allow additional Type 6/6A boards to connect in a daisy-chained solution with multiple devices on the same MCU Pmod connector.

The software support included with the Renesas IDE (e<sup>2</sup> studio) allows for code generation to connect the device and the MCU so that development time is significantly reduced. With its standard connector and software support, the QCIOT-013 board is ideal for the Renesas Quick-Connect IoT to rapidly create an IoT system.

**Features**

- 0V to 60V bus voltage sense range
- Variable current sense range with on-board shunt resistor or external shunt resistor
- 16-bit ΣΔADC monitors current and voltage
- System voltage/current monitoring with efficiency reporting
- Overvoltage/undervoltage and current fault monitoring
- Standardized type 6A Pmod connector supports I<sup>2</sup>C/SMBUS extended interface
- Dual connectors allow pass-through signals for daisy-chained solution
- Software support in e<sup>2</sup> studio minimizes development time with one-click code generation

**Board Contents**

- QCIOT-013 Digital Power Monitor Board

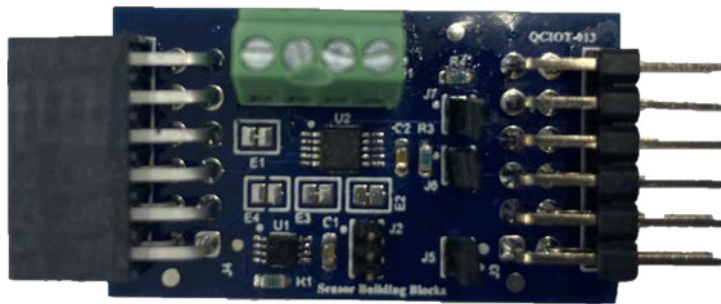

Figure 1. QCIOT-013 Digital Power Monitor Board Image

## Contents

<b>1. Functional Description</b>	<b>3</b>
1.1 Operational Characteristics	3
1.2 Setup and Configuration	5
<b>2. Board Design</b>	<b>7</b>
2.1 Schematic Diagrams	8
2.2 Bill of Materials	10
2.3 Board Layout	11
<b>3. Software Design</b>	<b>12</b>
3.1 Project Code Structure	12
3.2 Software Module Overview	15
3.3 User Settings	19
3.4 Board Test	20
<b>4. Ordering Information</b>	<b>27</b>
<b>5. Revision History</b>	<b>27</b>

# 1. Functional Description

The QCIOT-013 DPM Board is intended as a quick-connect prototyping solution for a digital power monitoring. This board can enable the designer to quickly evaluate applications where higher voltage and current require monitoring. The QCIOT-013 board can measure voltages in the presence of common-mode voltages ranging 0V to 60V, and it can measure the variable input current and power consumption. The board can also report diagnostics by configuring the fault thresholds of the bus voltage and shunt voltage.

Figure 2 highlights the main parts of the system:

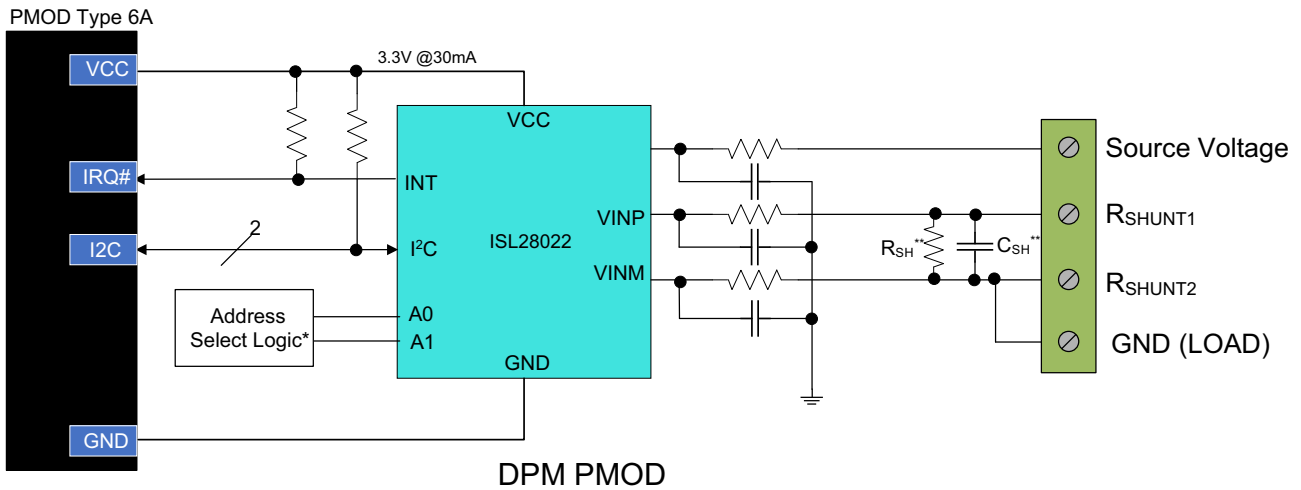

\* Design Detail, usually 0Ω resistors

\*\*  $R_{SH}$  and  $C_{SH}$  are footprints for optionally mounting on the PMOD. Since these can be large and dissipate considerable power, on-board RC will be limited in its capabilities.

Figure 2. QCIOT-013 Digital Power Monitor Board Block Diagram

The following details the building block of the QCIOT-013 DPM Board and its functionality:

- ISL28022 – Bidirectional high-side and low-side digital current sense and voltage monitor with a serial interface. The device monitors shunt and bus voltage, and provide calculated current and power as a digital number. The ISL28022 provides an accuracy of less than 0.3% for both voltage and current monitoring.

## 1.1 Operational Characteristics

The QCIOT-013 Board can be used as a starting point for DC power distribution, whether in high voltage industrial or battery powered applications.

The board has been designed to the following specifications:

- Input voltage range = 0V - 60V
- Voltage measuring error < 0.3%
- Current measuring error < 0.3%

### 1.1.1 Input Bus Voltage Measurement

The ISL28022 measures bus voltage and current sequentially. It consists of a two-channel analog front end multiplexer, a 16-bit sigma delta ADC and digital signal processing/serial communication circuitry. The selection to the input of the ADC is either a single-ended VBUS measurement or a fully differential measurement across a shunt resistor.

The ISL28022 can monitor supplies from 0V to 60V while operating on a chip supply ranging from 3V to 5.5V. The measurable bus voltage range, 16V, 32V, or 60V, can be set by the Configuration register.

The bus voltage can be calculated by the [Equation 1](#).

$$(EQ. 1) \quad V_{bus} = \left[ \sum_{n=2}^{15} (\text{Bit}_n \cdot \text{Bit\_Weight}_n) \right] \cdot V_{bus\_LSB}$$

[Equation 1](#) is the mathematical equation for converting the binary VBUS value to a decimal value. N is the bit number. The LSB value  $V_{bus\_LSB}$  of the bus voltage measurement equals 4mV across all settings.

## 1.1.2 Current Measurement

The ISL28022 is capable of measuring bidirectional currents while monitoring the bus voltage. The ISL28022 requires an external shunt resistor to enable current measurements. The shunt resistor translates the bus current to a voltage. The ISL28022 measures the voltage across the shunt resistors and reports the measured value out digitally through an I<sup>2</sup>C interface. The stored current sense resistor value allows the ISL28022 to output the current value to an external digital device.

Either the onboard shunt resistor or external shunt resistor can be used for current measurement on the QCIOT-013 board. The onboard shunt resistor is not populated by default.

### 1.1.2.1 Shunt Resistor Selection

In choosing a sense resistor, the following resistor parameters must be considered: the resistor value, resistor temperature coefficient, and the resistor power rating.

Refer to the Shunt Resistor Selection section in the *ISL28022 Datasheet* for more detail.

The max measured current is limited by the shunt voltage range selection, shunt resistor value, and resistor power rating. **Warning:** With the QCIOT-013 board, if you choose to use the onboard resistor, the maximum measured current is 3A, so a current above 3A might damage the board.

### 1.1.2.2 Current Measurement

The full-scale current range can be calculated using [Equation 2](#).  $R_{shunt}$  is the value of the shunt resistor.  $V_{shunt\_FS}$  is the full-scale setting that is required. In most cases, the DPM is programmed to the PGA full-scale range (320mV, 160mV, 80mV, and 40mV).

$$(EQ. 2) \quad \text{Current}_{FS} = \frac{V_{shunt\_FS}}{R_{shunt}}$$

From the current full-scale range, the current LSB is calculated using [Equation 3](#). Current full-scale is the outcome from [Equation 2](#).  $ADC_{res}$  is the resolution of shunt voltage reading. The value is determined by the SADC setting in Configuration register.

$$(EQ. 3) \quad \text{Current}_{LSB} = \frac{\text{Current}_{FS}}{ADC_{res}}$$

From [Equation 3](#), the calibration register value is calculated using [Equation 4](#). The resolution of the math that is processed internally in the DPM is 4096 or 12 bits of resolution. The  $V_{shunt\_LSB}$  is set to 10 $\mu$ V. [Equation 4](#) yields a 16-bit binary number that can be written to the calibration register.

$$(EQ. 4) \quad \text{CalReg}_{val} = \text{Integer} \left[ \frac{\text{Math}_{res} \cdot V_{shunt\_LSB}}{\text{Current}_{LSB} \cdot R_{shunt}} \right]$$

When the calibration register (05h) is programmed, the output current is calculated using [Equation 5](#):

$$(EQ. 5) \quad \text{Current} = \left[ \sum_{n=0}^{15} (\text{Bit}_n \cdot \text{Bit\_Weight}_n) \right] \cdot \text{Current}_{\text{LSB}}$$

### 1.1.3 Power measurement

The Power register only has meaning if the calibration register (05h) is programmed. The units for the power register are in watts. The power is calculated using [Equation 6](#):

$$(EQ. 6) \quad \text{Power} = \left[ \sum_{n=0}^{15} (\text{Bit}_n \cdot \text{Bit\_Weight}_n) \right] \cdot \text{Power}_{\text{LSB}} \cdot 5000$$

Bit is the returned value of each bit from the power register either 1 or a 0. The weight of each bit is represented with 1,2,4... n is the bit number. The power LSB is calculated from [Equation 7](#):

$$(EQ. 7) \quad \text{Power}_{\text{LSB}} = \text{Current}_{\text{LSB}} \cdot \text{Vbus}_{\text{LSB}}$$

If VBUS range, BRNG, is set to 60V, the power equation in [Equation 6](#) is multiplied by 2.

### 1.1.4 Fault Monitoring

The ISL28022 can set thresholds for overvoltage and undervoltage of the bus voltage. With the known shunt resistor, the current threshold can be set by programming the overvoltage and undervoltage threshold register.

Measurement readings exceeding the respective VSHUNT or VBUS threshold, either above or below, set a register flag and perhaps an external interrupt depending on the configuration of the Interrupt Enable bit (INTREN) in register 09h.

## 1.2 Setup and Configuration

Required or Recommended User Equipment – The following additional lab equipment is required for using the board (and is sold separately):

- Renesas Fast Prototyping Board: FPB-RA4E1
- USB micro-B cable (provided with FPB board)
- USB port isolator (Optional, sold by third party supplier)
- PC running Windows 10/11 with at least one USB port.
- DC Power supply (0 to 60V output)
- Shunt resistor and load resistor

Required or Recommended software

- Renesas Flexible Software Package v4.5.0 platform installation:
  - e2 studio 2023-01 or later
  - FSP 4.5.0 or later
  - GCC Arm Embedded 10.3.1 (10 2021.10) or later
- Sample code files (available on the web page for this device on the Renesas Website)

### 1.2.1 Software Installation and Usage

Visit the Renesas website for the latest version of the e2 studio [installer](#). The minimum FSP version supporting the QCIOT-013 board is FSP 4.5.0.

## 1.2.2 Kit Hardware Connections

Follow these procedures to set up the kit (see [Figure 3](#)).

1. Ensure that the MCU development kit in use has two Type 6A Pmods.
  - a. For FPB-RA4E1, two Pmods are available, PMOD1 and PMOD2.
  - b. For the kit other than FPB-RA4E1, if no Type 6A Pmod is available, ensure that the kit can use the US082-INTERPEVZ interposer board. Insert the board into the MCU connector before adding any sensor boards.
2. Ensure that the pin12 of Pmod is 3.3V, which is requested by QCIOT-013.
  - a. For FPB-RA4E1 and FPB-RA6E1, the Pin 12 of Pmod is 5V by default. The trace jumper E1 should be short and E2 should be open to get 3.3V on Pmod1.
  - b. For some evaluation boards, the Pin 12 of Pmod is 3.3V by default. No change is required. Check the user manual before using it.
3. Mount the J4, J5, and J6 jumpers on QCIOT-013.
  - a. Only one set of I<sup>2</sup>C pull-up resistors should be used on the bus. If multiple Pmod connected boards are used, only one board should have the jumpers present.
  - b. If multiple modules use the IRQ# line on the PMOD, only one pull-up jumper should be present.
  - c. MCU kits typically do not have pull-up resistors present on the bus lines, but ensure to check for them.
4. Connect the current shunt resistor (see the section [Shunt Resistor Selection](#)).
  - a. If you choose to use the onboard resistor Rs, which is not populated, be aware that the max input current is 3A.
  - b. If you choose to use the external shunt resistor, connect the terminal of shunt resistor to VINP and VINM of J1 using wires or terminal pins. If using wires, ensure the wire gauge is a sufficient thickness to carry the operating current load.
5. Turn off your power source to be measured. Next, connect the measured power source to VBUS and GND of screw terminal connector J1. VBUS should be between 0V to 60V.  
Max current load:
  - a. If you choose to use the onboard resistor Rs, the max input current should be less than 3A.
  - b. If you choose to use the external shunt resistor, the max input current is decided by the shunt resistor.
6. Short VBUS pin and VINP pin using wires. Ensure the wire gauge is a sufficient thickness to carry the operating current load.
7. Plug in the QCIOT-013 Board to PMOD1 connector of FPB4AE1. Be careful to align Pin 1 on the power board and MCU kit.
8. Connect FPB board with computer with USB micro-B cable. The USB isolator is recommended to protect your computer's USB port.
9. The device is now ready to be used in the system. (See [User Settings](#) for board test.)

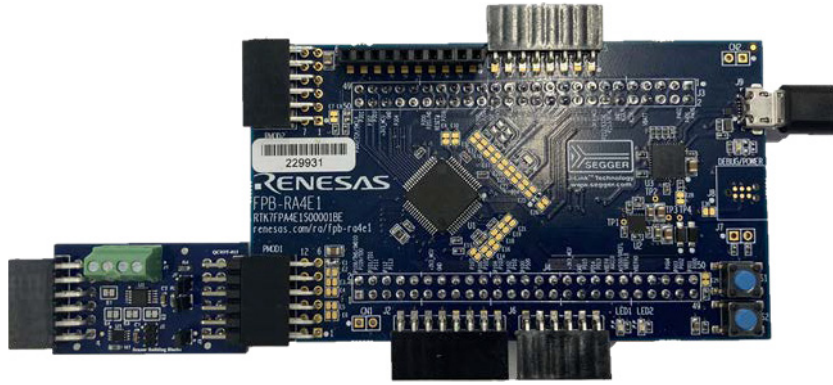

Figure 3. QC10T-013 Power Monitor Board with FPB-RA4E1 MCU Kit

### 1.2.3 I2C Address Select

The QC10T-013 board has a default I<sup>2</sup>C address of 1000 000 for binary, 0x40 for the 7-bit address. If this is in conflict with another device on the I<sup>2</sup>C line, the user can change the I<sup>2</sup>C address by changing E1 and E2 on the board. To change the address, bridge or cut E1 and E2.

E1	E2	A1	A0	7 Bits Slave Address
Short	Short	0	0	0x40(default)
Short	Open	0	1	0x41
Open	Short	1	0	0x44
Open	Open	1	1	0x45

For details on I<sup>2</sup>C addresses, refer to the I<sup>2</sup>C Slave Addresses table in the *ISL28022 Datasheet*.

## 2. Board Design

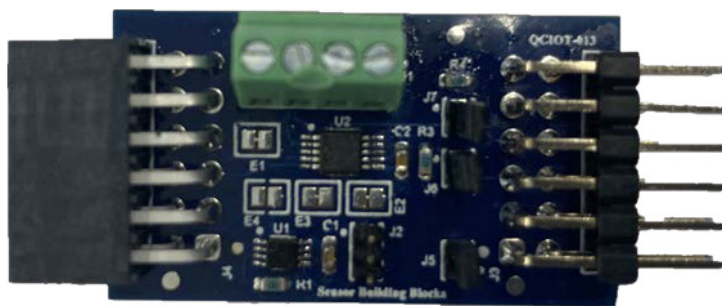

Figure 4. QC10T-013 Power Monitor Board Image (Top)

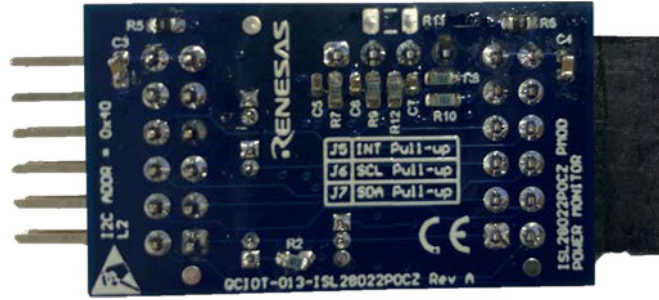

Figure 5. QC10T-013 Power Monitor Board Image (Bottom)

## 2.1 Schematic Diagrams

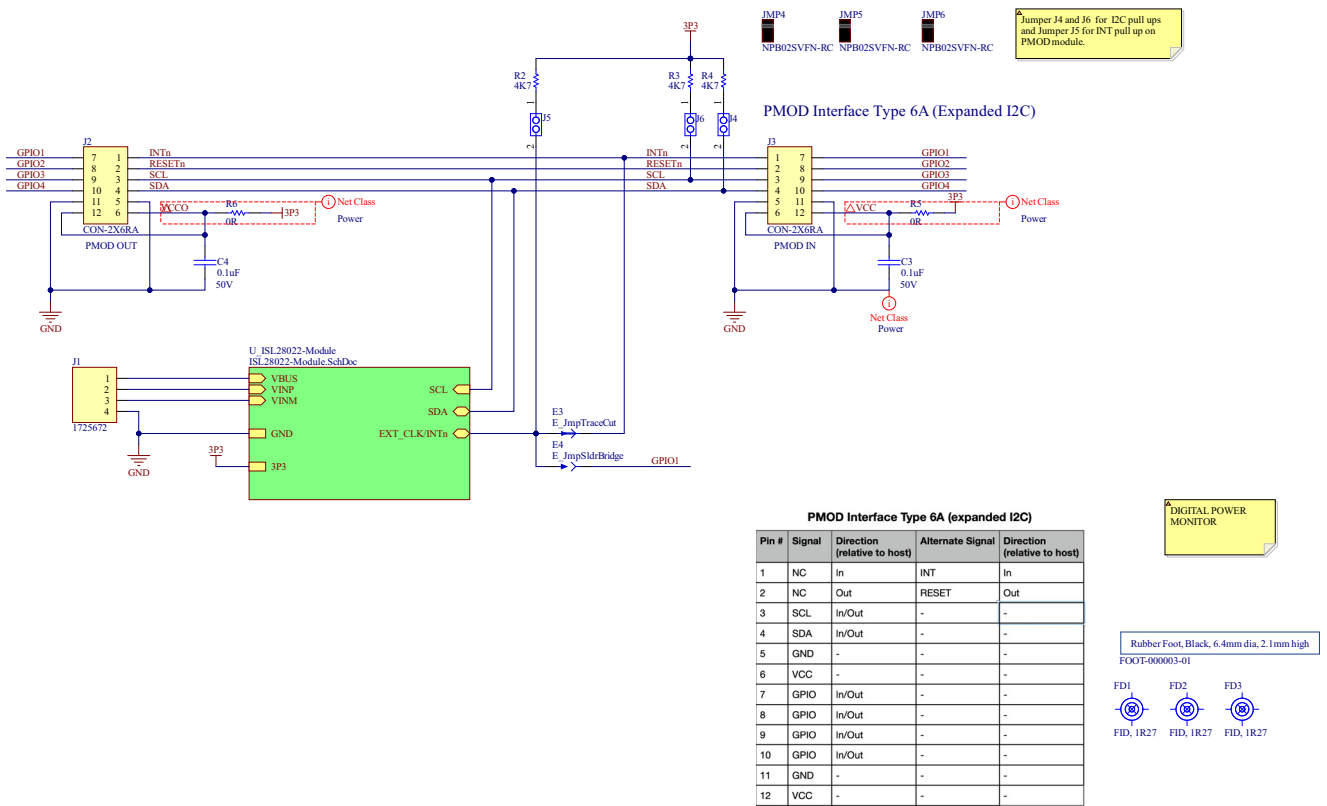

Figure 6. QC10T-013 Power Monitor Board Schematic



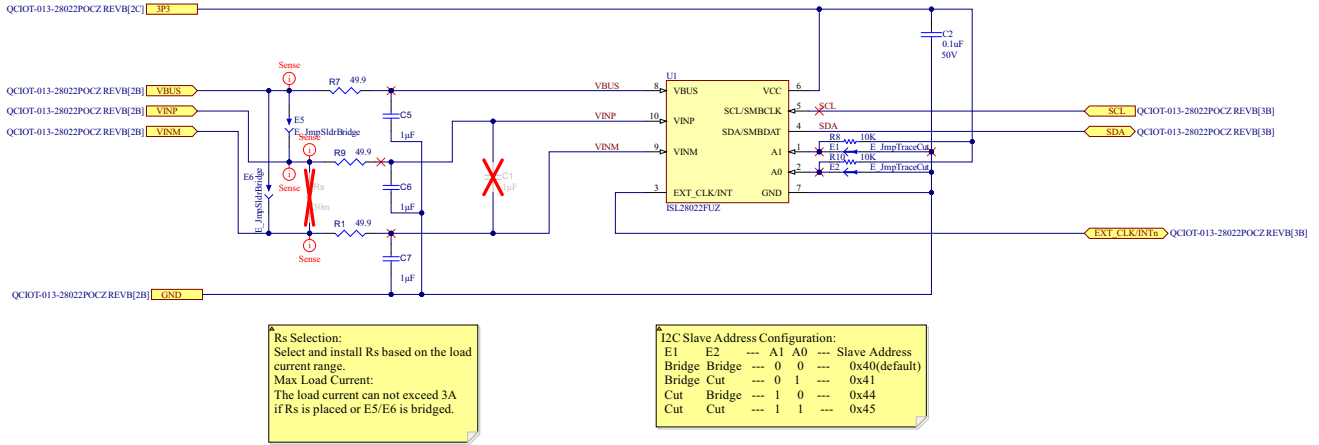

Figure 7. ISL28022 Digital Power Monitor Schematic

## 2.2 Bill of Materials

Qty	Reference Designator	Description	Manufacturer	Manufacturer Part Number
3	C2, C3, C4	Capacitor, 0.1 $\mu$ F, 50V, SM	Yageo	CC0603KRX7R9BB104
3	C5, C6, C7	Ceramic Capacitor, Multilayer, Ceramic, 100V, 10% +Tol, 10% -Tol, X7S, 22% TC, 1 $\mu$ F, Surface Mount, 0805	TDK	CGA4J3X7S2A105K125AE
1	FOOT1	Foot, Rubber, Self-adhesive, Black, 6.4mm dia, 2.1mm tall	Bumper Specialties	BS25BL07X30RP
1	J1	Connector, 1x4, 2.54mm, RA, Terminal Block, TH	Phoenix Contact	1725672
1	J2	Connector, 2x6, 0.1", PMOD, Socket, Right Angle	Samtec	SSW-106-02-F-D-RA
1	J3	Connector, 2x6, 0.1", PMOD, Header, Right Angle, Unshrouded	Harwin	M20-9950645
3	J4, J5, J6	Jumper, 1x2, 0.05" Pitch	Sullins	GRPB021VWVN-RC
3	JMP4, JMP5, JMP6	2 C, Closed Top, 050" CC; No Mounting, 105 C, Nylon 66; Phos Bronze, Gold Flash	Sullins	NPB02SVFN-RC
3	R1, R7, R9	Fixed Resistor, Metal Glaze/thick Film, 0.1W, 49.9 $\Omega$ , 75V, 1% +/-Tol, 100ppm/Cel, Surface Mount, 0603	Vishay Dale	CRCW060349R9FKEC
3	R2, R3, R4	Resistor, 4.7K $\Omega$ , 1/8W, 1%, SM	KOA Speer	RK73H1JTDD4701F
2	R5, R6	Resistor, 0 $\Omega$ , 1/8W, 1%, SM	KOA Speer	RK73Z1JTDD
2	R8, R10	Resistor, 10K $\Omega$ , 1/8W, 1%, SM	KOA Speer	RK73H1JTDD1002F
1	U1	Power Monitor, 16-bit Sigma-Delta ADC, I <sup>2</sup> C/SMBus Interface, SM	Renesas	ISL28022FUZ

## 2.3 Board Layout

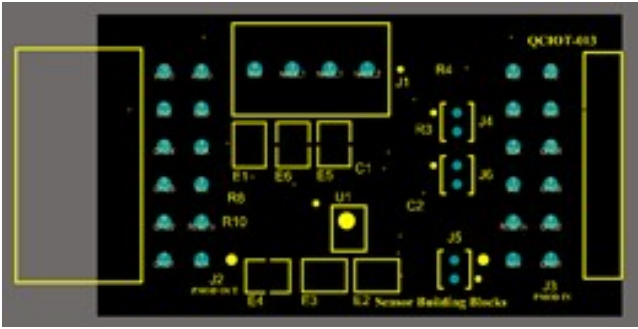

Figure 8. Top Overlay

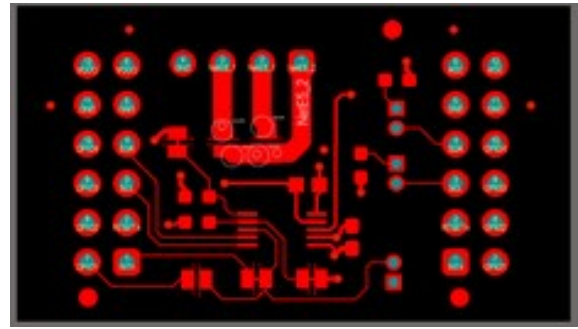

Figure 9. Top Layer

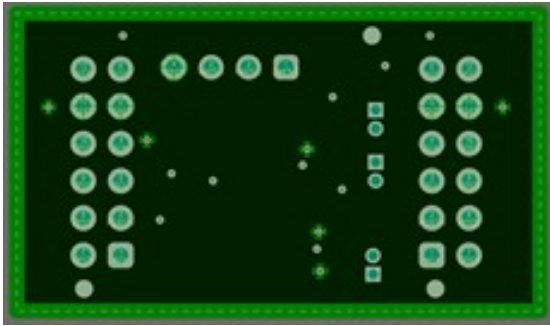

Figure 10. Layer 2 (GND)

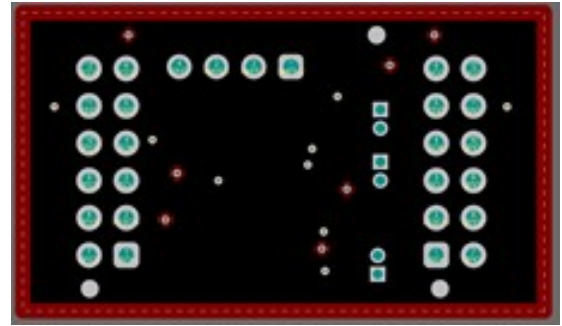

Figure 11. Layer 3 (Signal)

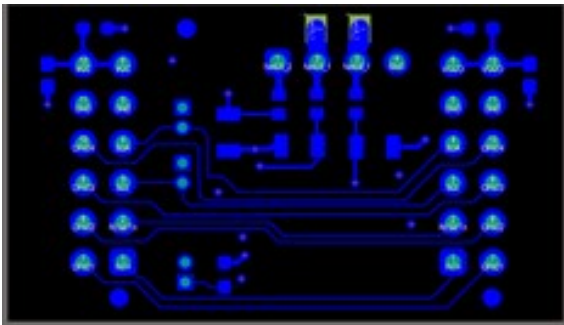

Figure 12. Bottom Layer

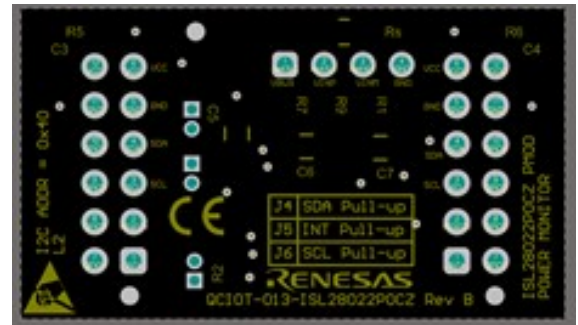

Figure 13. Bottom Overlay

### 3. Software Design

The following sections give an overview of the software implementation for the QCIOT-013 Digital Power Monitor Board, which is based on the Renesas RA Family's Flexible Software Package (FSP). These sections detail the project's code structure, the system's software modules, and the main system flow. The application-level code is based on FreeRTOS, which allows two threads to be implemented, the ISL28022 and BLE threads. The Bluetooth connection is available so that users can use the Renesas mobile application to connect, read, and control the DPM device.

#### 3.1 Project Code Structure

The Quick Connect DPM project is designed to be a highly modular solution that can be easily configured independently of other modules (if required) or ported to other end applications.

The project is split into two main parts:

- ISL28022 driver – Device driver code for power monitoring that includes the I<sup>2</sup>C communications driver.
- Application code – Main system code that enables the driver code and implements system flow.

The driver module contains the C source files and header files. The specific user configurations is included in the application code. Refer to the [User Settings](#) section for details regarding user configurations.

Figure 14 shows the structure of the project in e<sup>2</sup> studio.

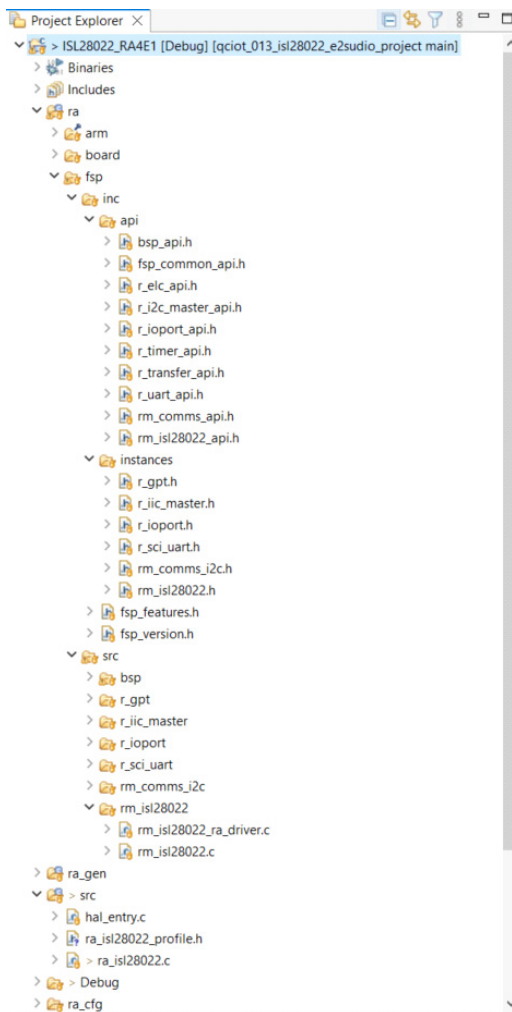

ra – Automatically generated files for FSP drivers, ISL28022 driver source code, and header file.

- rm\_isl28022.h – ISL28022 driver header file
- rm\_isl28022.c – ISL28022 driver source file
- rm\_isl28022\_api.h – ISL28022 API header file
- rm\_isl28022\_ra\_driver.c – Software delay function

ra\_gen – Generated files by FSP configuration

src – Application code that use is28022 driver.

- ra\_isl28022.c - Digital power monitor source file
- ha\_entry.c - Start of code execution, which calls system main

Figure 14. ISL28022 Project Structure

- `qe_gen/ble` – Automatically generated files from QE for BLE tool.
- `ra/fsp` – Automatically generated files for FSP drivers and isl28022 driver source code and header file.
  - `inc/api/r_ble_api.h` – Automatically generated file, Bluetooth API header file
  - `inc/api/r_ble_abs_api.h` – Automatically generated file, Bluetooth API header file
  - `inc/instances/r_ble_abs.h` – Automatically generated file, Bluetooth header file
  - `inc/api/rm_isl28022_api.h` – ISL28022 API header file
  - `inc/instances/rm_isl28022.h` – ISL28022 driver header file
  - `src/rm_ble_abs_gtl` – BLE lower layer drivers
  - `src/rm_isl28022/rm_isl28022.c` – ISL28022 driver source file
  - `src/rm_isl28022/rm_isl28022_ra_driver.c` – Software delay function
- `ra/renesas/wireless/da14xxx` – Automatically generated files for BLE drivers
- `ra_gen` – Generated files by FSP configuration
- `src` – Application code that uses ISL28022 driver
  - `isl28022_thread_entry.c` – ISL28022 application file
  - `ra_isl28022_profile.h` – User setting file
  - `ble_thread_entry.c` – Bluetooth application code
  - `gui_config.json` – Jason file that defines the GUI layout of the mobile application

When you click **configuration.xml** in the project and select the **Stack** tab, a stack configuration appears (Figure 15).

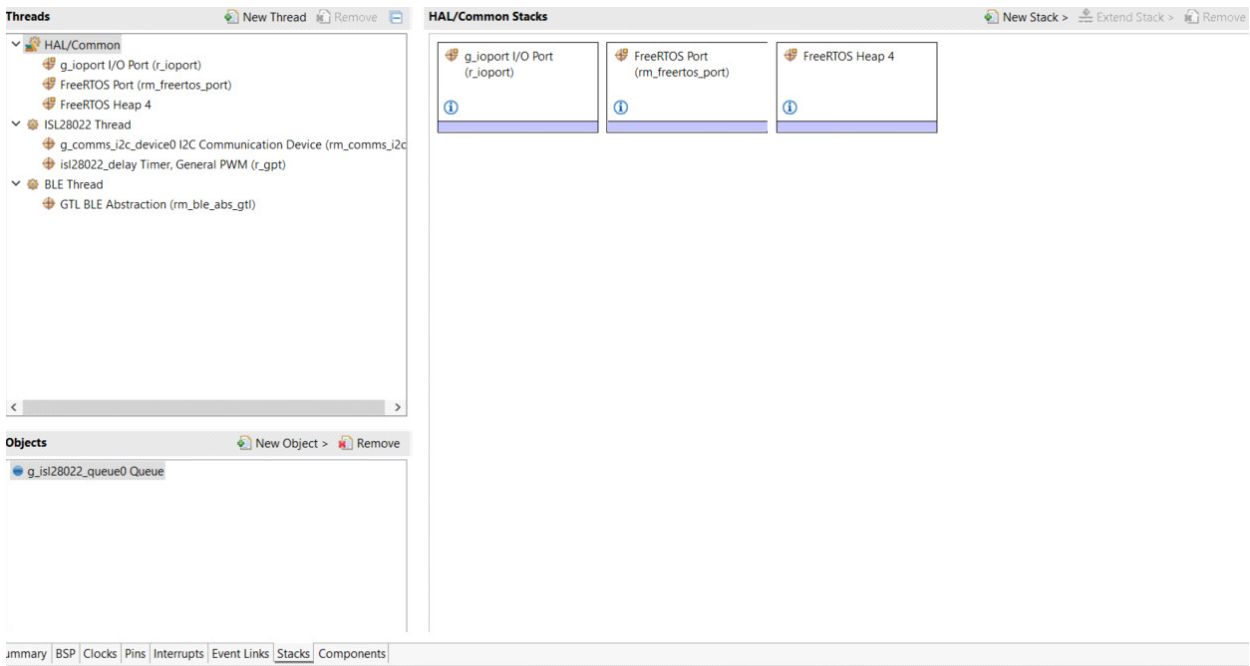

Figure 15. Stack Configuration – Hal/Common

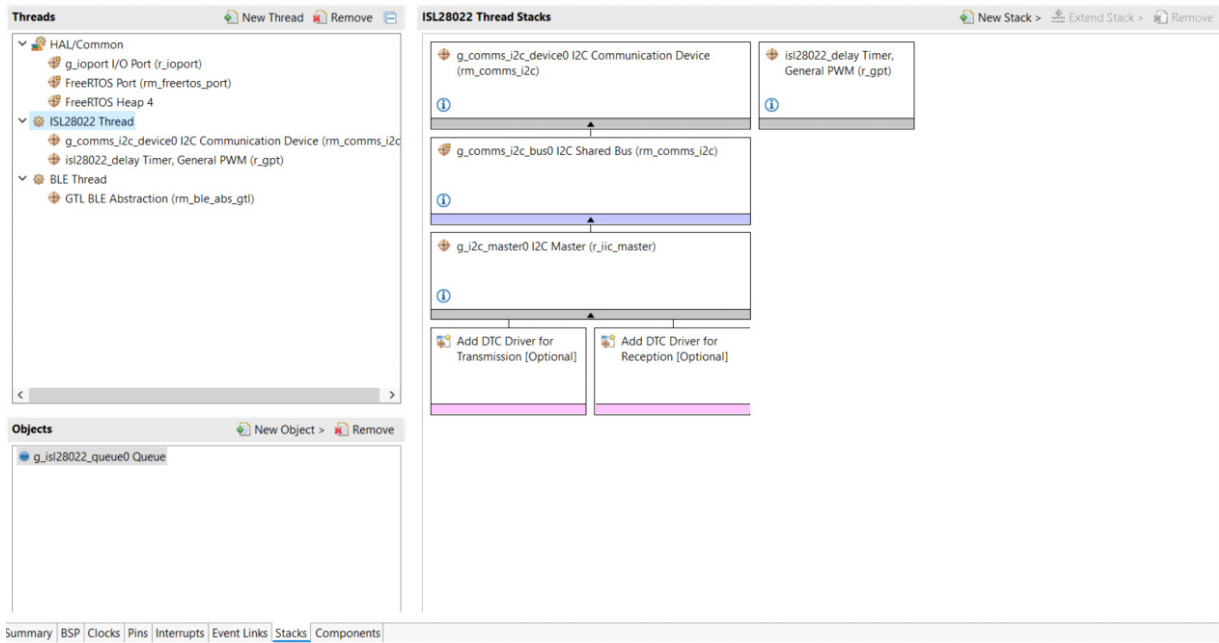

Figure 16. Stack Configuration – ISL28022 Thread Stacks

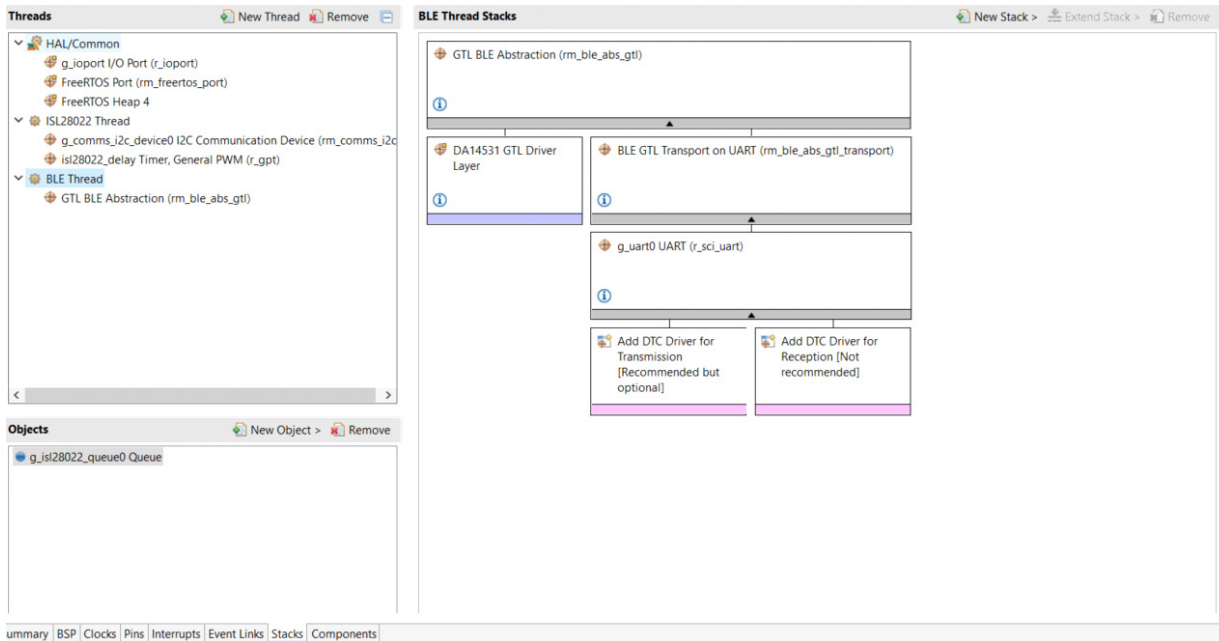

Figure 17. Stack Configuration – BLE Thread Stacks

Figure 18 shows the general code structure in terms of its dependencies. Execution begins in the main function (main.c) initiating an application flow that creates and starts two threads. The ISL28022 DPM driver module is called in isl28022\_thread, and the Bluetooth communication is handled in ble\_thread. All associated header files reference the lower-level Flexible Software Package (FSP) drivers.

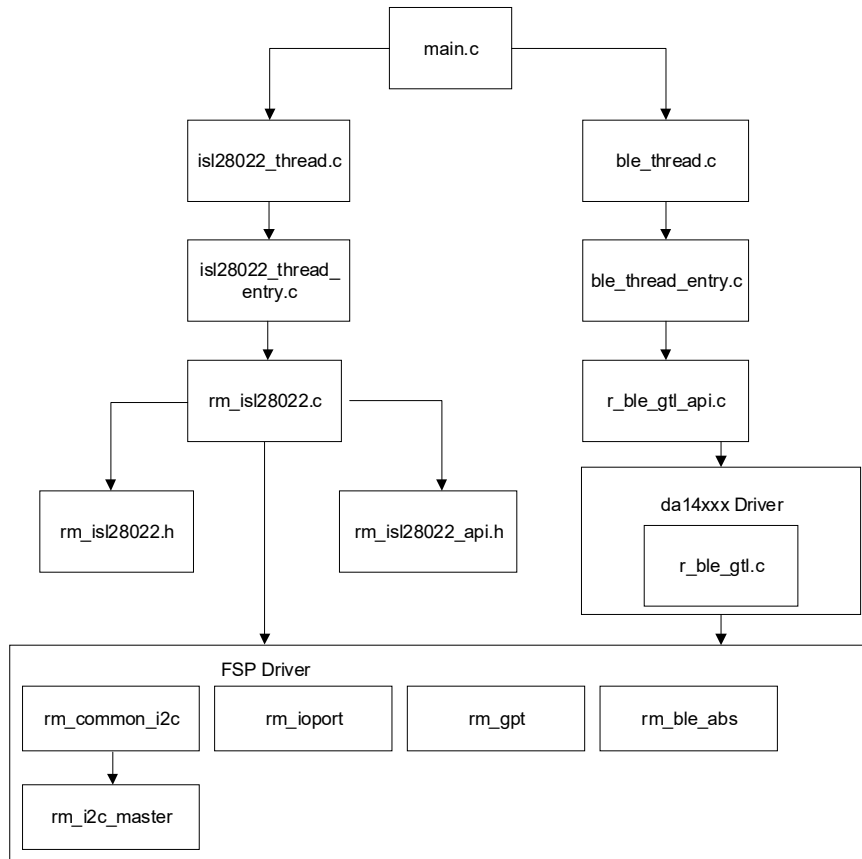

Figure 18. Code Dependency Graph

### 3.2 Software Module Overview

With a focus on the ISL28088 thread that contains the main system algorithm and is described in the main system flow, this module is responsible for initializing and setting up the driver that is used in the main algorithm. Also, this module makes calls to the other modules to initialize and setup. After initialization, this module is responsible for monitoring the system, displaying faults (if any), and shutting down the system in the event of faults. This module also keeps a continuous check of the I<sup>2</sup>C connection. The algorithm is responsible for initializing and setting up DPM module.

#### 3.2.1 ISL28022 Thread

The ISL28022 driver is a device driver that can monitor the current and voltage in the system for added protection. This module is responsible for initializing the FSP I2C driver and setting up the DPM device with the user-configured settings.

After setup, the module provides the following features:

- Performing various device commands (software reset and others)
- Reading the bus voltage and shunt voltage
- Reading the current and power and auxiliary side voltage
- Detect device faults (overvoltage, undervoltage, and others)
- Reading from and writing to all device registers
- Calibrate the module.
- Enable and disable the interrupt pin.

### 3.2.2 Algorithm Flowchart

Figure 19 describes the algorithm at a high level.

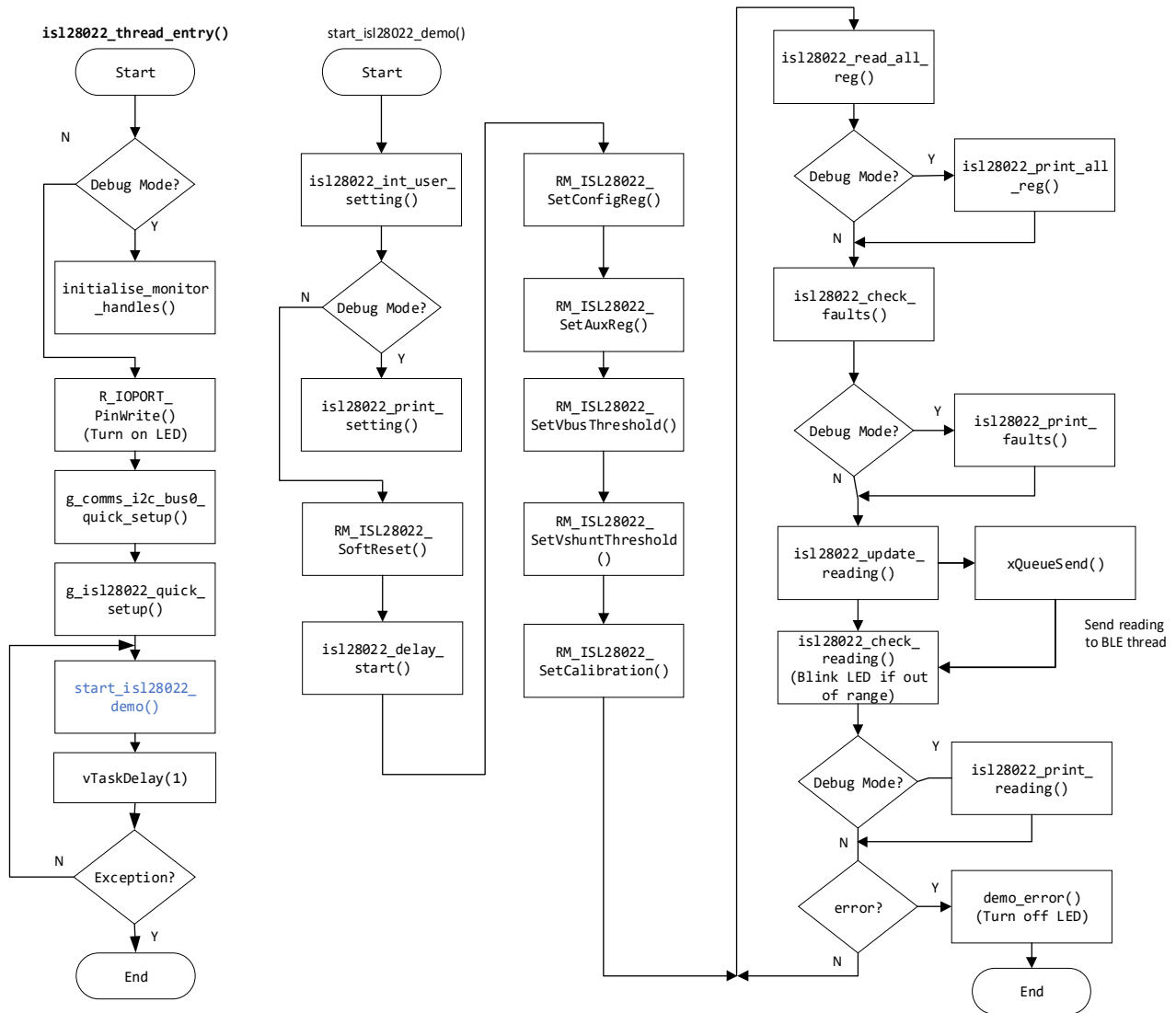

Figure 19. Algorithm Flowchart

The I<sup>2</sup>C bus is opened by g\_comms\_i2c\_bus0\_quick\_setup(). Then, the ISL28022 instance is opened by g\_isl28022\_quick\_setup(). If the device is opened successfully, LED1 and LED2 turn on.

The user setting should be initialized by user first. ISL28022 is configured by RM\_ISL28022\_SetConfigReg(), RM\_ISL28022\_SetAuxReg(), RM\_ISL28022\_SetVbusThreshold() and RM\_ISL28022\_SetVshuntThreshold().

The main program loops continuously to get the DPM readings by isl28022\_update\_reading() function calls. The Vbus, Vshunt, Current, and power are displayed in the Renesas Debug Virtual Console if in debug mode.

The loop checks the fault status by using isl28022\_check\_faults(). If any faults such as bus voltage overvoltage, bus voltage undervoltage (or other) occur, the faults are displayed in the Renesas Debug Virtual Console if in debug mode causing LED2 to turn off.

The loop checks the reading by using isl28022\_check\_reading(). LED2 will be blinking if the Vbus voltage and Current are out of the range of the user setting (see [User Settings](#)).

The functions outlined in [Figure 19](#) are described as follows:



### isl28022\_thread\_entry ()

- Call initialise\_monitor\_handles() function
- Call g\_comms\_i2c\_bus0\_quick\_setup()
- Call g\_isl28022\_quick\_setup()
- initialise\_monitor\_handles ()
  - This function must be called at the beginning of the code to enable the debug console.
  - Call this function if only in debug mode.
- g\_comms\_i2c\_bus0\_quick\_setup()
  - Open I2C driver, this must be done before calling any COMMS API.
- g\_isl28022\_quick\_setup()
  - Open ISL28022 dpm instance, this must be done before calling any ISL28022 API.
  - Open timer instance.

### start\_isl28022\_demo ()

- Call isl28022\_init\_user\_setting()
- Call isl28022\_print\_setting()
- Call isl28022\_read\_all\_reg()
- Call isl28022\_print\_all\_reg()
- Call isl28022\_check\_faults()
- Call isl28022\_print\_faults()
- Call isl28022\_update\_reading()
- Call isl28022\_check\_reading()
- Call isl28022\_print\_reading()
- Call RM\_ISL28022\_SoftReset()
- Call isl28022\_delay\_start()
- Call RM\_ISL28022\_SetConfigReg()
- Call RM\_ISL28022\_SetAuxReg()
- Call RM\_ISL28022\_SetVbusThreshold()
- Call RM\_ISL28022\_SetVshuntThreshold()
- Call RM\_ISL28022\_SetCalibration()
- Call demo\_err()
- isl28022\_init\_user\_setting()
  - Initialize the global user setting with the default value
  - The user settings are mode, shunt resistor value, bus voltage full scale, shunt volage full scale, bus ADC resolution, shunt ADC resolution, bus volage max threshold, bus volage min threshold, shunt voltage max threshold, shunt volage min threshold, interrupt pint configuration, external clock configuration.
- isl28022\_print\_setting()
  - Continuously check for IIC connection Print the setting to Renesas Debug Virtual Console.
- isl28022\_read\_all\_reg()
  - Read all register of ISL28022.
- isl28022\_print\_all\_reg ()
  - Print the value of all register of ISL28022 to Renesas Debug Virtual Console.

- `isl28022_check_faults()`
  - Check the faults status of ISL28022.
- `isl28022_print_faults()`
  - Print the faults status of ISL28022 to Renesas Debug Virtual Console.
- `isl28022_update_reading()`
  - Read Vbus, Vshunt, Current and Power etc.
- `isl28022_check_reading ()`
  - Check if the reading of Vbus, Vshunt, Current and Power is within the range that user set up. If not, blink the LED2.
- `isl28022_print_reading ()`
  - Print the Vbus, Vshunt, Current and Power of ISL28022 to Renesas Debug Virtual Console.
- `isl28022_delay_start()`
  - Start the software delay.
- `RM_ISL28022_SoftReset ()`
  - Soft reset the ISL28022 by configuring the Bit15 of Configuration register.
- `RM_ISL28022_SetConfigReg()`
  - Write CONFIGURATION register of ISL28022 with the user setting.
- `RM_ISL28022_SetAuxReg()`
  - Write AUX register of ISL28022 with the user setting.
- `RM_ISL28022_SetVbusThreshold()`
  - Set the threshold of Vbus of ISL28022 by writing the BUS VOLTAGE THRESHOLD register
- `RM_ISL28022_SetVshuntThreshold()`
  - Set the threshold of the shunt voltage of ISL28022 by writing the SHUNT VOLTAGE THRESHOLD register
- `RM_ISL28022_SetCalibration()`
  - Calibrate ISL28022.
  - Must be done before reading Current and Power.

### 3.2.3 Hierarchy Chart

Figure 20 outlines the hierarchy of function calls.

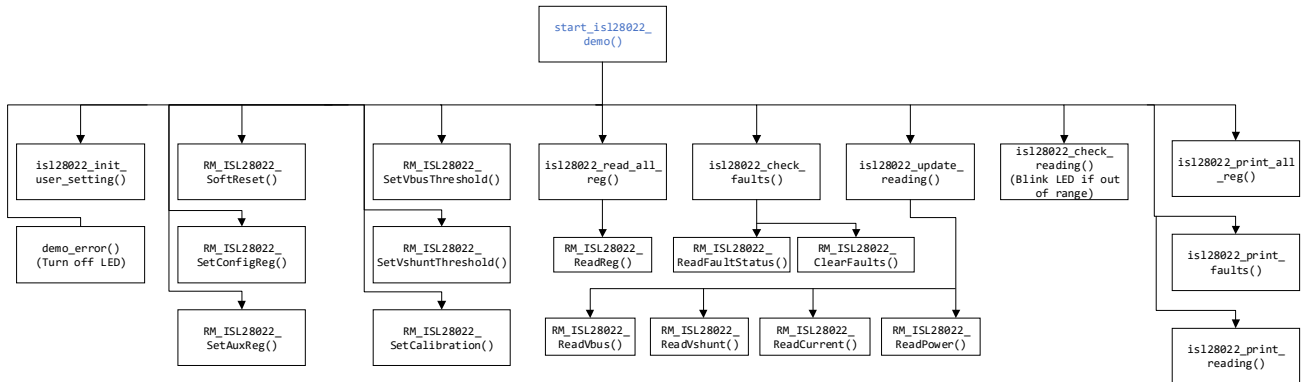

Figure 20. Function Call Hierarchy

## 3.3 User Settings

### 3.3.1 Configure DPM

This section outlines all the configurable user settings in the demo project. Configurable settings are mainly included in the profile header for the DPM. These configurations are defined macros with the `_USER` suffix. The list of user configurable settings for the DPM device is not exhaustive; the most used settings are included in the Profile headers, but all register settings in the DPM setup functions can also be adjusted directly. Refer to the datasheet for guidance on register settings and values.

*Note:* The user will require an E2 emulator to make changes to the project.

```

main.c x ra_isl28022_profi... x ra_isl28022.c rm_isl28022.c rm_isl28022_api.h rm_isl28022_ra_d... hal_entry.c rm_isl28022.h
1
2
3
4
5
6
7
8
9
10
11
12
13
14
15
16
17
18
19
20
21
22
23
24
25
26
27
28
29
30
31
32
/* Includes
*****
#include "rm_isl28022_api.h"

* Macro definitions
|
#define ISL28022_RSHUNT_OHM_USER (25.0f)
// #define ISL28022_RSHUNT_OHM_USER (0.05f)
#define ISL28022_VSHUNT_MAX_THRESHOLD_V_USER (0.32f)
#define ISL28022_VSHUNT_MIN_THRESHOLD_V_USER (-0.32f)
#define ISL28022_VBUS_MAX_THRESHOLD_V_USER (60.0f)
#define ISL28022_VBUS_MIN_THRESHOLD_V_USER (0.0f)
#define ISL28022_CONFIG_MODE_USER RM_ISL28022_MODE_SHUNTANDBUS_CONTINUOUS
#define ISL28022_VBUS_FULL_SCALE_USER RM_ISL28022_VBUS_FULLSCALE_60V
#define ISL28022_VSHUNT_FULL_SCALE_USER RM_ISL28022_VSHUNT_FULLSCALE_320MV
#define ISL28022_AUX_INT_PIN_EN_USER RM_ISL28022_AUXCONTROL_INTERRUPT_PIN_DISABLE
#define ISL28022_AUX_INT_PIN_FORCE_USER RM_ISL28022_AUXCONTROL_INTERRUPT_PIN_FORCE_NOACTIVE
#define ISL28022_AUX_EXTCLK_EN_USER RM_ISL28022_AUXCONTROL_EXTCLK_DISABLE
#define ISL28022_AUX_EXTCLK_DIV_USER RM_ISL28022_AUXCONTROL_EXTCLK_DIV0

#define BOARDTEST_VBUS_TARGET_V_USER (3.3f)
#define BOARDTEST_VBUS_TOLERANCE_PERCENT_USER (0.05f)
#define BOARDTEST_LOAD_RESISTOR_OHM_USER (5000)
#define BOARDTEST_CURRENT_TOLERANCE_PERCENT_USER (0.1f)
  
```

Figure 21. Profile Header Files

The user settings and their usage are outlined in the [Table 1](#). The user can adjust these values to fit the end application. *Note:* Some register settings adhere to multiple settings, and those settings are not fully listed. Refer to the datasheet for more information.

**Table 1. User Settings**

Name	Usage	Default Value
ISL28022_RSHUNT_OHM_USER <sup>[1]</sup>	Shunt resistance value in $\Omega$ s	25
ISL28022_VSHUNT_MAX_THRESHOLD_V_USER	Overvoltage threshold of shunt voltage in volt	0.32
ISL28022_VSHUNT_MIN_THRESHOLD_V_USER	Undervoltage threshold of shunt voltage in volt	-0.32
ISL28022_VBUS_MAX_THRESHOLD_V_USER	Overvoltage threshold of bus voltage in volt	60
ISL28022_VBUS_MIN_THRESHOLD_V_USER	Undervoltage threshold of bus voltage in volt	0
ISL28022_CONFIG_MODE_USER	Select Shunt voltage and/or bus voltage for ADC; set up the power mode and ADC mode	Shunt and bus voltage, continuous
ISL28022_VBUS_FULL_SCALE_USER	Bus voltage full scale	320mV
ISL28022_VSHUNT_FULL_SCALE_USER	Shunt voltage full-scale range	60V
ISL28022_AUX_INT_PIN_EN_USER	Enable or disable interrupt pin	Enable
ISL28022_AUX_INT_PIN_FORCE_USER	Force interrupt pin active or not	Non active
ISL28022_AUX_EXTCLK_EN_USER	Enable or disable external clock	Disable
ISL28022_AUX_EXTCLK_DIV_USER	External clock divider	No divider

1. The ISL28022\_RSHUNT\_OHM\_USER value should match your chosen shunt resistor.

## 3.4 Board Test

### 3.4.1 Set Up the Boards and Cable

Verify that you have followed the procedure in [Setup and Configuration](#).

### 3.4.2 Program the Development Board and Run Example Code in Debug Mode

1. Open the sample project in e2studio.

2. From the menu bar, select **Run > Debug Configuration**.

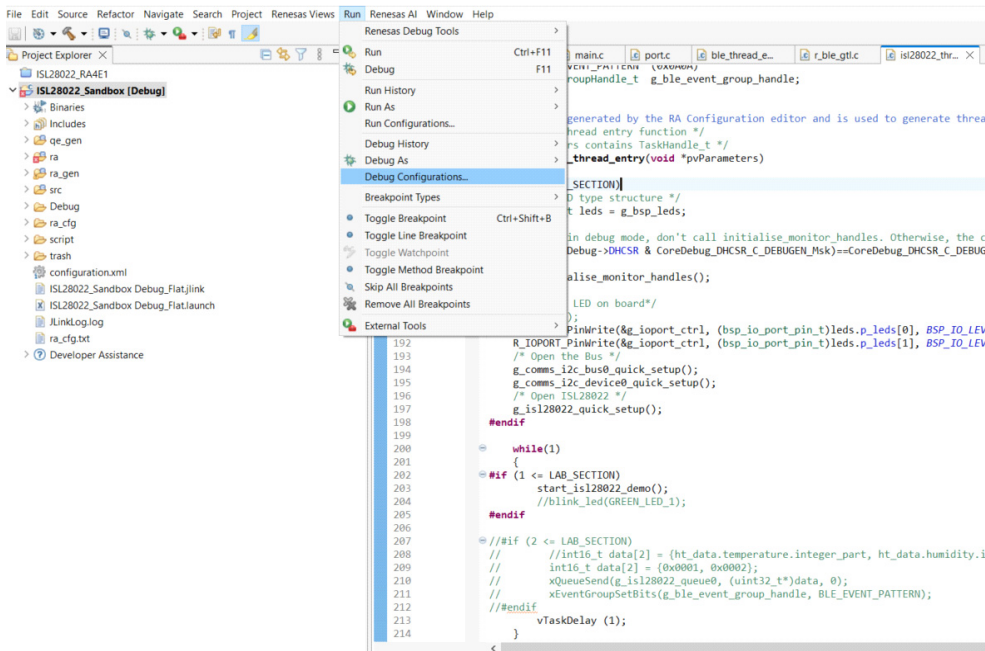

Figure 22. Debug Configuration

3. In **Renesas GDB Hardware Debugging**, select **isl28022\_Sandbox\_Debug**.

4. Click the **Debug** button. The code enters debug mode (see Figure 24).

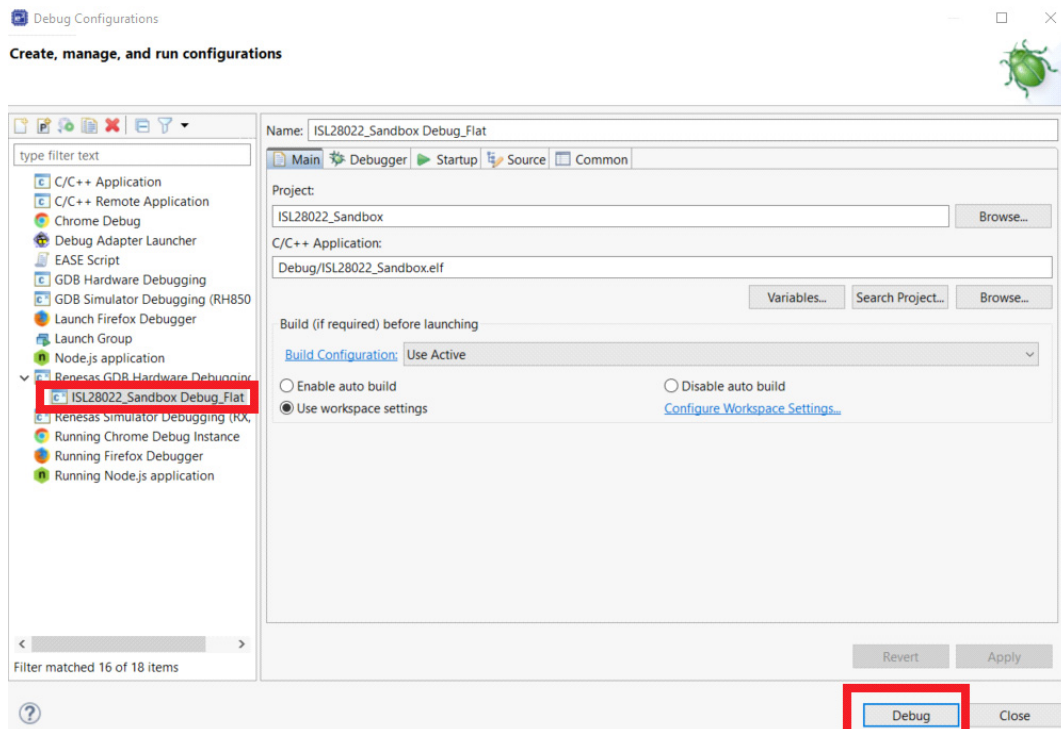

Figure 23. Starting Debug Mode

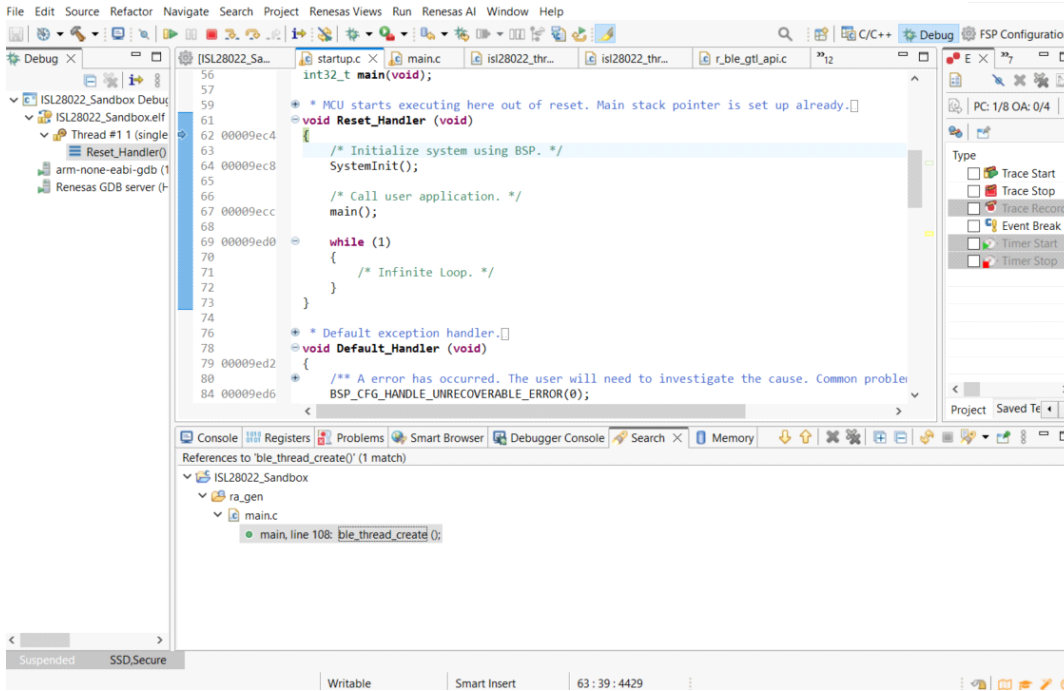

Figure 24. Entering Debug Mode

5. From the menu bar, select **Renesas Views > Debug > Renesas Debug Virtual Console**.

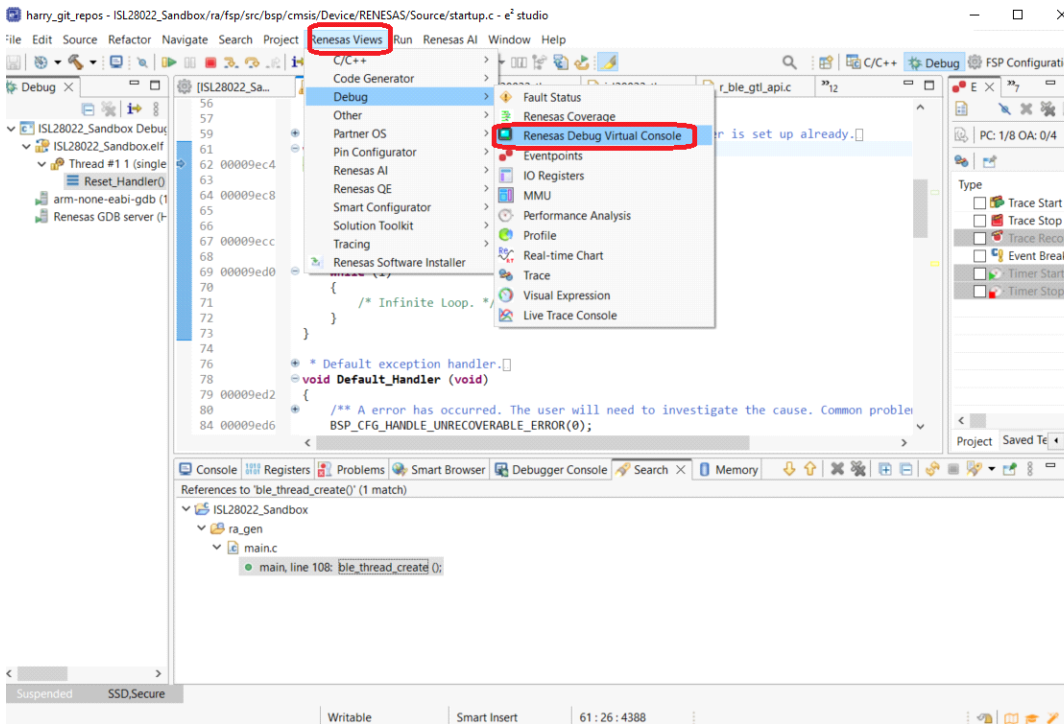

Figure 25. Opening the Virtual Console

a. The Renesas Debug Virtual Console appears.

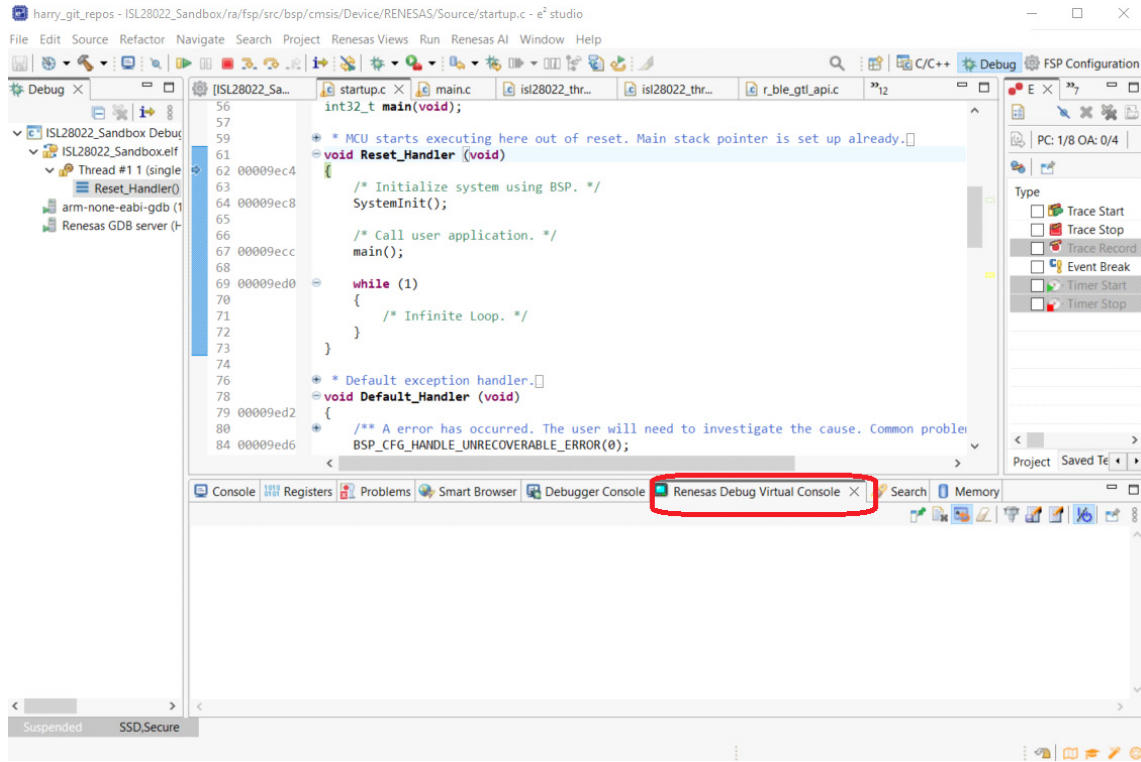

Figure 26. Renesas Debug Virtual Console

6. When you click , the debug information appears in the Renesas Debug Virtual Console window.

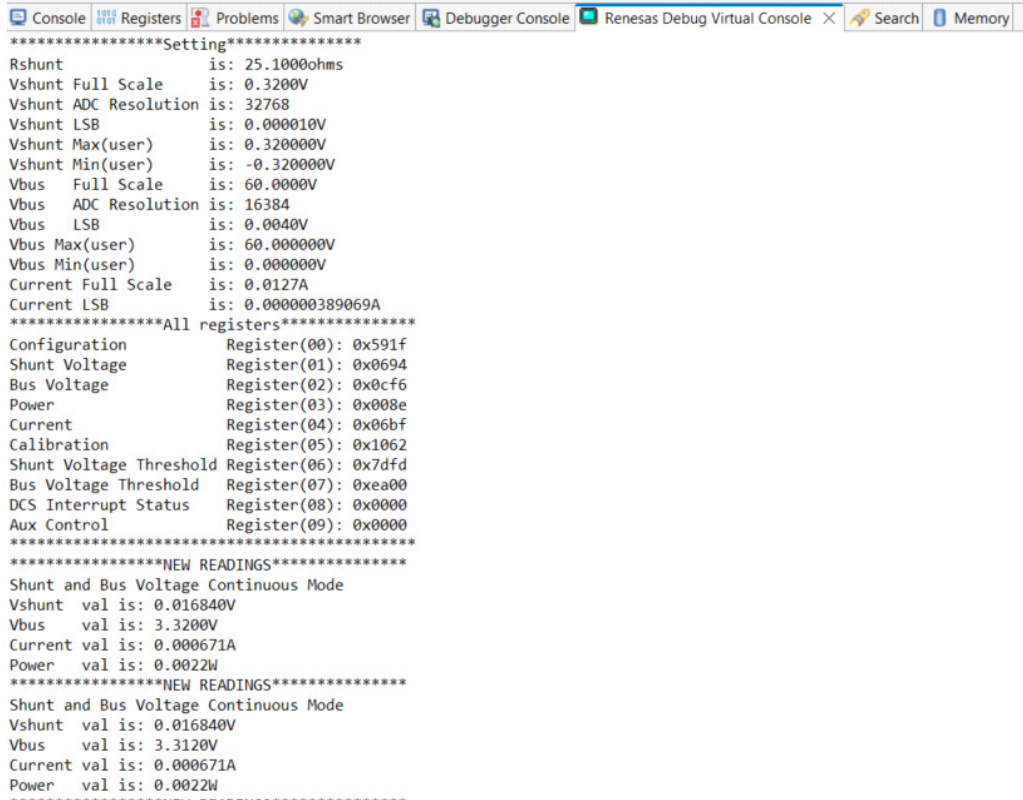

Figure 27. Debug Information

### 3.4.3 Quick-Connect Sandbox Application

When you program the FPB board, you can read the  $V_{BUS}$  voltage and current on a smart device with the BLE connection.

The following hardware is required.

- Renesas Bluetooth Pmod Board, US159-DA14531EVZ (sold separately)
  - iOS or Android smart device (such as a smartphone or tablet)
1. Plug in the Bluetooth Pmod Board, US159-DA14531EVZ, to the PMOD2 connector of FPB-RA4E1.

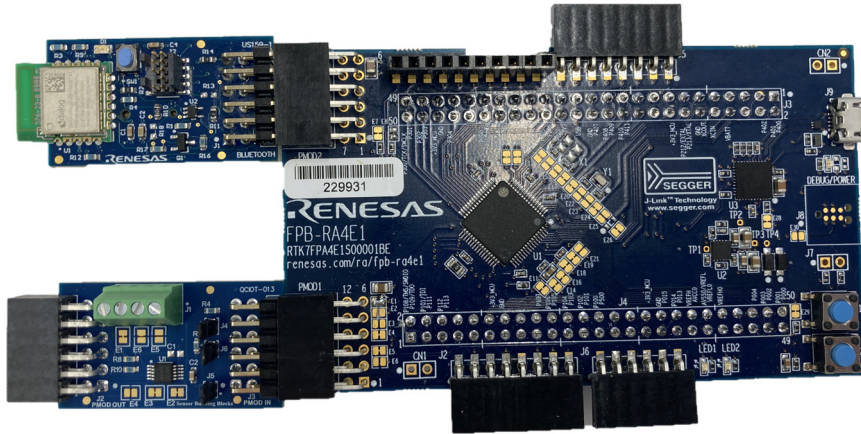

Figure 28. QCIOT-013 Power Monitor Board with FPB-RA4E1 MCU Kit

2. Install the Renesas Quick-Connect Mobile Sandbox Application (version 1.2.0 or later) on a smart device.
  - a. Download the app from either the Play Store (Android) or App Store (iOS). Search for QC Sandbox or use the following barcodes:



Android



iOS

Figure 29. QR Codes for Android and iOS

3. Start the application. A scan automatically begins for Bluetooth LE devices.
4. Scroll the list to find and select your device.



- 5. Click the **Connect** button.

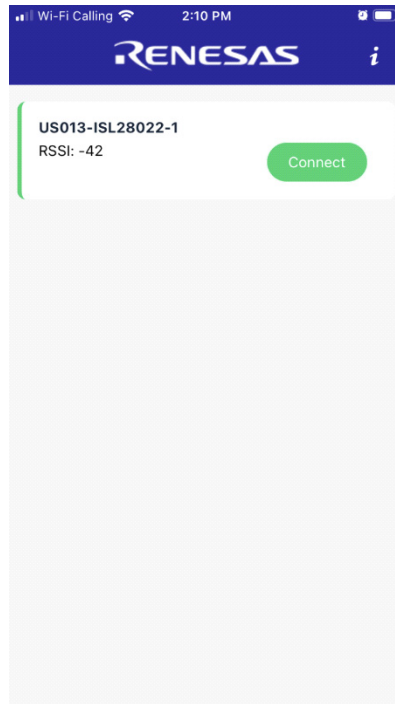

Figure 30. Quick-Connect Sandbox GUI

- a. Measurements appear for BusVoltage and Current(A).



Figure 31. Bus Voltage and Current Reading

- b. If Current(A) does not appear, go to the setting by pressing the list icon, and check BusVoltage and Current.

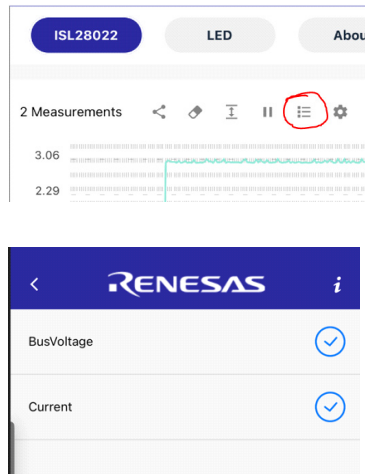

Figure 32. Enabling BusVoltage and Current Display

## 4. Ordering Information

Part Number	Description
QCIOT-013-28022POCZ	QCIOT Digital Power Monitor Pmod Board

## 5. Revision History

Revision	Date	Description
1.01	Mar 25, 2024	Updated Page 1. Updated section 1.2 Setup and Configuration. Added section 3.4 Board Test.
1.00	Dec 15, 2023	Initial release

## IMPORTANT NOTICE AND DISCLAIMER

RENESAS ELECTRONICS CORPORATION AND ITS SUBSIDIARIES (“RENESAS”) PROVIDES TECHNICAL SPECIFICATIONS AND RELIABILITY DATA (INCLUDING DATASHEETS), DESIGN RESOURCES (INCLUDING REFERENCE DESIGNS), APPLICATION OR OTHER DESIGN ADVICE, WEB TOOLS, SAFETY INFORMATION, AND OTHER RESOURCES “AS IS” AND WITH ALL FAULTS, AND DISCLAIMS ALL WARRANTIES, EXPRESS OR IMPLIED, INCLUDING, WITHOUT LIMITATION, ANY IMPLIED WARRANTIES OF MERCHANTABILITY, FITNESS FOR A PARTICULAR PURPOSE, OR NON-INFRINGEMENT OF THIRD-PARTY INTELLECTUAL PROPERTY RIGHTS.

These resources are intended for developers who are designing with Renesas products. You are solely responsible for (1) selecting the appropriate products for your application, (2) designing, validating, and testing your application, and (3) ensuring your application meets applicable standards, and any other safety, security, or other requirements. These resources are subject to change without notice. Renesas grants you permission to use these resources only to develop an application that uses Renesas products. Other reproduction or use of these resources is strictly prohibited. No license is granted to any other Renesas intellectual property or to any third-party intellectual property. Renesas disclaims responsibility for, and you will fully indemnify Renesas and its representatives against, any claims, damages, costs, losses, or liabilities arising from your use of these resources. Renesas' products are provided only subject to Renesas' Terms and Conditions of Sale or other applicable terms agreed to in writing. No use of any Renesas resources expands or otherwise alters any applicable warranties or warranty disclaimers for these products.

(Disclaimer Rev.1.01 Jan 2024)

### Corporate Headquarters

TOYOSU FORESIA, 3-2-24 Toyosu,  
Koto-ku, Tokyo 135-0061, Japan  
[www.renesas.com](http://www.renesas.com)

### Trademarks

Renesas and the Renesas logo are trademarks of Renesas Electronics Corporation. All trademarks and registered trademarks are the property of their respective owners.

### Contact Information

For further information on a product, technology, the most up-to-date version of a document, or your nearest sales office, please visit [www.renesas.com/contact-us/](http://www.renesas.com/contact-us/).