

RH850 Evaluation Platform

# RH850/F1KM-S4 272pin RH850/F1KH-D8 272pin PiggyBack board

Y-RH850-F1X-272PIN-PB-T2-V1

All information contained in these materials, including products and product specifications, represents information on the product at the time of publication and is subject to change by Renesas Electronics Corp. without notice. Please review the latest information published by Renesas Electronics Corp. through various means, including the Renesas Technology Corp. website (<http://www.renesas.com>).

The newest version of this document can be obtained from the following web location  
<http://www.renesas.eu/updates?oc=Y-RH850-F1X-272PIN-PB-T2-V1>

## Notice

1. Descriptions of circuits, software and other related information in this document are provided only to illustrate the operation of semiconductor products and application examples. You are fully responsible for the incorporation or any other use of the circuits, software, and information in the design of your product or system. Renesas Electronics disclaims any and all liability for any losses and damages incurred by you or third parties arising from the use of these circuits, software, or information.
  2. Renesas Electronics hereby expressly disclaims any warranties against and liability for infringement or any other disputes involving patents, copyrights, or other intellectual property rights of third parties, by or arising from the use of Renesas Electronics products or technical information described in this document, including but not limited to, the product data, drawing, chart, program, algorithm, application examples.
  3. No license, express, implied or otherwise, is granted hereby under any patents, copyrights or other intellectual property rights of Renesas Electronics or others.
  4. You shall not alter, modify, copy, or otherwise misappropriate any Renesas Electronics product, whether in whole or in part. Renesas Electronics disclaims any and all liability for any losses or damages incurred by you or third parties arising from such alteration, modification, copy or otherwise misappropriation of Renesas Electronics products.
  5. Renesas Electronics products are classified according to the following two quality grades: "Standard" and "High Quality". The intended applications for each Renesas Electronics product depends on the product's quality grade, as indicated below.  
"Standard": Computers; office equipment; communications equipment; test and measurement equipment; audio and visual equipment; home electronic appliances; machine tools; personal electronic equipment; and industrial robots etc.  
"High Quality": Transportation equipment (automobiles, trains, ships, etc.); traffic control (traffic lights); large-scale communication equipment; key financial terminal systems; safety control equipment; etc.  
Renesas Electronics products are neither intended nor authorized for use in products or systems that may pose a direct threat to human life or bodily injury (artificial life support devices or systems, surgical implantations etc.), or may cause serious property damages (space and undersea repeaters; nuclear power control systems; aircraft control systems; key plant systems; military equipment; etc.). Renesas Electronics disclaims any and all liability for any damages or losses incurred by you or third parties arising from the use of any Renesas Electronics product for which the product is not intended by Renesas Electronics.
  6. When using the Renesas Electronics products, refer to the latest product information (data sheets, user's manuals, application notes, "General Notes for Handling and Using Semiconductor Devices" in the reliability handbook, etc.), and ensure that usage conditions are within the ranges specified by Renesas Electronics with respect to maximum ratings, operating power supply voltage range, heat radiation characteristics, installation, etc. Renesas Electronics disclaims any and all liability for any malfunctions or failure or accident arising out of the use of Renesas Electronics products beyond such specified ranges.
  7. Although Renesas Electronics endeavors to improve the quality and reliability of Renesas Electronics products, semiconductor products have specific characteristics such as the occurrence of failure at a certain rate and malfunctions under certain use conditions. Further, Renesas Electronics products are not subject to radiation resistance design. Please ensure to implement safety measures to guard them against the possibility of bodily injury, injury or damage caused by fire, and social damage in the event of failure or malfunction of Renesas Electronics products, such as safety design for hardware and software including but not limited to redundancy, fire control and malfunction prevention, appropriate treatment for aging degradation or any other appropriate measures by your own responsibility as warranty for your products/system. Because the evaluation of microcomputer software alone is very difficult and not practical, please evaluate the safety of the final products or systems manufactured by you.
  8. Please contact a Renesas Electronics sales office for details as to environmental matters such as the environmental compatibility of each Renesas Electronics product. Please investigate applicable laws and regulations that regulate the inclusion or use of controlled substances, including without limitation, the EU RoHS Directive carefully and sufficiently and use Renesas Electronics products in compliance with all these applicable laws and regulations. Renesas Electronics disclaims any and all liability for damages or losses occurring as a result of your noncompliance with applicable laws and regulations.
  9. Renesas Electronics products and technologies shall not be used for or incorporated into any products or systems whose manufacture, use, or sale is prohibited under any applicable domestic or foreign laws or regulations. You shall not use Renesas Electronics products or technologies for (1) any purpose relating to the development, design, manufacture, use, stockpiling, etc., of weapons of mass destruction, such as nuclear weapons, chemical weapons, or biological weapons, or missiles (including unmanned aerial vehicles (UAVs)) for delivering such weapons, (2) any purpose relating to the development, design, manufacture, or use of conventional weapons, or (3) any other purpose of disturbing international peace and security, and you shall not sell, export, lease, transfer, or release Renesas Electronics products or technologies to any third party whether directly or indirectly with knowledge or reason to know that the third party or any other party will engage in the activities described above. When exporting, selling, transferring, etc., Renesas Electronics products or technologies, you shall comply with any applicable export control laws and regulations promulgated and administered by the governments of the countries asserting jurisdiction over the parties or transactions.
  10. Please acknowledge and agree that you shall bear all the losses and damages which are incurred from the misuse or violation of the terms and conditions described in this document, including this notice, and hold Renesas Electronics harmless, if such misuse or violation results from your resale or making Renesas Electronics products available any third party.
  11. This document shall not be reprinted, reproduced or duplicated in any form, in whole or in part, without prior written consent of Renesas Electronics.
  12. Please contact a Renesas Electronics sales office if you have any questions regarding the information contained in this document or Renesas Electronics products.
- (Note 1) "Renesas Electronics" as used in this document means Renesas Electronics Corporation and also includes its majority-owned subsidiaries.
- (Note 2) "Renesas Electronics product(s)" means any product developed or manufactured by or for Renesas Electronics.

## General Precautions in the Handling of Microprocessing Unit and Microcontroller Unit Products

The following usage notes are applicable to all Microprocessing unit and Microcontroller unit products from Renesas. For detailed usage notes on the products covered by this document, refer to the relevant sections of the document as well as any technical updates that have been issued for the products.

### 1. Handling of Unused Pins

Handle unused pins in accordance with the directions given under Handling of Unused Pins in the manual.

- The input pins of CMOS products are generally in the high-impedance state. In operation with an unused pin in the open-circuit state, extra electromagnetic noise is induced in the vicinity of LSI, an associated shoot-through current flows internally, and malfunctions occur due to the false recognition of the pin state as an input signal become possible. Unused pins should be handled as described under Handling of Unused Pins in the manual.

### 2. Processing at Power-on

The state of the product is undefined at the moment when power is supplied.

- The states of internal circuits in the LSI are indeterminate and the states of register settings and pins are undefined at the moment when power is supplied.

In a finished product where the reset signal is applied to the external reset pin, the states of pins are not guaranteed from the moment when power is supplied until the reset process is completed. In a similar way, the states of pins in a product that is reset by an on-chip power-on reset function are not guaranteed from the moment when power is supplied until the power reaches the level at which resetting has been specified.

### 3. Prohibition of Access to Reserved Addresses

Access to reserved addresses is prohibited.

- The reserved addresses are provided for the possible future expansion of functions. Do not access these addresses; the correct operation of LSI is not guaranteed if they are accessed.

### 4. Clock Signals

After applying a reset, only release the reset line after the operating clock signal has become stable. When switching the clock signal during program execution, wait until the target clock signal has stabilized.

- When the clock signal is generated with an external resonator (or from an external oscillator) during a reset, ensure that the reset line is only released after full stabilization of the clock signal. Moreover, when switching to a clock signal produced with an external resonator (or by an external oscillator) while program execution is in progress, wait until the target clock signal is stable.

### 5. Differences between Products

Before changing from one product to another, i.e. to a product with a different part number, confirm that the change will not lead to problems.

- The characteristics of Microprocessing unit or Microcontroller unit products in the same group but having a different part number may differ in terms of the internal memory capacity, layout pattern, and other factors, which can affect the ranges of electrical characteristics, such as characteristic values, operating margins, immunity to noise, and amount of radiated noise. When changing to a product with a different part number, implement a system-evaluation test for the given product.

## Table of Contents

<b>Chapter 1</b>	<b>Introduction .....</b>	<b>5</b>
<b>Chapter 2</b>	<b>Overview .....</b>	<b>6</b>
2.1	Overview .....	6
2.2	Mounting of the device .....	7
2.3	Jumper configuration.....	7
<b>Chapter 3</b>	<b>Power supply .....</b>	<b>9</b>
3.1	Board power connection .....	9
3.2	Voltage distribution.....	10
<b>Chapter 4</b>	<b>Clock sources.....</b>	<b>11</b>
4.1.1	MainOsc.....	11
4.1.2	SubOSC .....	11
<b>Chapter 5</b>	<b>Debug and Programming interface .....</b>	<b>12</b>
<b>Chapter 6</b>	<b>Other circuitry.....</b>	<b>13</b>
6.1	Push button for RESET .....	13
6.2	Mode Selection .....	13
6.3	Signalling LEDs .....	14
<b>Chapter 7</b>	<b>Connectors for ports of device.....</b>	<b>15</b>
7.1	Push button for RESET .....	15
7.2	Connectors to MainBoard.....	15
7.2.1	Connector CN1 .....	15
7.2.2	Connector CN2.....	17
7.2.3	Connector CN3.....	19
<b>Chapter 8</b>	<b>Mechanical dimensions .....</b>	<b>21</b>
<b>Chapter 9</b>	<b>Schematic .....</b>	<b>22</b>
<b>Chapter 10</b>	<b>Revision History .....</b>	<b>25</b>

## Chapter 1 Introduction

The RH850/F1x Application Board is part of the RH850 Evaluation Platform and serves as a simple and easy to use platform for evaluating the features and performance of Renesas Electronics 32-bit RH850/F1x microcontrollers. This piggyback board **Y-RH850-F1X-272PIN-PB-T2-V1** can be used as a standalone board, or can be mated with a mainboard (e.g. Y-RH850-X1X-MB-Tx-Vx) for extended functionality.

Main features:

- Socket for mounting of device
- Standalone operation of the board
- Direct supply of device voltage (typ. 3.3V-5.0V)
- Device programming capability
- Device debugging capability
- Pin headers for direct access to each device pin
- Reset switch
- MainOSC and SubOSC circuitry
- Signal LEDs
- Jumpers for device mode selection
- Connectors to MainBoard

This document describes the functionality provided by the piggyback board and guides the user through its operation.

This manual describes the following board revision:

- Y-RH850-F1X-272PIN-PB-T2-V1

# Chapter 2 Overview

## 2.1 Overview

Figures 1 and 2 provide the views of the Piggyback Board.

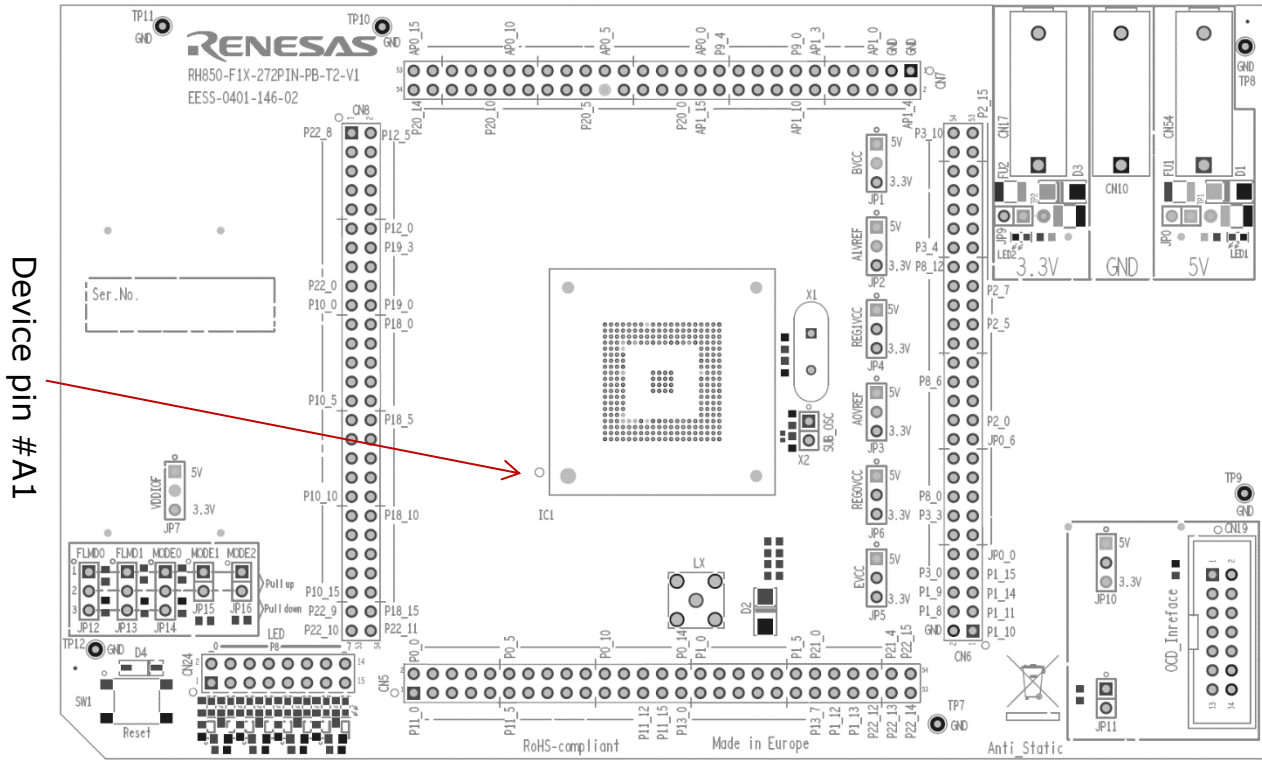

Figure 1 – PiggyBoard top view

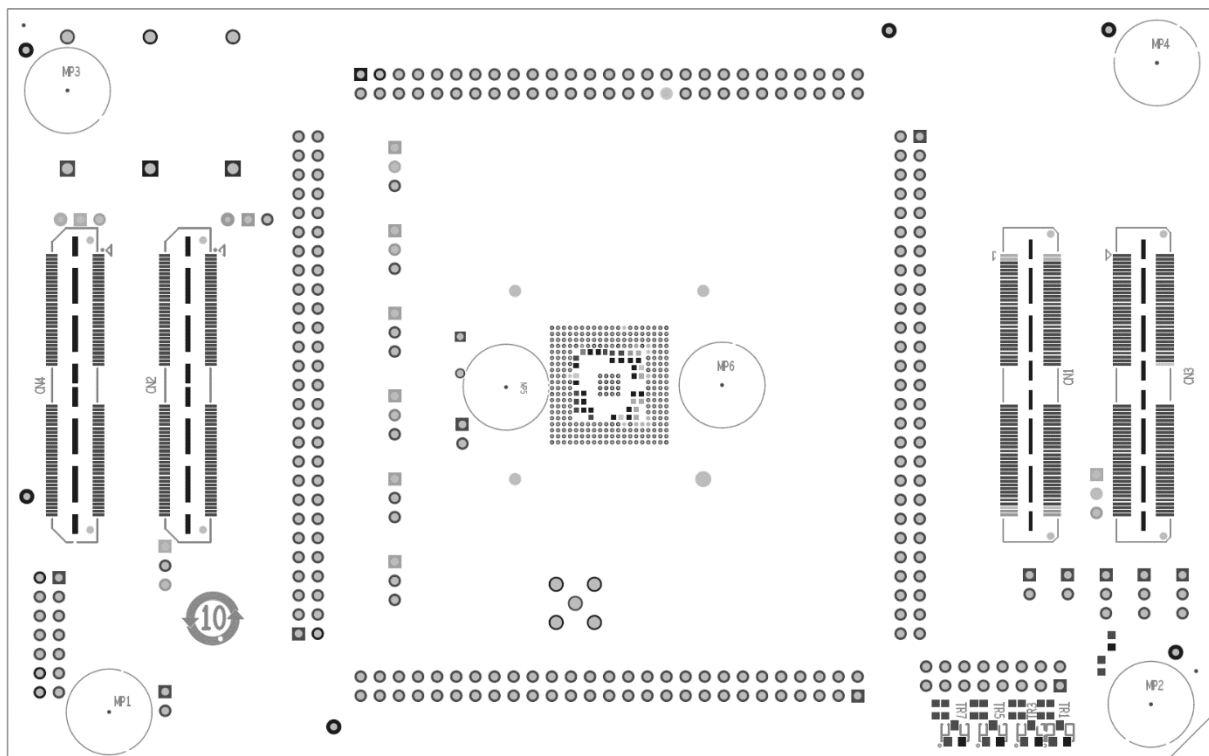

Figure 2 – PiggyBoard bottom view



Figure 3 – Jumper setting overview

- The **green jumper** JP12 for FLMD00 always must be closed for a 'normal' (user mode and debug) operation of the device.
- The **red jumpers** must be set for a "Voltage 1" (typ. +5.0V) operation of the related device supply.
- The **blue jumper** must be set for a "Voltage 2" (typ. +3.3V) operation of the related device supply.

**Note:**

- The RH850/F1KH-D8 device requires a supply voltage of **3.3V** on its **REG1VCC** pin.
- The RH850/F1KM-S4 device requires the **same supply** voltage to be set to **REG0VCC** and **REG1VCC**.

See the section 'Electrical Characteristics' in the device User's Manual for further details.

**For jumper settings related to the device operation mode, refer to the chapter 6.2.**



## Chapter 3 Power supply

### 3.1 Board power connection

For operation of the device, a supply voltage must be connected to the board. Though a single supply voltage is sufficient for the operation of the device, two (different) voltages can be supplied to the board.

Within this document the following voltages are considered as 'typical' connections:

*Voltage1* = 5.0V

*Voltage2* = 3.3V

The following connectors are available to supply those voltages:

- Three 4mm 'banana-type' connectors:
  - Two red connectors for voltages *Voltage1* (CN54) and *Voltage2* (CN17).
  - A black connector for VSS connection (CN10).

**Note:** The three connectors are supplied with the board but not assembled.
- The E1/E2 emulator that is used for debug purposes and flash programming can also supply a single operating voltage ('Dbg\_Voltage'). The voltage is programmable via the E1/E2 GUI as 3.3 or 5.0V (typ). See the documentation of the E1/E2 and chapter 5 'Debug and Programming interface' for details.
- In case the PiggyBoard is mounted on a MainBoard, the voltages *Voltage1* and *Voltage2* are supplied by the on-board regulators of the MainBoard.

**NOTE:** Do not supply any voltage directly to the PiggyBoard in case it is mounted on the MainBoard.

For each of the two voltages, 'Voltage 1' and 'Voltage 2', a green LED (LED1 and LED2) is available to signal that the related voltage is available on the PiggyBoard.

## 3.2 Voltage distribution

The table shows the required device power supply pins and their function:

Device supply pin	Function
REG0VDD REG1VDD	Supply for the device <u>internal regulators</u> for the digital logic.
EVDD	Supply for <u>ports</u> .
BVDD	Supply for <u>ports</u> .
A0VREF	Supply for <u>ports</u> and <u>analog functions</u> of ADC0.
A1VREF	Supply for <u>ports</u> and <u>analog functions</u> of ADC1.
VDDIOF	IO supply voltage for the Mainboard.

- For each of the above voltages, the voltage source can be selected from *Voltage1* (typ. 5.0V) or *Voltage2* (typ. 3.3V) by the jumpers JP1-JP6, JP7, respectively the jumpers JP0, JP9.

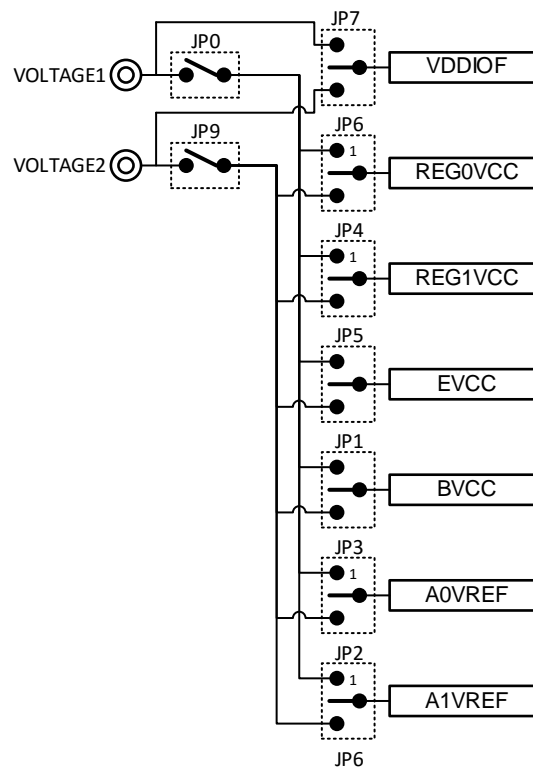

### Note:

- The RH850/F1KH-D8 device requires a supply voltage of **3.3V** on its **REG1VCC** pin.
- The RH850/F1KM-S4 device requires the **same supply** voltage to be set to **REG0VCC** and **REG1VCC**.

See the section 'Electrical Characteristics' in the device User's Manual for further details.

## Chapter 4 Clock sources

Four external crystal oscillators for the device clock supply are provided with the board.

### 4.1.1 MainOsc

A crystal or ceramic resonator in the range of 8MHz to 24MHz can be mounted on socket X1.

A 8MHz, 16MHz and a 20Mhz oscillator is supplied with the board.

### 4.1.2 SubOSC

An oscillator with a frequency of 32.768kHz is supplied with the board and can be soldered into the connector location X2.

## Chapter 5 Debug and Programming interface

For connection of the microcontroller debug and flash programming tools, the connector CN19 is provided.

The signal connection of the connector CN19 is shown in the picture below:

CN19 pin	Device Port	Device signal
1	JP0_2	DCUTCK / LPDCLK
2	GND	GND
3	JP0_4	DCUTRST
4	FLMD0	FLMD0
5	JP0_1	DCUTDO / LPDO
6	P10_8	FLMD1
7	JP0_0	DCUTDI / LPDI
8	'Dbg_Voltage'	-
9	JP0_3	DCUTMS
10	JP0_6	EVTOUT
11	JP0_5	DCURDY / LPDCLKOUT
12	GND	-
13	RESET	-
14	GND	-

\* In case the EVTOUT signal shall be used by the debug/programming tool, the pin header JP11 must be closed.

The 'Dbg\_Voltage' (on CN19 pin 8) is monitored or supplied by the debug and flash programming tools. Therefore, it is necessary to select either Voltage1 (5V) or the Voltage2 (3.3V) by pin header JP10:

JP10 pin	Selection for Dbg_Voltage
1-2	5V is selected
2-3	3.3V is selected

## Chapter 6 Other circuitry

### 6.1 Push button for RESET

In order to issue a RESET to the device, the push-button SW1 is available.

### 6.2 Mode Selection

The PiggyBack Board gives the possibility to configure the following jumpers

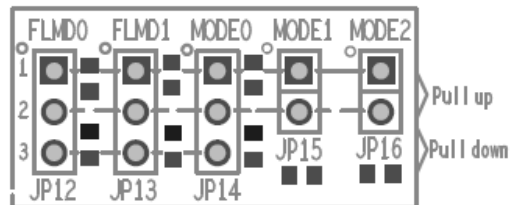

- FLMD0 via jumper JP12
- FLMD1 via jumper JP13
- MODE0 via jumper JP14
- MODE1 via jumper JP15
- MODE2 via jumper JP16

To apply “High” or “Low” to the mode pins, the pins 1 and 2, or the pins 2 and 3 (if available) of the corresponding jumper must be closed, respectively.

Note: Pin 1 of all jumpers is marked by a small circle.

**CAUTION:** Be careful in configuration of mode related pins. Wrong configuration and operation of the device outside of its specification can cause irregular behaviour of the device and long term damage cannot be excluded. Be sure to check the corresponding User’s Manual for details, which modes are specified for the used device.

#### Note:

In the very most cases the ‘Normal operating mode’ of the device will be used. This mode is for execution of the user program. The on-chip debug functions also use this mode.

To select the ‘Normal operating mode’ of the device, the FLMD0 pin must be pulled low. To do so, close the pins 2-3 on the jumper JP12:

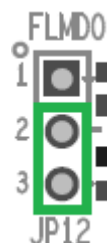

All other jumpers related to the mode selection can be left open.

## 6.3 Signalling LEDs

Eight LEDs are provided to allow visual observation of the output state of device port pins. Device pins P8\_0 to P8\_7 are connected to the even pins 2 to 16 of the pin header CN24, while the LEDs 1 to 8 are connected to the odd pins 1 to 15, respectively.

Thus the LEDs can be either connected to

- the device port pins P8\_0 to P8\_7 by closing the connection on CN24 using a jumper, or
- any device port pin by using the provided wire connections.

## Chapter 7 Connectors for ports of device

Connection to each pin of the device is possible via the connectors CN5 to CN8.

*Note :The pin headers are directly connected to the pins, therefore special care must be taken to avoid any electrostatic or other damage to the device.*

### 7.1 Push button for RESET

In order to issue a RESET to the device, the push-button SW1 is available.

### 7.2 Connectors to MainBoard

Three connectors (CN1 to CN3) are available to connect the PiggyBoard to a MainBoard.

The signal connection of each connector is described in the following tables:

#### 7.2.1 Connector CN1

Pin	Function	Device Port	Pin	Function	Device Port
1	VOLTAGE1	-	2	VOLTAGE1	-
3	VOLTAGE1	-	4	VOLTAGE1	-
5	RESET	_RESET	6	NMI	P9_0
7	WAKE	-	8	-	-
9	INT0	P9_1	10	INT1	P0_6
11	INT2	P9_2	12	INT3	P9_3
13	-	-	14	-	-
15	UART0TX	P0_2	16	UART1TX	P0_5
17	UART0RX	P0_3	18	UART1RX	P0_4
19	LIN0TX	P0_2	20	LIN1TX	P0_8
21	LIN0RX	P0_3	22	LIN1RX	P0_7
23	IIC0SDL	P10_3	24	IIC1SDL	P9_1
25	IIC0SDA	P10_2	26	IIC1SDA	P9_0
27	CAN0TX	P0_1	28	CAN1TX	P10_7
29	CAN0RX	P0_0	30	CAN1RX	P10_6
31	SENTIN0	P8_0	32	SENTIN1	P9_0
33	SENTOUT0	P8_1	34	SENTOUT1	P9_1
35	PSI50Rx	-	36	PSI51Rx	-
37	PSI50Tx	-	38	PSI51Tx	-
39	PSI50Sync	-	40	PSI51Sync	-
41	FLX0TX	P11_1	42	FLX0EN	P10_11
43	FLX0RX	P10_14	44	FLXSTPWT	P10_12
45	FLX1TX	P10_8	46	FX1EN	P10_13

47	FLX1RX	P10_9		48	FX1CLK	P10_10
49	-	-		50	-	-
51	ETH0MDIO	P12_4		52	ETH0MDC	P12_5
53	ETH0RXD0	P10_1		54	EH0TXD0	P18_1
55	ETH0RXD1	P10_2		56	EH0TXD1	P18_2
57	ETH0RXD2	P10_4		58	EH0TXD2	P18_3
59	ETH0RXD3	P10_5		60	EH0TXD3	P18_4
61	ETH0RXDCLK	P10_0		62	ETH0TXCLK	P18_7
63	ETH0RXER	P13_3		64	ETH0TXER	-
65	ETH0CRSDV	P11_12		66	ETH0TXEN	P18_5
67	ETH0RXDV	P11_11		68	ETH0COL	P11_10
69	ETH0RESET	P2_6		70	ETH0LINK	P18_0
71	-	-		72	-	-
73	USB0UDMF	-		74	USB0UDMH	-
75	USB0UDPF	-		76	USB0UDPH	-
77	-	-		78	-	-
79	-	-		80	-	-
81	-	-		82	-	-
83	-	-		84	-	-
85	DIGIO_0	P8_0		86	DIGIO_1	P8_1
87	DIGIO_2	P8_2		88	DIGIO_3	P8_3
89	DIGIO_4	P8_4		90	DIGIO_5	P8_5
91	DIGIO_6	P8_6		92	DIGIO_7	P11_0
93	DIGIO_8	P10_0		94	DIGIO_9	P10_7
95	DIGIO_10	P10_8		96	DIGIO_11	P10_15
97	DIGIO_12	P0_9		98	DIGIO_13	P0_10
99	DIGIO_14	P0_11		100	DIGIO_15	P0_12
101	-	-		102	-	-
103	MUX0	P10_4		104	MUX1	P10_5
105	MUX2	P10_6		106	-	-
107	ADC0	AP0_0		108	ADC1	AP0_1
109	ADC2	AP0_2		110	ADC3	AP0_3
111	ADC4	AP0_4		112	ADC5	AP0_5
113	ADC6	AP0_6		114	ADC7	AP0_7
115	VDDIOF	-		116	VDDIOF	-
117	VOLTAGE2	-		118	VOLTAGE2	-
119	VOLTAGE2	-		120	VOLTAGE2	-



## 7.2.2 Connector CN2

Pin	Function	Device Port	Pin	Function	Device Port
1	CAN2Tx	P0_4	2	CAN3Tx	P1_3
3	CAN2Rx	P0_5	4	CAN3Rx	P1_2
5	CAN4Tx	P1_13	6	CAN5Tx	P0_14
7	CAN4Rx	P1_12	8	CAN5Rx	P0_13
9	LIN2Tx	P0_10	10	LIN3Tx	P1_15
11	LIN2Rx	P0_9	12	LIN3Rx	P1_14
13	LIN4Tx	P1_11	14	LIN5Tx	P8_12
15	LIN4Rx	P1_10	16	LIN5Rx	P8_11
17	LIN6Tx	P0_12	18	LIN7Tx	P12_4
Q	LIN6Rx	P0_11	20	LIN7Rx	P12_3
21	LIN8Tx	P2_3	22	LIN9Tx	P2_5
23	LIN8Rx	P2_2	24	LIN9Rx	P2_4
25	LIN10Tx	P8_2	26	LIN11Tx	P10_12
27	LIN10Rx	P8_10	28	LIN11Rx	P10_11
29	LIN12Tx	P0_14	30	LIN13Tx	P1_1
31	LIN12Rx	P0_13	32	LIN13Rx	P1_0
33	LIN14Tx	P8_9	34	LIN15Tx	P1_5
35	LIN14Rx	P8_8	36	LIN15Rx	P1_4
37	-	-	38	-	-
39	-	-	40	-	-
41	MLBCLK	-	42	MLBRESET	-
43	MLBSIG	-	44	MLBDAT	-
45	-	-	46	-	-
47	CAN6Tx	P8_1	48	CAN7Tx	P8_3
49	CAN6Rx	P8_0	50	CAN7Rx	P8_4
51	CAN8Tx	P3_4	52	CAN9Tx	P3_6
53	CAN8Rx	P3_3	54	CAN9Rx	P3_5
55	CAN10Tx	P3_8	56	CAN11Tx	P3_10
57	CAN10Rx	P3_7	58	CAN11Rx	P3_9
59	-	-	60	-	-
61	LIN16Tx	P11_15	62	LIN17Tx	P8_2
63	LIN16Rx	P12_0	64	LIN17Rx	P8_10
65	LIN18Tx	P11_2	66	LIN19Tx	P2_8
67	LIN18Rx	P11_3	68	LIN19Rx	P2_7
69	LIN20Tx	P2_13	70	LIN21Tx	-
71	LIN20Rx	P2_12	72	LIN21Rx	-
73	LIN22Tx	-	74	LIN23Tx	-
75	LIN22Rx	-	76	LIN23Rx	-
77	LIN14Tx	-	78	LIN14Rx	-
79	SFMA0CLK	P11_7	80	SFMA0SSI	P11_6

81	SFMA0IO0	P11_5
83	SFMA0IO2	P11_3
85	-	-
87	MMCA0DAT6	-
89	MMCA0DAT4	-
91	MMCA0DAT2	-
93	MMCA0DAT0	-
95	MMCA0CLK	-
97	-	-
99	ETNB1RESET	-
101	ETNB1RXD3	-
103	ETNB1RXCLK	-
105	ETNB1RXERR	-
107	ETNB1CRSDV	-
109	ETNB1RXDV	-
111	ETNB1MDIO	-
113	ETNB1RXD0	-
115	ETNB1RXD2	-
117	ETNB1RXD1	-
119	-	-

82	SFMA0IO1	P11_4
84	SFMA0IO3	P11_2
86	-	-
88	MMCA0DAT1	-
90	MMCA0DAT5	-
92	MMCA0DAT7	-
94	MMCA0CMD	-
96	MMCA0DAT3	-
98	-	-
100	ETNB1LINK	-
102	ETNB1TXERR	-
104	ETNB1TXCLK	-
106	ETNB1TXD3	-
108	ETNB1TXEN	-
110	ETNB1COL	-
112	ETNB1TXD2	-
114	ETNB1TXD1	-
116	ETNB1MDC	-
118	ETNB1TXD0	-
120	-	-

### 7.2.3 Connector CN3

Pin	Function	Device Port	Pin	Function	Device Port
1	PWM00	P10_0	2	PWM01	P10_1
3	PWM02	P10_2	4	PWM03	P10_3
5	PWM04	P10_7	6	PWM05	P10_8
7	PWM06	P10_9	8	PWM07	P10_10
9	PWM08	P9_0	10	PWM09	P9_1
11	PWM10	P0_4	12	PWM11	P0_1
13	PWM12	P0_2	14	PWM13	P0_3
15	PWM14	P8_0	16	PWM15	P8_1
17	PWM16	P10_11	18	PWM17	P10_12
Q	PWM18	P10_13	20	PWM19	P10_14
21	PWM20	P9_2	22	PWM21	P9_3
23	PWM22	P8_2	24	PWM23	P8_3
25	PWM24	P10_15	26	PWM25	P11_0
27	PWM26	P11_1	28	PWM27	P11_2
29	PWM28	P11_3	30	PWM29	P11_4
31	PWM30	P11_5	32	PWM31	P11_6
33	PWM32	P11_7	34	PWM33	P9_4
35	PWM34	P0_11	36	PWM35	P0_6
37	PWM36	P8_4	38	PWM37	P8_5
39	PWM38	P8_6	40	PWM39	P8_7
41	PWM40	P8_8	42	PWM41	P8_9
43	PWM42	P8_10	44	PWM43	P8_11
45	PWM44	P8_12	46	PWM45	P0_12
47	PWM46	P0_13	48	PWM47	P0_14
49	PWM48	P11_8	50	PWM49	P11_9
51	PWM50	P11_10	52	PWM51	P11_11
53	PWM52	P11_12	54	PWM53	P10_4
55	PWM54	P10_5	56	PWM55	P11_15
57	PWM56	P12_0	58	PWM57	P12_1
59	PWM58	P12_2	60	PWM59	P20_4
61	PWM60	P20_5	62	PWM61	P18_0
63	PWM62	P18_1	64	PWM63	P18_2
65	PWM64	P20_0	66	PWM65	P20_1
67	PWM66	P20_2	68	PWM67	P20_3
69	PWM68	P12_3	70	PWM69	P12_4
71	PWM70	P12_5	72	PWM71	P18_3
73	PWM72	P13_6	74	PWM73	P13_7
75	PWM74	P2_14	76	PWM75	P2_15
77	PWM76	P3_0	78	PWM77	P2_9
79	PWM78	P2_10	80	PWM79	P2_11

81	PWMADC00	AP0_8
83	PWMADC02	AP0_10
85	PWMADC04	AP0_12
87	PWMADC06	AP0_14
89	PWMADC08	AP1_0
91	PWMADC10	AP1_2
93	PWMADC12	AP1_4
95	PWMADC14	AP1_6
97	-	-
99	-	-
101	-	-
103	-	-
105	-	-
107	-	-
109	-	-
111	-	-
113	-	-
115	-	-
117	-	-
119	-	-

82	PWMADC01	AP0_9
84	PWMADC03	AP0_11
86	PWMADC05	AP0_13
88	PWMADC07	AP0_15
90	PWMADC09	AP1_1
92	PWMADC11	AP1_3
94	PWMADC13	AP1_5
96	PWMADC15	AP1_7
98	-	-
100	-	-
102	-	-
104	-	-
106	-	-
108	-	-
110	-	-
112	-	-
114	-	-
116	-	-
118	-	-
120	-	-

## Chapter 8 Mechanical dimensions

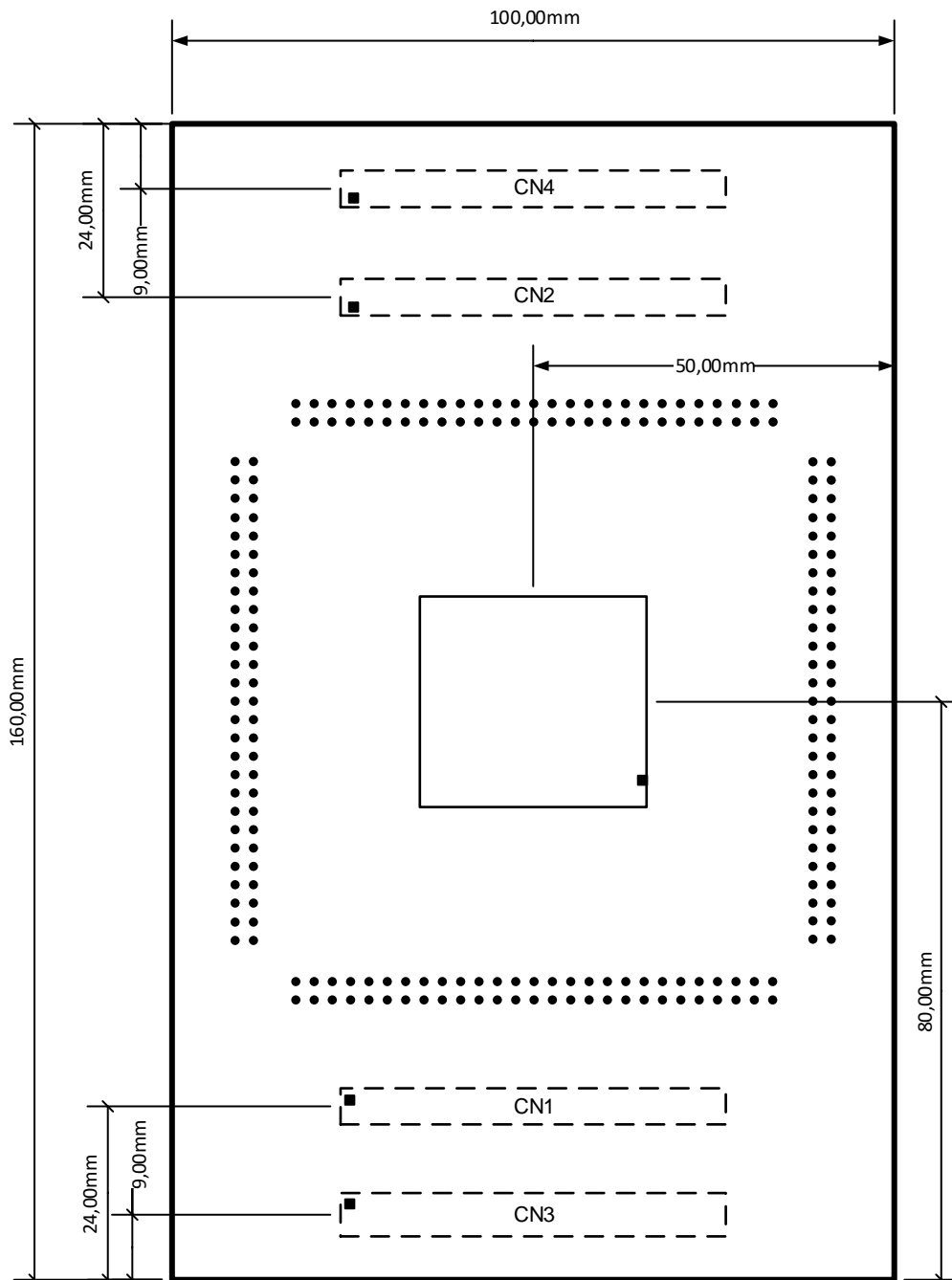

# Chapter 9 Schematic

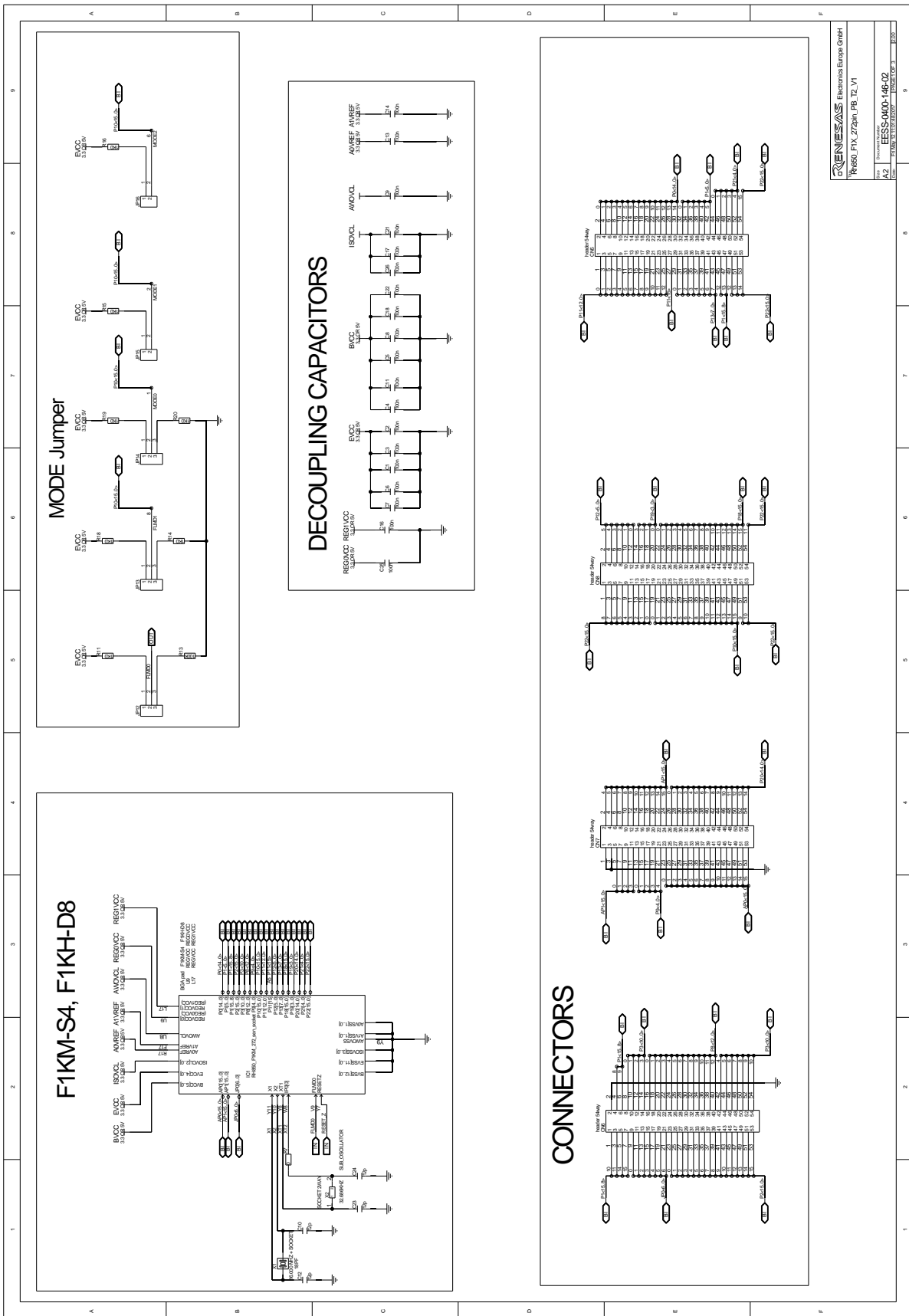

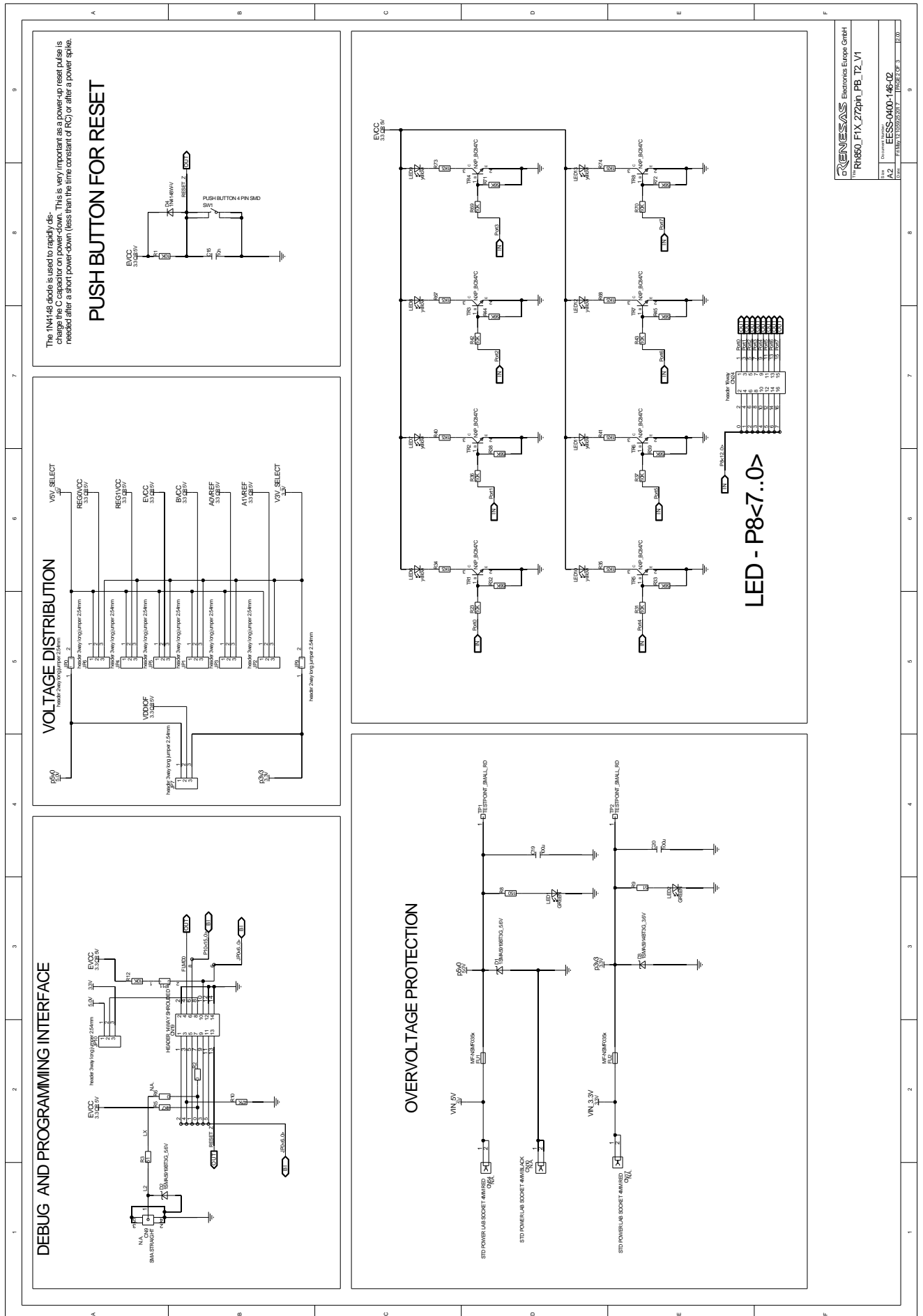

RENESESAS		Electronics Europe GmbH	
The		RH850_F1X_272pin_PB_T2_V1	
Rev.	Doc. Name	Doc. No.	Doc. Date
A2	EES5-0400-146-02	F1KH-D8_272PIN-PB-T2-V1	2017-07-12





## Chapter 10 Revision History

The table provides information about the major changes of the document versions.

Date	Version	Description
2017-07-12	1.0	Initial release

**SALES OFFICES****Renesas Electronics Corporation**<http://www.renesas.com>

---

Refer to "<http://www.renesas.com/>" for the latest and detailed information.**Renesas Electronics America Inc.**2801 Scott Boulevard Santa Clara, CA 95050-2549, U.S.A.  
Tel: +1-408-588-6000, Fax: +1-408-588-6130**Renesas Electronics Canada Limited**9251 Yonge Street, Suite 8309 Richmond Hill, Ontario Canada L4C 9T3  
Tel: +1-905-237-2004**Renesas Electronics Europe Limited**Dukes Meadow, Millboard Road, Bourne End, Buckinghamshire, SL8 5FH, U.K  
Tel: +44-1628-585-100, Fax: +44-1628-585-900**Renesas Electronics Europe GmbH**Arcadiastrasse 10, 40472 Düsseldorf, Germany  
Tel: +49-211-6503-0, Fax: +49-211-6503-1327**Renesas Electronics (China) Co., Ltd.**Room 1709, Quantum Plaza, No.27 ZhiChunLu Haidian District, Beijing 100191, P.R.China  
Tel: +86-10-8235-1155, Fax: +86-10-8235-7679**Renesas Electronics (Shanghai) Co., Ltd.**Unit 301, Tower A, Central Towers, 555 Langao Road, Putuo District, Shanghai, P. R. China 200333  
Tel: +86-21-2226-0888, Fax: +86-21-2226-0999**Renesas Electronics Hong Kong Limited**Unit 1601-1611, 16/F., Tower 2, Grand Century Place, 193 Prince Edward Road West, Mongkok, Kowloon, Hong Kong  
Tel: +852-2265-6688, Fax: +852 2886-9022**Renesas Electronics Taiwan Co., Ltd.**13F, No. 363, Fu Shing North Road, Taipei 10543, Taiwan  
Tel: +886-2-8175-9600, Fax: +886 2-8175-9670**Renesas Electronics Singapore Pte. Ltd.**80 Bendemeer Road, Unit #06-02 Hyflux Innovation Centre, Singapore 339949  
Tel: +65-6213-0200, Fax: +65-6213-0300**Renesas Electronics Malaysia Sdn.Bhd.**Unit 1207, Block B, Menara Amcorp, Amcorp Trade Centre, No. 18, Jln Persiaran Barat, 46050 Petaling Jaya, Selangor Darul Ehsan, Malaysia  
Tel: +60-3-7955-9390, Fax: +60-3-7955-9510**Renesas Electronics India Pvt. Ltd.**No.777C, 100 Feet Road, HAL II Stage, Indiranagar, Bangalore, India  
Tel: +91-80-67208700, Fax: +91-80-67208777**Renesas Electronics Korea Co., Ltd.**12F., 234 Teheran-ro, Gangnam-Gu, Seoul, 135-080, Korea  
Tel: +82-2-558-3737, Fax: +82-2-558-5141

---