

# RTKA-BDGSTKEV1Z

## User's Manual: Evaluation Board

### Industrial Analog and Power

All information contained in these materials, including products and product specifications, represents information on the product at the time of publication and is subject to change by Renesas Electronics Corp. without notice. Please review the latest information published by Renesas Electronics Corp. through various means, including the Renesas Electronics Corp. website (<http://www.renesas.com>).

RTKA-BDGSTKEV1Z

DAQ on a Stick, Strain Gauge with Programmable Chopper Stabilized IN-Amp

The DAQ on a Stick, Strain Gauge with Programmable IN-Amp is one of a series of reference designs highlighting Renesas precision products. This reference design is a self-contained demo showing a complete signal chain solution using Renesas precision parts and a Renesas microcontroller. The complete reference design is conveniently housed in a USB stick form factor. This compact design draws power through the USB port and uses a Graphical User Interface (GUI) to display the real-time voltage readings from a bridge strain gauge or a user-supplied sensor. [Figure 1](#) shows the Data Acquisition (DAQ) on a Stick connected to an external foil strain gauge.

[Figure 2](#) shows a simplified schematic of the Strain Gauge design. The design uses the Renesas ISL28634 Programmable Instrumentation Amplifier (IN-Amp), ISL23328 Digital Potentiometer, ISL28233 Operational Amplifiers, ISL43840 dual 4-channel Mux configured as a Differential Mux, ISL21010 3.3V and 4.096V precision voltage references, ISL26104 24-Bit Delta Sigma Converter, and R5F10JBC (RL78/G1C) Microcontroller.

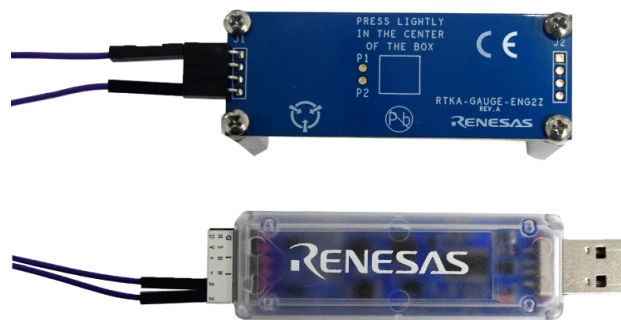

Figure 1. DAQ on a Stick with Strain Gauge

Ordering Information

Part Number	Description
RTKA-BDGSTKEV1Z	Evaluation Board

Related Literature

For a full list of related documents, visit our website:

- [ISL28634](#), [ISL28233](#), [ISL21010](#), [ISL26104](#), [ISL43840](#), [ISL23328](#), and [R5F10JBC](#) device pages

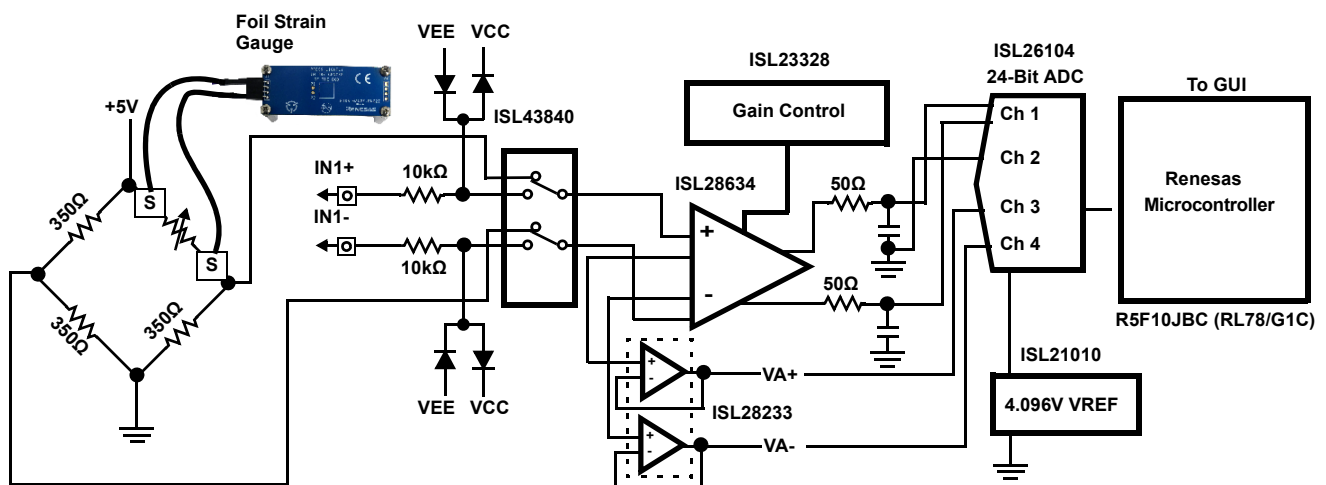

Figure 2. Simplified Strain Gauge Schematic

## 1. Getting Started

### 1.1 Installing the Software and USB Drivers

The software and USB drivers must be installed on a PC running Windows NT/2000/XP/Vista/Win7/Win8/Win10 operating system before connecting the RTKA-BDGSTKEV1Z evaluation board to the USB port.

The software and a short video on the operation of this application demonstration can be downloaded or viewed from the Renesas [website](#).

### 1.2 Loading the Software

1. From the website, click the **Downloads** tab, then click the **Renesas DAQ on a Stick Software** link to load the executable.
2. Follow the on-screen instructions to complete the software installation. The installation program places the user interface software in the C:\Program Files\R12UZ0048\_DAQ\_V250 directory.
3. To create a shortcut on your desktop, check the **Create A Desktop Icon** box during the software installation.
4. Launch the application by checking the **Launch R12UZ0048\_DAQ\_V250** box, then click **Finish**.

### 1.3 Overview of the Demonstration Software

The primary goal of the demonstration software is to provide a real-time graphical display of data collection. The GUI contains a Startup Screen and a Measurement Display Screen.

#### 1.3.1 Startup Screen

The Startup Screen ([Figure 3 on page 4](#)) allows you to perform the following configurations:

- Verify the software is communicating with the board.
- Select the sensor to be measured.
- Select system gain (if the **Customer Supplied** sensor is selected).
- Select the input to the ADC.

#### 1.3.2 Measurement Display Screen

The Measurement Display Screen ([Figure 6](#)) allows you to perform the following functions:

- Take and view measurement data.
- Select the units of measure (either volts or microstrain).
- Calibrate the initial reading to zero.
- Adjust the range of both the x and y axis of the graph.

The Measurement Display Screen also allows you to export the collected data for further analysis.

## 2. Running the Evaluation Software

1. After the software is installed and the Setup Screen in [Figure 3](#) appears, plug the RTKA-BDGSTKEV1Z board into a USB port on the computer. The green LED on the RTKA-BDGSTKEV1Z turns on.

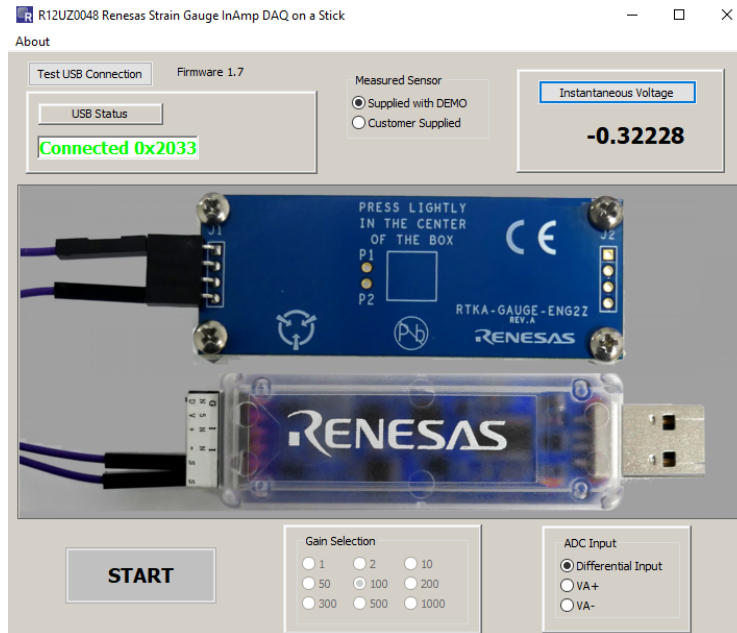

Figure 3. Startup Screen

2. With the RTKA-BDGSTKEV1Z connected, the USB Status indicator displays “Connected 0x2033”. The assigned HID PID code for this application is 0x2033. This code is verification the software is communicating with the board.

**Note:** If the RTKA-BDGSTKEV1Z is not connected, or a problem exists with the demo, the message reads “HID Device Not Found”. If this occurs, click **Test USB Connection** to enable the connection. If the connection is still not enabled, disconnect and reconnect the device or restart the software.

3. From the Startup Screen ([Figure 3](#)), click **Instantaneous Voltage** to get a single voltage reading, select the sensor input to measure, adjust the amplifier gain, or click **Start** to go to the Measurement Display screen shown in [Figure 6 on page 8](#). The green LED on the board turns off.

**Note:** You can launch the software by clicking the Renesas DAQ shortcut (created in the previous step) on the desktop. [Figure 4](#) shows the desktop icon.

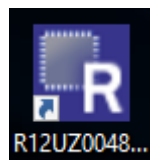

Figure 4. Desktop Icon

### 3. Connecting the Sensor

The RTKA-BDGSTKEV1Z reference design gives you the option to measure the strain on an internal bridge with a foil gauge (supplied with the evaluation board) or connect an external sensor to monitor the voltage reading on the GUI screen. Select the **Supplied with DEMO** sensor or **Customer Supplied** sensor by clicking the appropriate radial button at the top of the Startup Screen shown in [Figure 3](#). The **Supplied with the DEMO** sensor (foil gauge) is the default value in the software with a gain of 100V/V. [Figure 5](#) shows the external connector inputs that connect the sensor to the circuit shown in [Figure 2 on page 2](#).

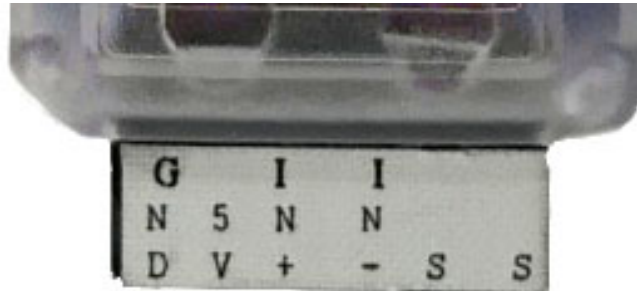

Figure 5. Sensor Connector

#### 3.1 Connecting the Foil Strain Gauge

The foil gauge is supplied with the evaluation board. Complete the following steps to connect the foil gauge.

1. Plug the wires into the “S” ports (either top row or the bottom row; the columns are connected) on the DAQ on a Stick.
2. Connect the opposite end of the wires to the far edges of the foil gauge board. See [Figure 5](#).

#### 3.2 Connecting the User Supplied Sensor

To connect your own sensor, complete the following steps.

1. Plug the wires into the IN+ and IN- ports shown in [Figure 5](#).
2. Select **Customer Supplied** in the Startup Screen. This selection causes the ISL43840 to be configured as a differential mux to switch the inputs. When the **Customer Supplied** option is selected, you can change the amplifier’s gain for the best measurement.

The DAQ on a Stick also provides a 5V supply and ground connection for use by your sensor network.

## 4. Using the Startup Screen

### 4.1 Test USB Connection Button

The **Test USB Connection** button performs the USB connection sequence. The version of the firmware is automatically listed beside the **Test USB Connection** button.

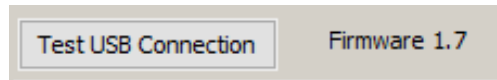

### 4.2 Instantaneous Voltage Button

The **Instantaneous Voltage** button performs an immediate read of the ADC.

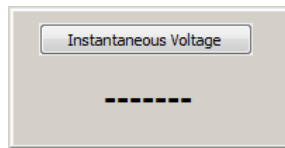

The button also provides further verification that the evaluation board is functional.

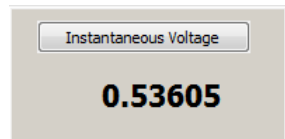

### 4.3 Measured Sensor Radio Box

The **Measured Sensor** radio box has two selections for the sensor type: **Supplied with DEMO** and **Customer Supplied**. The radio box enables only one active selection at a time.

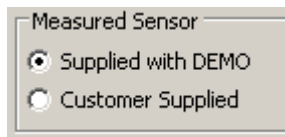

If the **Supplied with DEMO** sensor is selected, the amplifier gain is fixed at 100 and the gain selection box is grayed out. If the **Customer Supplied** sensor is selected, the amplifier gain can be changed using the **Gain Selection** box.

### 4.4 Gain Selection Radio Box

When you select the **Customer Supplied** sensor option, the **Gain Selection** radio box is enabled, allowing you to select from one of nine programmable gains of the ISL28634 Programmable Instrumentation Amplifier. For other available gain options, see the full datasheet for the [ISL28533](#) and [ISL28633](#) family of instrumentation amplifiers.

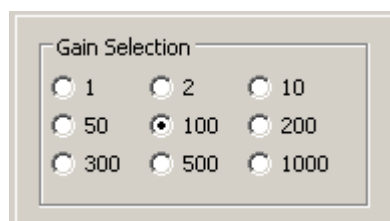

#### 4.5 ADC Input Radio Box

The ISL26104 is a quad input 24-bit ADC. Select the input by clicking the radio box button in the **ADC Input** box shown below.

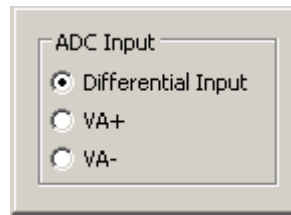

Selecting **Differential Input** connects the channel measuring the output of the PGIA. Selecting the **VA+** or **VA-** radial button measures the output of either the VA+ or the VA- pin. The VA+ and VA- pins assess the health of the sensor or use the pre-summing difference signal for advanced digital compensation.

#### 4.6 Startup Screen Menu Bar

The Menu bar is located at the top of the Startup Screen. Click **About** to show the drop down menu that opens a new window with information about the GUI version and the firmware version.

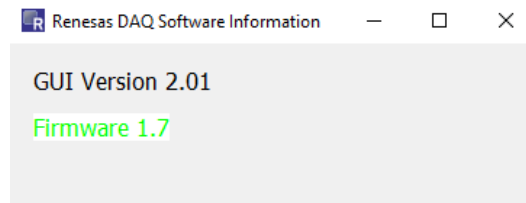

#### 4.7 Start Button to Measurement Display Screen

The **Start** button at the bottom left of the Startup Screen loads the Measurement Display Screen shown in [Figure 6 on page 8](#).



## 5. Using the Measurement Display Screen

After clicking **Start** on the Startup Screen, the Measurement Display Screen appears ([Figure 6](#)).

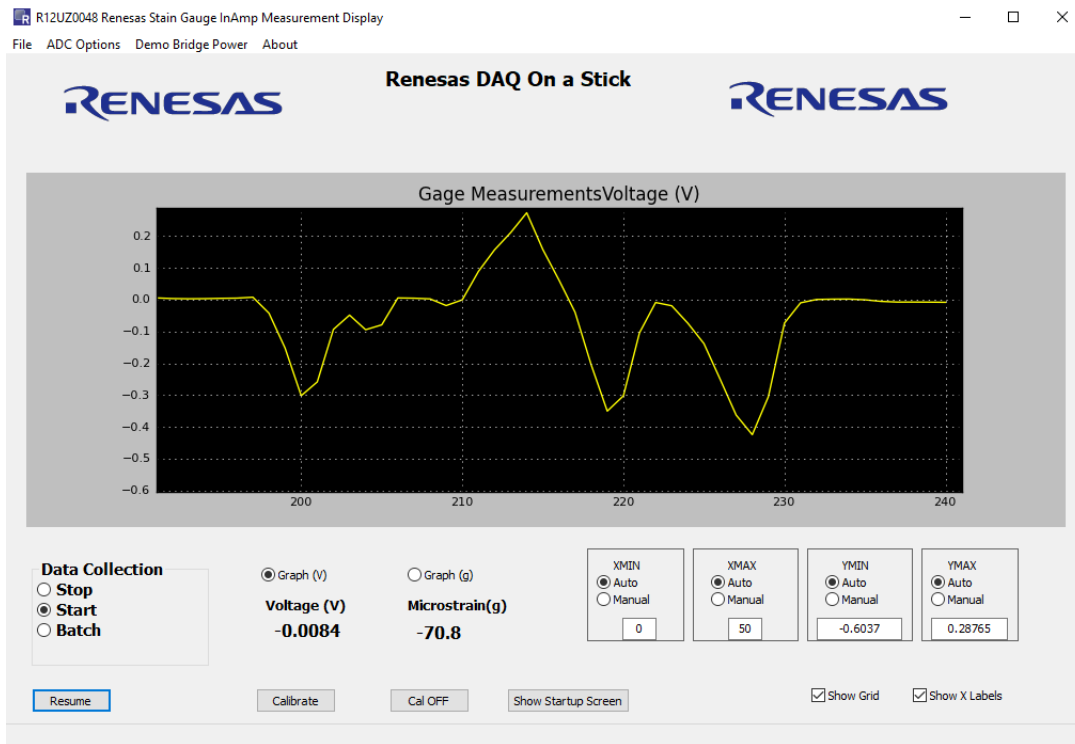

**Figure 6. Measurement Display Screen**

From this screen you can do the following:

- Start and stop data collection.
- Select the scaling of the Y axis (**Voltage (V)** or **Microstrain (g)**).
- Adjust the scaling of the X and Y axes (**Auto** or **Manual**).
- Remove any offsets with the **Calibrate** button.

The Menu bar at the top of the Measurement Screen provides additional functionality. See [“Measurement Display Menu Options” on page 10](#) for more details.

### 5.1 Data Collection Radio Box

The **Data Collection** radio box is one of the most actively used controls.

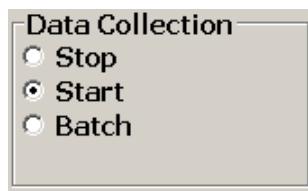

- **Start** begins data collection and graphing in real-time of the measured ADC values.
- **Stop** halts data collection.
- **Batch** enters a “Capture then Display” mode where data is collected for 1024 measurements and displayed all at once.

Batch mode collects periodic waveforms where the overhead of real-time graphing would result in missed measurements. See [“Measuring Batch Mode Throughput” on page 16](#).



### 5.2 Graphing Radio Box

The **Supplied with DEMO** sensor option from the Startup Screen provides options to display the measured strain in either Voltage (**Graph (V)** button) or Microstrain (**Graph (g)** button) as shown. See ["Measurement in Microstrain" on page 13](#) to calculate microstrain units in grams.

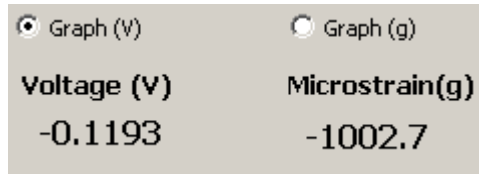

If you select the **Customer Supplied** sensor from the Startup Screen, the reading in the **Graphing** radio box is automatically displayed in Voltage.

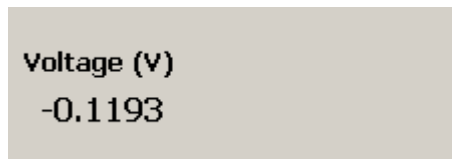

In either case, the measured ADC Voltage (V) and Microstrain (g) are updated in the display below the radial buttons (shown in bold font) as data collection proceeds.

### 5.3 Calibrate Button

The **Calibrate** button removes an offset from the measured ADC value in Volts.



The offset helps give an accurate reading from time zero and is required because the board does not always return to the same deflection point after a strain is applied to the board. If the **Calibrate** button is selected, the initially measured value is subtracted from all subsequent ADC Voltage readings. To return back to the non-calibrated condition, click the **Cal OFF** button.

**Note:** The calibrated offset value is saved at the top of the exported .csv files, along with ADC sample/sec, channel being measured, status of flushing, Gauge Factor, Gain, and Gain Factor.

### 5.4 Graphing X and Y Axis Control

The graphing windows enable control of the graph area horizontal (XMIN, XMAX) and vertical (YMIN, YMAX) axes.

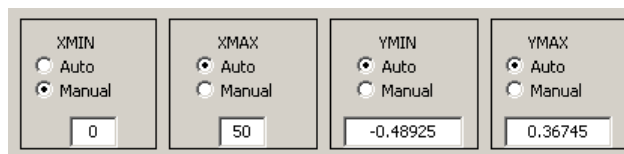

With **Auto** selected, the last 50 measurements are displayed as data collection runs, which produces a horizontal scrolling of the data.

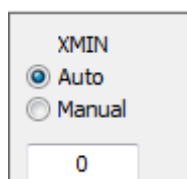

To see the history of the sensor reading from the beginning, pin the X axis to 0 by clicking the **Manual** button in the **XMIN** box with the value in the selection window at 0.

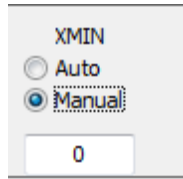

Enter other values in the selection window to jump to those locations.

The Y axis is automatically adjusted as data is collected. However, when graphing “flat line” waveforms, you can select **Manual** while data collection is running and zoom the Y axis in to see further detail.

During initialization, the controls are set to **Auto**. When started, you can select the **Manual** radio button and change the Y axis as desired.

**Note:** The axis controls affect the graph display area only. During data export, all data collected, regardless of graph scaling, is sent to the .csv file.

### 5.5 Grid and X Labels Check Boxes

The **Show Grid** and **Show X Labels** check boxes are graphing display options. Disable (deselect) **Show Grid** or **Show X Labels** to speed up the real-time graphing display. These options can be enabled or disabled at any time.

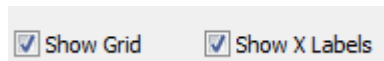

### 5.6 Show Startup Screen Button

The **Show Startup Screen** button re-displays the Startup Screen.



If clicked more than once, the Startup form can be hidden behind the Measurement form. You can move the forms so both can be viewed simultaneously.

### 5.7 Measurement Display Menu Options

The Measurement Display has a menu bar at the top.

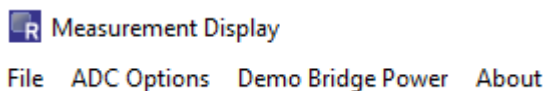

- **File** exports collected data to a .csv file and captures a picture of the graph display.
- **ADC Options** sets the ADC Sample rate and the ADC Channel and enables/disables “flushing” during real-time data collection (flushing is always disabled when using Batch mode data collection). See [“Real-Time Graph Options and Flushing” on page 16](#).
- **Demo Bridge Power** turns on and off the power provided from the DAQ on a Stick.
- **About** shows the schematic of the DAQ on a Stick and offers another way for you to read the firmware version.

These items are discussed in more details in the following sections.

### 5.7.1 File

In the **File** menu options, click **Save Chart** to save an image of the graph or click **Export Data** to export the collected data to a .csv file to import it into other applications.

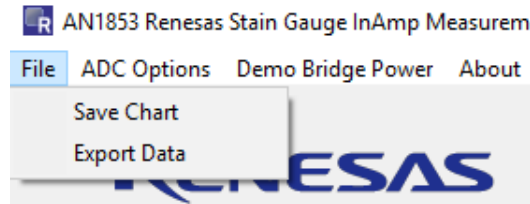

### 5.7.2 ADC Options

The **ADC Options** menu has three sections that are made up of radio box selections.

- **ADC Word Rate** programs the ISL26104 ADC samples per second. See the ISL26104 datasheet for more detail about sampling rates. The **ADC Input** selection determines which ISL26104 channel is measured; Channel 1 is the output of ISL28634, Channel 2 has both inputs grounded, Channel 3 is the VA+ output of the ISL28634, and Channel 4 is the VA- output of the ISL28634.

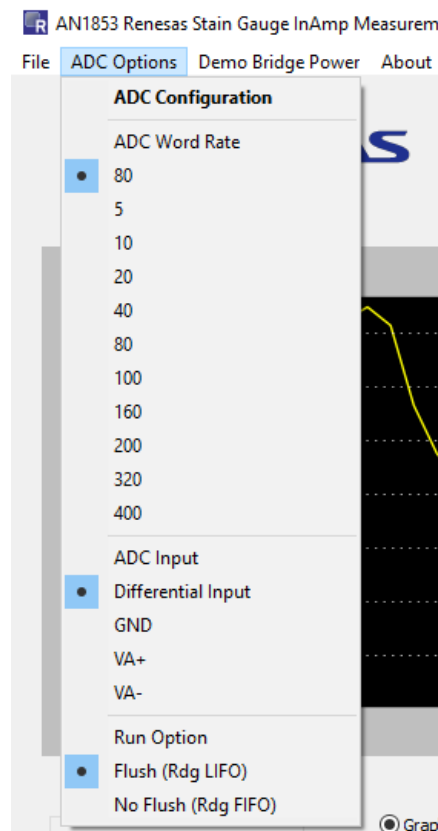

### 5.7.3 Demo Bridge Power

The **Demo Bridge Power** menu turns the power to the internal bridge, provided from the DAQ on a Stick (Figure 3 on page 4), on and off.

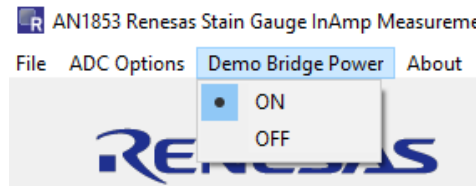

### 5.7.4 About

The **About** menu provides a schematic of the DAQ on a Stick circuit and provides another path, other than the one on the Startup Screen, to view the version of the GUI and firmware.

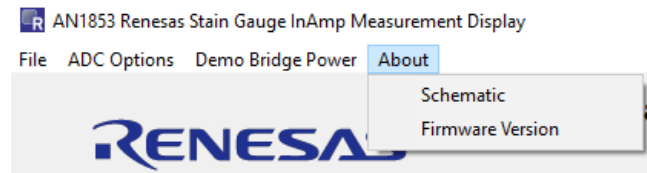

## 6. Measurement in Microstrain

### 6.1 Voltage and Calculated Measurement Discussion

If you select the **Customer Supplied** sensor from the Startup Screen, you can display the measured strain in either Voltage (V) or Microstrain (g). The Microstrain (g) is calculated based on the characteristics of the Vishay Foil Strain gauge. To calculate the microstrain units, see [Equation 1](#).

$$(EQ. 1) \quad \text{Microstrain(g)} = (A_V \text{PGIA}) \times \text{Cal}_{\text{FACTOR}} \times \text{Gain}_{\text{FACTOR}}$$

where:

- Microstrain is calibrated in grams.
- $A_V \text{PGIA} = 100$ , the ISL28634 gain in this configuration.
- $\text{Cal}_{\text{FACTOR}} = 0.119\text{V}$ , empirically measured with 1kg weight.
- $\text{Gain}_{\text{FACTOR}} = 84.033$ . This value is calculated so the microstrain units read 1kg when the ADC's output is 0.119V.

<input checked="" type="radio"/> Graph (V)	<input type="radio"/> Graph (g)
<b>Voltage (V)</b>	<b>Microstrain(g)</b>
-0.1193	-1002.7

#### 6.1.1 Voltage and Calibration Offset

Voltage (V) is based on the raw ADC reading and does not include adjustments for Gain.

<input checked="" type="radio"/> Graph (V)
<b>Voltage (V)</b>
-0.1196

However, voltage can be affected if you click **Calibrate** during data collection. The **Calibrate** button removes fixed offsets that can occur when a sensor is dormant.

---

## 7. General Notes and Background

### 7.1 Demonstration General Goals

The primary goal of Renesas signal path demonstrations is to provide a real-time graph display of data collection. The demonstration needs to be quickly responsive to changes in sensor readings as you make changes to the input. However, real-time graphing overhead and USB buffering and flushing can lead to latency in the perceived time it takes the graph to respond.

#### 7.1.1 Real-Time Graphing Overhead

Creating a graph in real-time involves instruction overhead. You can view the influence of graph overhead by enabling and disabling the grid background. With the grid enabled, the graph “scrolls” more slowly than with the grid disabled.

#### 7.1.2 USB Buffering and Flushing

Another influence on real-time graphing is the buffering of USB pipe information. The goal of buffering is to avoid lost packets and/or decrease transfer Non-Acknowledge (NAK). NAKs lead to an increase in overhead of actual data throughput.

To avoid the latency introduced by buffering, a USB function known as “Flush Buffer” is available on the GUI. When a “flush” is executed, essentially all buffered “reports” are tossed aside and the latest information is obtained by the GUI application on the next “USB Read” operation.

The advantage of flushing is that the latest influence of operator interaction is immediately available for graphing. Without flushing, several readings are displayed before the operator interaction appears in the graph.

The influence of these delays can produce a hysteresis in the real-time graphing. They can lead to a time delay where you press on the strain gauge, but the change is not displayed for a few seconds. This can result in confusion or dissatisfaction with performance during a demonstration.

### 7.2 Evaluation Board Firmware Discussion

During the initial development, a simple exchange was implemented. The GUI sent a USB request for a reading, the firmware received the request, obtained a reading, and sent it. Later versions used a method where readings streamed continuously without the need for the application to repeat the request for another reading. Still later versions employed the ability to start and stop the streaming so the ADC could be stopped, re-programmed to use a different channel or sampling rate, and started again.

#### 7.2.1 Overview of USB Communications Parameters

The GUI and the evaluation board firmware communicate over the USB bus. The evaluation board firmware complies with the Windows operating system HID requirements. No special driver is needed to communicate with the evaluation board firmware. The communications use the Windows built-in USB “HID” driver. Both the Python GUI and the firmware make use of “Case” statements with the USB buffer being examined to enable various functions.

### 7.3 ADC Sampling Rates and USB Flushing

When programmed, the Renesas ISL26104 ADC is constantly making measurements and signaling the completion of each measurement. Most demonstrations have run with a sampling rate of 80 readings per second. However, while the ADC is completing readings at this rate, the overhead of real-time graphing and use of flushing means that not all measurements are actually being displayed. This is acceptable when dealing with sporadic operator influences and providing immediate feedback/display of those influences.

Conversely, when reproducing a periodic signal such as a voltage ramp or sine wave, the primary goal of immediate display of sporadic changes fails. With periodic waveform analysis, the emphasis is on the capture of an uninterrupted/complete batch of measurements, essentially leaving real-time and moving to a “Batch: capture then display” operation.

## 7.4 Benchmarking Application Measurement Throughput

The most recent firmware enables the transmission of all measurements. The firmware uses an interrupt that triggers whenever the ADC has completed a reading. Upon this interrupt, the ADC reading is collected over the SPI interface and a report is scheduled for transmission over the USB.

Even with this firmware design, there was a need at the application end to monitor whether all readings are getting through. Overhead tied to Windows, USB HID, and the application itself could result in missed measurements. Furthermore, different computers can run at slower speeds. Therefore, a way to monitor the performance of the total throughput is also needed so you can assess the performance of a particular installation.

To meet this monitoring need, a fourth byte is also transmitted with the ADC reading. This byte is tagged as the “Firmware Count” and is a single byte that is incremented each time a reading is transmitted. This fourth byte enables the appraisal of the total application throughput. If all readings are being processed, a perfect sawtooth is seen as part of the measurement data shown in [Figure 7](#). The value should count up, roll over at 255, and repeat the process. Missing or skipped values indicate an incomplete measurement stream. See [“Measuring Throughput”](#) for more information about firmware count.

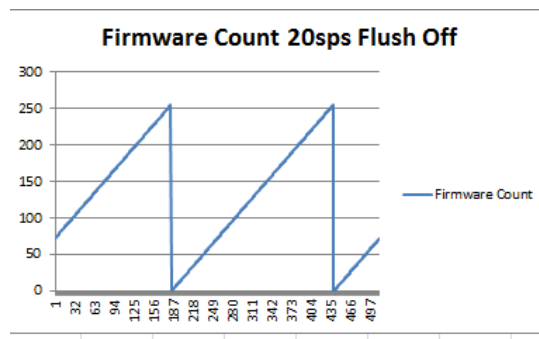

Figure 7. Verification of Throughput

## 7.5 Measuring Throughput

The Sensor Measurement application’s speed can be affected by operating system, speed/type of processor, and number of other windows or applications running concurrently.

Renesas demonstrations have the following requirements.

- The firmware must be able to collect all measurements and transmit them over the USB.
- The USB methodology (speed and type of pipe/endpoints) should be able to accommodate the transmission and reception of all measurements.
- The GUI must be able to collect and display the information while other Windows applications are open.

### 7.5.1 Using the Export Data to Analyze the Measurement Speed of an Installation

You can perform empirical speed measurements with the Export Data function. See the Firmware Count column in [Figure 8](#).

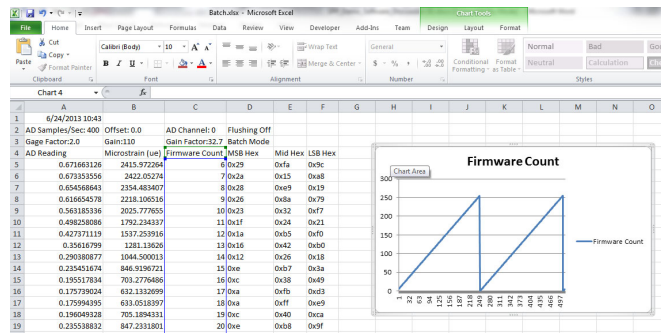

Figure 8. Sawtooth When Plotting Firmware Count

If all readings are being collected, then the values in the column count from 0 to 255, roll over to zero, and start over. If you plot this column, the graph should yield a perfect sawtooth waveform when all measurements are being collected.

### 7.5.2 Measuring Batch Mode Throughput

Developer tests on various installations indicate all measurements can be collected in “Batch” mode at up to 400Sps (Samples per Second). However, this value can vary between installations. As seen in [Figure 8](#), the exported data should yield a sawtooth waveform in the Firmware Count column.

### 7.5.3 Real-Time Graph Options and Flushing

With real-time graphing, it is possible to record all measurements if the Sample Rate is slow enough to accommodate graphing and USB throughput overhead. Therefore, a Flush On/Flush Off selection is available in the **ADC Options** menu.

[Figure 9](#) is a screen shot of a low frequency periodic ramp ADC Reading and the Firmware Count. The figure shows that a waveform can reproduce accurately even with real-time graphing if that flushing is off.

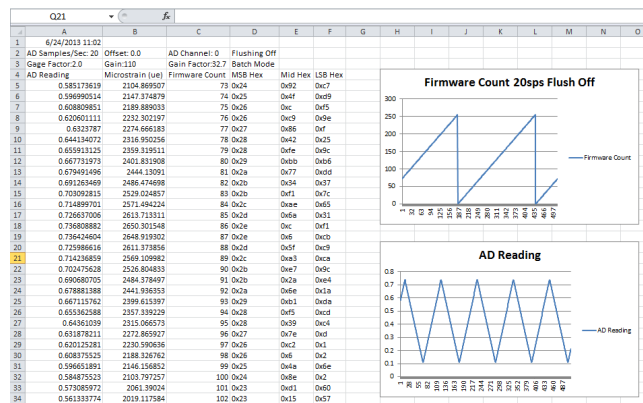

Figure 9. Low Frequency Real-Time Graph with Flushing Off

However, if flushing is on, measurements are skipped arbitrarily. [Figure 10 on page 17](#) shows the same waveform and sample rate with flushing on. With flushing on, [Figure 8](#) shows that the Firmware Count has missing values, and the collected waveform appears more jagged in the figure.



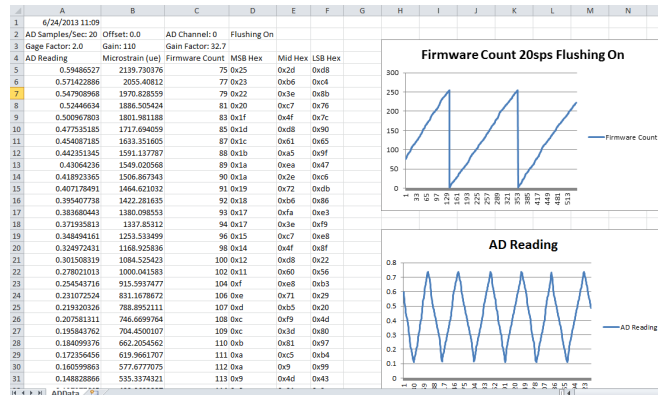

Figure 10. Low Frequency Real-time Graph with Flushing On

### 7.5.4 Typical Throughput at 80sps

If you view the Firmware Count waveform at the default 80Sps, you can also see the effects of the Flush On and Flush Off modes.

With Flush On at 80Sps, about every third measurement is collected. This yields a smoother sawtooth; however, again about every third measurement is actually collected. In [Figure 9 on page 16](#), running at 80Sps with real-time graphing, about every third measurement is collected.

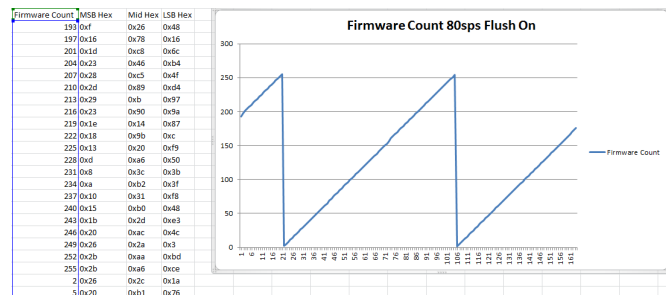

Figure 11. Real-Time Graph, 80Sps, Flushing On

With flushing off at 80Sps, you get more continuous samples; however, large gaps occur when the USB buffer fills up and flushing is arbitrated by the USB driver.

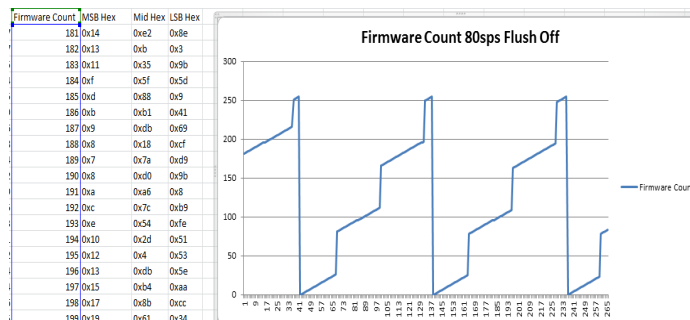

Figure 12. Real-Time Graph, 80Sps, Flushing Off

[Figure 12](#) shows that running at 80Sps, with real-time graphing and flushing off yields more continuous measurements, with larger gaps when USB buffers overflow.

When running at 80Sps, with real-time graphing and flushing off, more continuous measurements are displayed with larger gaps when USB buffers overflow.

### 7.5.5 Throughput Summary

- You can observe measurement throughput of an installation by examining the Firmware Count column in the exported data.
- Batch mode should be capable of collecting continuous measurements up to 400Sps. However, this value may be lower based on specific installation factors.
- The **Flush On/Flush Off** selection can force real-time updates. **Flush On** works better at higher sample rates and **Flush Off** works better with lower sample rates. Again, results may vary by installation.

## 8. Design Considerations

### 8.1 ISL28634

The ISL28634 is an ideal choice for the input amplifier for a strain gauge design. The 5V zero-drift rail-to-rail input/output programmable gain instrumentation amplifier has the following features: low offset, low noise, low gain error, and high CMRR. The zero drift circuitry achieves low offset and gain error drifting. The logic interface allows up to nine selectable gain settings. The differential output amplifier includes a reference pin to set the common-mode output voltage to interface with differential input ADC.

### 8.2 ISL28233 Dual Micropower, Zero-Drift, RRIO Operational Amplifier

The ISL28233 is a dual micropower, zero-drift operational amplifier (op amp) that is optimized for single supply operation from 1.65V to 5.5V. The low supply current of 18 $\mu$ A and wide input range enable the ISL28233 to be an excellent general purpose op amp for a variety of applications.

### 8.3 ISL26104 24-Bit ADC

The ISL26104 is a complete analog front-end with quad differential multiplexed inputs for high resolution measurements. The ISL26104 features a third order modulator providing up to 21.4-bit noise-free performance (10Sps). The 24-Bit delta-sigma Analog-to-Digital Converter (ADC) includes a very low-noise amplifier with programmable gain. Although this application demonstration uses an input buffer amplifier (ISL28634), the high input impedance of the ISL26104 allows direct connection of sensors such as load cell bridges to ensure the specified measurement accuracy without a buffer amplifier. To initiate a correct power-up reset, diode D<sub>1</sub>, resistor R<sub>3</sub>, and capacitor C<sub>8</sub> implement a simple RC delay to ensure the  $\overline{\text{PDWN}}$  transitions from low-to-high after both power supplies settle to specified levels.

### 8.4 ISL21010 (3.3V) Voltage Reference

The ISL21010CFH333 is a precision 3.3V, low dropout micropower band-gap voltage reference, which provides a  $\pm 0.2\%$  accurate reference. The ISL21010 provides up to 25mA output current sourcing with low 150mV dropout voltage. The low supply current and low dropout voltage combined with high accuracy make the ISL21010 ideal for precision low powered applications.

### 8.5 ISL21010 (4.096V) Voltage Reference

The ISL21010CFH341 is a precision 4.096V, low dropout micropower band-gap voltage reference, which provides a  $\pm 0.2\%$  accurate reference. The ISL21010 provides up to 25mA output current sourcing with low 150mV dropout voltage. The low supply current and low dropout voltage combined with high accuracy make the ISL21010 ideal for precision low powered applications.

### 8.6 ISL43840 Low-Voltage, Dual 4-to-1 Multiplexer

The ISL43840 is a precision, bidirectional, analog switch configured as a dual 4-channel multiplexer (mux)/demultiplexer. In this design, the mux is configured as a differential mux. The mux is designed to operate from a single +2V to +12V supply or from a  $\pm 2\text{V}$  to  $\pm 6\text{V}$  supply. The ISL43840 has low charge injection with 1pC (maximum) at  $V_S = \pm 5\text{V}$ .

### 8.7 ISL23328 Volatile, 128 Tap, I<sup>2</sup>C Digital Potentiometer

The ISL23328 has a VLOGIC pin allowing operation down to 1.2V on the bus, independent from the VCC value. This feature allows for low logic levels to be connected directly to the ISL23328 without passing through a voltage level shifter.

## 8.8 Bill of Materials

Part Number	Ref Des	Qty	Value	Tol.	Voltage	Power	Package Type	JEDEC Type	Mfr	Description
Generic	C1, C6,C25	3	0.01 $\mu$ F	10%	16V		402	CAP_0402	Various	Multilayer Cap
Generic	C2, C5, C14, C16-C20, C22, C23, C27-C32	16	0.1 $\mu$ F	10%	16V		402	CAP_0402	Various	Multilayer Cap
Generic	C3, C11, C12, C26	4	1 $\mu$ F	20%	16V		603	CAP_0603	Various	Ceramic Cap
Generic	C4	1	10 $\mu$ F	10%	16V		1206	CAP_1206	Various	Multilayer Cap
GRM21BR71C475KA73L	C7	1	4.7 $\mu$ F	10%	16V		805	CAP_0805	Murata	Ceramic Cap
Generic	C8	1	2.2 $\mu$ F	10%	16V		805	CAP_0805	Various	Multilayer Cap
Generic	C9, C13	2	10pF	10%	50V		402	CAP_0402	Various	Multilayer Cap
Generic	C15	1	0.33 $\mu$ F	10%	25V		603	CAP_0603	Various	Multilayer Cap
C0805C106K8PACTU	C21	1	10 $\mu$ F	10%	10V		805	CAP_0805	Kemet	Multilayer Cap
BAT54	D1	1					Single	SOT23	Diodes	30V Schottky Diode
MMSD4148T1	D2, D4-D6	4					SOD123	SOD123	ON-Semi	Switching Diode
597-3311-407	D3	1					SMD	DIA_LED1206	Dialight	Surface Mount Green LED
48037-1000	J1	1					MOLEX1	CON_USB_MOLEX_480371000	Molex	Right Angle USB A-Type Receptacle
PPPC062LJBN-RC	J2	1					DIP	CONN12	Sullins	12 Pin Header 2.54mmx2.54mm (0.100) Connector RA
PAD_50	P1, P2	2					THOLE	PAD-50	Various	0.050 Pad with 0.031 Plated Thru Hole
Generic	R1, R6, R11	3	0	0%		1/16W	402	RES_0402	Various	Thick Film Chip Resistor
Generic	R2, R7	2	100	1%		1/16W	402	RES_0402	Various	Thick Film Chip Resistor
Generic	R3	1	1k	1%		1/16W	402	RES_0402	Various	Thick Film Chip Resistor
Generic	R8, R9, R28, R29	4	10k	1%		1/16W	402	RES_0402	Various	Thick Film Chip Resistor
Generic	R10	1	221	1%		1/16W	402	RES_0402	Various	Thick Film Chip Resistor
Generic	R12, R13, RC16, RC18, R20	5	4.99k	1%		1/16W	402	RES_0402	Various	Thick Film Chip Resistor
Generic	R4, R5, R14, R15	4	49.9	1%		1/16W	402	RES_0402	Various	Thick Film Chip Resistor
Generic	R16, R22, R25	3	249	0.1%		1/10W	805	RES_0805	Various	Thick Film Chip Resistor

Part Number	Ref Des	Qty	Value	Tol.	Voltage	Power	Package Type	JEDEC Type	Mfr	Description
MCR03EZPFX3001	R17	1	3k	1%		1/10W	603	RES_0603	Rohm	Metal Film Chip Resistor
Generic	R18, R23, R26	3	100	0.1%		1/10W	805	RES_0805	Various	Thick Film Chip Resistor
Generic	R19, R24, R27	3	1	1.0%		1/10W	805	RES_0805	Various	Thick Film Chip Resistor
251206102Y1	L1	1	1 $\mu$ H				SMD	SM1206	Fair-Rite	Ferrite Bead
ISL23328TFRUZ	U1	1					QFN	UTQFN16_102X71_157	Renesas	16 Lead TQFN Package
ISL21010CFH341Z	U2	1					SOT	SOT23-3	Renesas	3 Pin SOT23-3 Package
ISL28233FRZ	U3	1					DFN3X3E P	DFN8_118X118_256_EP2	Renesas	8 Pin DFN 3x3 0.5 Pitch
ISL28634	U4	1					TSSOP	TSSOP14_173_256	Renesas	14 Pin 173 Mil TSSOP Package
ISL43840IRZ	U5	1					QFN	QFN20_157X157_197_EP	Renesas	20 Lead Quad Flat Package (Pb-Free)
ISL21090BFB825Z	U6	1					SOIC	SOIC8	Renesas	8 Pin 157 Mil Body SOIC Package
R5F10JBCANA	U7	1					QFN-S	QFN32_197X197_197_EPA	Renesas	32 Lead Quad Flat Package (Pb-Free)
IP4220CZ6	U8	1					SOT457	SOT457	NXP	Dual USB 2.0 Integrated ESD Protection
ISL21010CFH333Z	U9	1					SOT	SOT23-3	Renesas	3 Pin SOT23-3 Package
ISL26104AVZ	U10	1					28P	TSSOP28_173_256	Renesas	28 Pin 0.65mm Pitch 4.4mmx9.7mm TSSOP Package
ISL54054IRVZ	U11	1					1_2X1A	UTDFN6_47X39_157_A	Renesas	6 Pin UTDFN-1.2x1A.4 Pitch Package
NX5032GA-12.000M-LNCD-1	Y1	1					SM	XTAL_NX5032GA	NDK	12.000MHz SM Crystal

### 8.9 RTKA-BDGSTKEV1Z Evaluation Board Layout

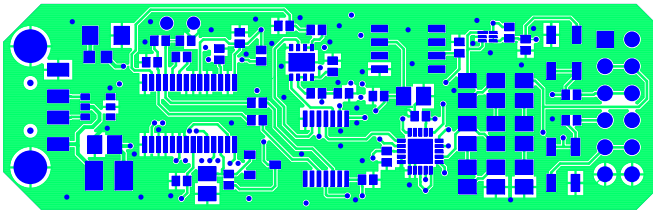

Figure 13. Top Layer

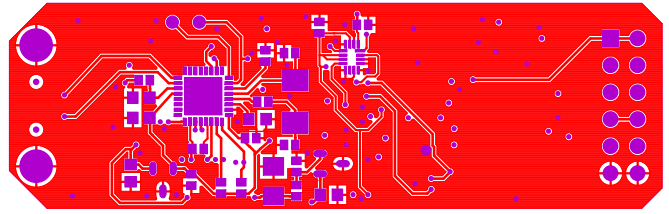

Figure 14. Bottom Layer

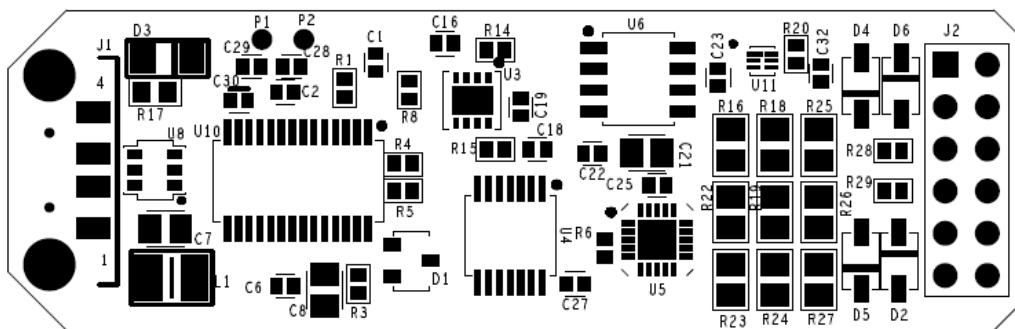

Figure 15. Top Assembly Drawing

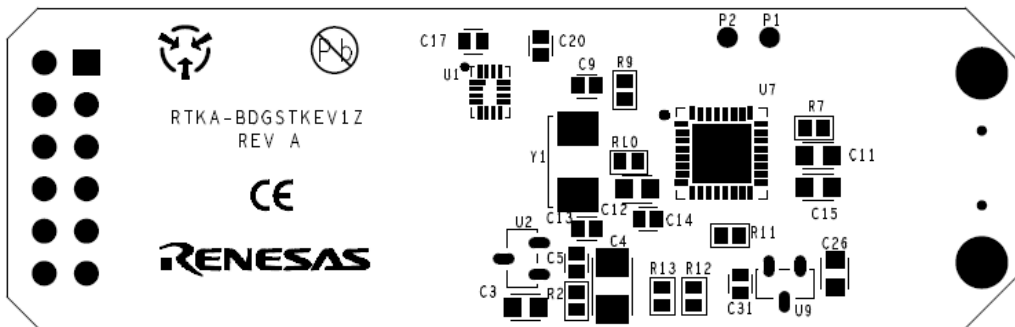

Figure 16. Bottom Assembly Drawing

### 8.10 RTKA-BDGSTKEV1Z Schematic

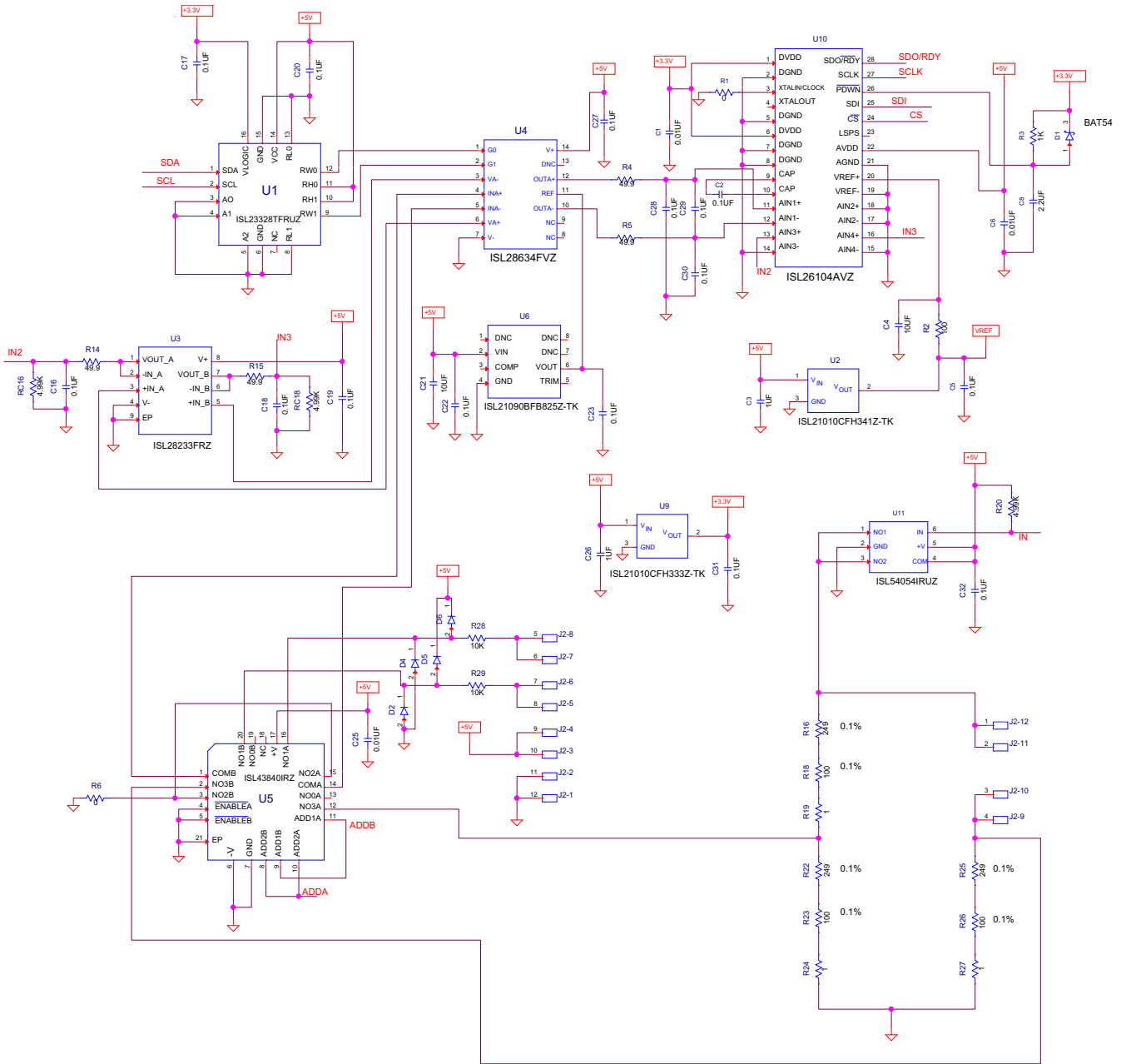
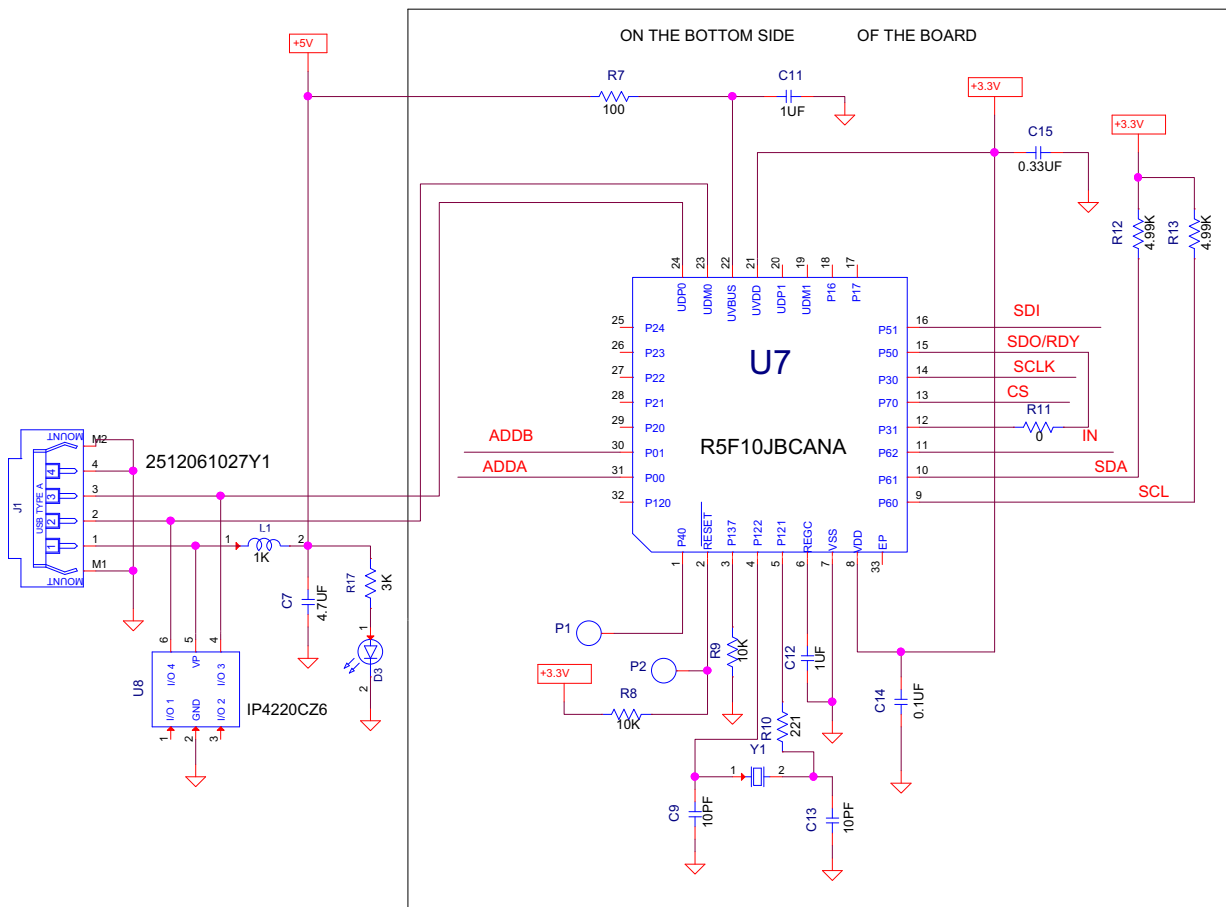

Figure 17. RTKA-BDGSTKEV1Z Strain Gauge Schematic



# RTKA-BDGSTKEV1Z

REV A

01/07/2019

Figure 18. IRTKA-BDGSTKEV1Z MCU Schematic



## 9. Revision History

Rev.	Date	Description
2.00	Jul.10.19	Updated Bill of Materials
1.01	Jun.5.19	Updated ISL21010 information.
1.00	Apr.9.19	Initial release.

## Notice

1. Descriptions of circuits, software and other related information in this document are provided only to illustrate the operation of semiconductor products and application examples. You are fully responsible for the incorporation or any other use of the circuits, software, and information in the design of your product or system. Renesas Electronics disclaims any and all liability for any losses and damages incurred by you or third parties arising from the use of these circuits, software, or information.
2. Renesas Electronics hereby expressly disclaims any warranties against and liability for infringement or any other claims involving patents, copyrights, or other intellectual property rights of third parties, by or arising from the use of Renesas Electronics products or technical information described in this document, including but not limited to, the product data, drawings, charts, programs, algorithms, and application examples.
3. No license, express, implied or otherwise, is granted hereby under any patents, copyrights or other intellectual property rights of Renesas Electronics or others.
4. You shall not alter, modify, copy, or reverse engineer any Renesas Electronics product, whether in whole or in part. Renesas Electronics disclaims any and all liability for any losses or damages incurred by you or third parties arising from such alteration, modification, copying or reverse engineering.
5. Renesas Electronics products are classified according to the following two quality grades: "Standard" and "High Quality". The intended applications for each Renesas Electronics product depends on the product's quality grade, as indicated below.
  - "Standard": Computers; office equipment; communications equipment; test and measurement equipment; audio and visual equipment; home electronic appliances; machine tools; personal electronic equipment; industrial robots; etc.
  - "High Quality": Transportation equipment (automobiles, trains, ships, etc.); traffic control (traffic lights); large-scale communication equipment; key financial terminal systems; safety control equipment; etc.Unless expressly designated as a high reliability product or a product for harsh environments in a Renesas Electronics data sheet or other Renesas Electronics document, Renesas Electronics products are not intended or authorized for use in products or systems that may pose a direct threat to human life or bodily injury (artificial life support devices or systems; surgical implantations; etc.), or may cause serious property damage (space system; undersea repeaters; nuclear power control systems; aircraft control systems; key plant systems; military equipment; etc.). Renesas Electronics disclaims any and all liability for any damages or losses incurred by you or any third parties arising from the use of any Renesas Electronics product that is inconsistent with any Renesas Electronics data sheet, user's manual or other Renesas Electronics document.
6. When using Renesas Electronics products, refer to the latest product information (data sheets, user's manuals, application notes, "General Notes for Handling and Using Semiconductor Devices" in the reliability handbook, etc.), and ensure that usage conditions are within the ranges specified by Renesas Electronics with respect to maximum ratings, operating power supply voltage range, heat dissipation characteristics, installation, etc. Renesas Electronics disclaims any and all liability for any malfunctions, failure or accident arising out of the use of Renesas Electronics products outside of such specified ranges.
7. Although Renesas Electronics endeavors to improve the quality and reliability of Renesas Electronics products, semiconductor products have specific characteristics, such as the occurrence of failure at a certain rate and malfunctions under certain use conditions. Unless designated as a high reliability product or a product for harsh environments in a Renesas Electronics data sheet or other Renesas Electronics document, Renesas Electronics products are not subject to radiation resistance design. You are responsible for implementing safety measures to guard against the possibility of bodily injury, injury or damage caused by fire, and/or danger to the public in the event of a failure or malfunction of Renesas Electronics products, such as safety design for hardware and software, including but not limited to redundancy, fire control and malfunction prevention, appropriate treatment for aging degradation or any other appropriate measures. Because the evaluation of microcomputer software alone is very difficult and impractical, you are responsible for evaluating the safety of the final products or systems manufactured by you.
8. Please contact a Renesas Electronics sales office for details as to environmental matters such as the environmental compatibility of each Renesas Electronics product. You are responsible for carefully and sufficiently investigating applicable laws and regulations that regulate the inclusion or use of controlled substances, including without limitation, the EU RoHS Directive, and using Renesas Electronics products in compliance with all these applicable laws and regulations. Renesas Electronics disclaims any and all liability for damages or losses occurring as a result of your noncompliance with applicable laws and regulations.
9. Renesas Electronics products and technologies shall not be used for or incorporated into any products or systems whose manufacture, use, or sale is prohibited under any applicable domestic or foreign laws or regulations. You shall comply with any applicable export control laws and regulations promulgated and administered by the governments of any countries asserting jurisdiction over the parties or transactions.
10. It is the responsibility of the buyer or distributor of Renesas Electronics products, or any other party who distributes, disposes of, or otherwise sells or transfers the product to a third party, to notify such third party in advance of the contents and conditions set forth in this document.
11. This document shall not be reprinted, reproduced or duplicated in any form, in whole or in part, without prior written consent of Renesas Electronics.
12. Please contact a Renesas Electronics sales office if you have any questions regarding the information contained in this document or Renesas Electronics products.

(Note1) "Renesas Electronics" as used in this document means Renesas Electronics Corporation and also includes its directly or indirectly controlled subsidiaries.

(Note2) "Renesas Electronics product(s)" means any product developed or manufactured by or for Renesas Electronics.

(Rev.4.0-1 November 2017)

## Corporate Headquarters

TOYOSU FORESIA, 3-2-24 Toyosu,  
Koto-ku, Tokyo 135-0061, Japan  
[www.renesas.com](http://www.renesas.com)

## Contact Information

For further information on a product, technology, the most up-to-date version of a document, or your nearest sales office, please visit:  
[www.renesas.com/contact/](http://www.renesas.com/contact/)

## Trademarks

Renesas and the Renesas logo are trademarks of Renesas Electronics Corporation. All trademarks and registered trademarks are the property of their respective owners.

RTKA-BDGSTKEV1Z