

RTKA212831DR0000BU

The RTKA212831DR0000BU provides a simple platform to demonstrate the performances of the [RAA212831](#). The RAA212831 is an integrated 72V input voltage, 0.5A output load one synchronous buck regulator with fixed switching frequency from 350kHz and two 100mA, and 50mA output load linear regulators LDOs. The buck can support a wide input voltage range of 14V to 72V and adjusted output voltage from 1.25V to  $V_{IN} \times D_{max}$ . The LDO\_3V3 can support a wide input voltage range of 6V to 12V, and the output voltage is fixed at 3.3V. The LDO\_5 can support a wide input voltage range of 6V to 12V, and the output voltage is fixed at 5V. It is designed for small size and high integration electric-bike control board power management. Integrated buck and LDOs minimize the system components.

The Buck converter adopts peak current mode control, providing 500mA current for load and downstream LDO regulators, while the following LDOs provide 5V and 3.3V regulated power sources to the system. The current-mode buck converter provides a fast transient response and cycle-by-cycle switching current limit. All output voltages are fixed internally with few external components.

The RAA212831 has a fixed frequency operation, even the output terminal is light load condition, therefore, the switching frequency is fixed during the load variation. The RAA212831 can also use external components to achieve standby function to control buck output voltage as 6V or 12V. When the chip wants to save more energy with LDOs operations only, the external component can control buck output voltage from 12V to 6V.

Features

- Buck Converter:
  - 4.5V to 72V input voltage
  - Adjustable output voltage from 1.25V to  $V_{IN} \times D_{max}$
  - 500mA output load capability
  - $0.6\Omega$  high-side MOSEFT  $r_{DS(ON)}$
  - Fixed switching frequency 350kHz operation
  - High side OCP, UVP, UVLO, OTP fault protection
- 5V LDO Regulator:
  - 6V to 12V input voltage
  - Fixed output voltage 5V
  - 100mA output load capability
  - Current limit foldback function
- 3.3V LDO Regulator:
  - 6V to 12V input voltage
  - Fixed output voltage 3.3V
  - 50mA output load capability
  - Current limit foldback function

Specifications

This board is configured and optimized for the following operating conditions:

- $V_{IN} = 14V$  to  $72V$  (For  $V_{OUT}$  is operated at  $6V \sim 12V$ )
- $V_{OUT} = 6V \sim 12V$  (For LDOs normal operations)
- $I_{OUT\_MAX} = 0.5A$
- $V_{LDO\_5V} = 5V$
- $LDO\_5V\_MAX = 0.1A$
- $V_{LDO\_3V3} = 3.3V$
- $ILDO\_3V3\_MAX = 0.05A$

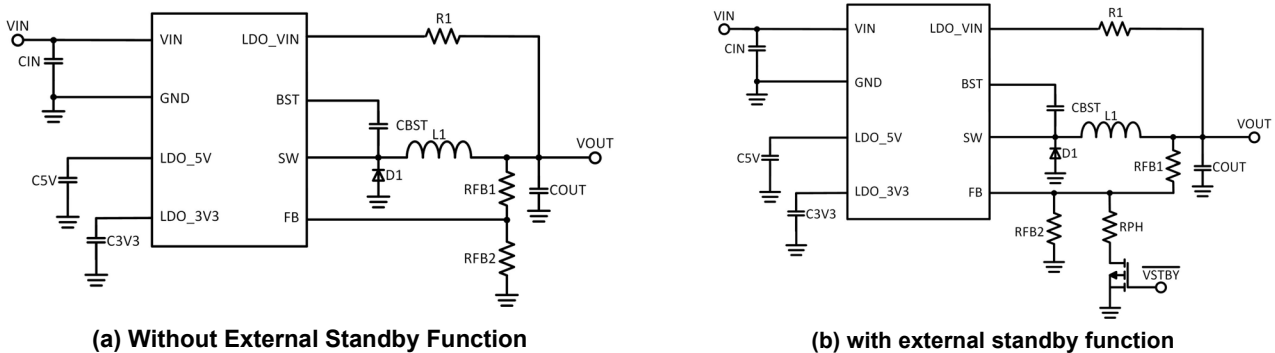

Figure 1. Typical Application Diagrams

## Contents

<b>1. Functional Description</b>	<b>3</b>
1.1 Operation Range	3
1.2 Setup and Configuration	3
<b>2. Board Design</b>	<b>4</b>
2.1 Layout Guidelines	4
2.2 Schematic Diagram	5
2.3 Bill of Materials	6
2.4 Board Layout	7
<b>3. Typical Performance Graphs</b>	<b>8</b>
<b>4. Ordering Information</b>	<b>12</b>
<b>5. Revision History</b>	<b>12</b>

# 1. Functional Description

The RTKA212831DR0000BU demonstration board provides a simple platform to demonstrate the features of the RAA212831. The RTKA212831DR0000BU has a functionally optimized RAA212831 circuit layout that allows efficient operation up to the maximum output current.

The RTKA212831DR0000BU demonstration board is shown in Figure 3 and Figure 4. Figure 5 shows the schematic. The bill of materials and PCB layout information are also provided for your reference. Figure 8 through Figure 31 show performance data taken using this hardware.

## 1.1 Operation Range

The RTKA212831DR0000BU demonstration board input voltage range is 14V to 72V. The output voltage is fixed at 12V when the EXTFB test point is high and 6V when the EXTFB test point is low. It is a simple setting for use. For the LDO\_5V rail, the output voltage is 5V (default) with a 100mA maximum output current. For the LDO\_3V3 rail, the output voltage is 3.3V (default) with a 50mA maximum output current.

## 1.2 Setup and Configuration

See Figure 2 and complete the following steps:

1. Connect the power supply to the input terminals VIN (J1) and GND (J6). Connect the load to the output terminals, VOUT (J3) and GND (T2). Connect the load to the LDO\_5V output terminals, LDO\_5V (J2) and GND(J8). Connect the load to the LDO\_3V3 output terminals, LDO\_3V3 (J2) and GND (J8).
2. Ensure the setup is correctly connected before applying any power or load to the board.
3. Turn on the power supply and the part should start operating.
4. Verify that the buck output voltage is 12V with the EXTFB test point high, and phase node waveforms can be monitored at TP1. Verify that the LDO\_5V output voltage is 5V and the LDO\_3V3 output voltage is 3.3V.

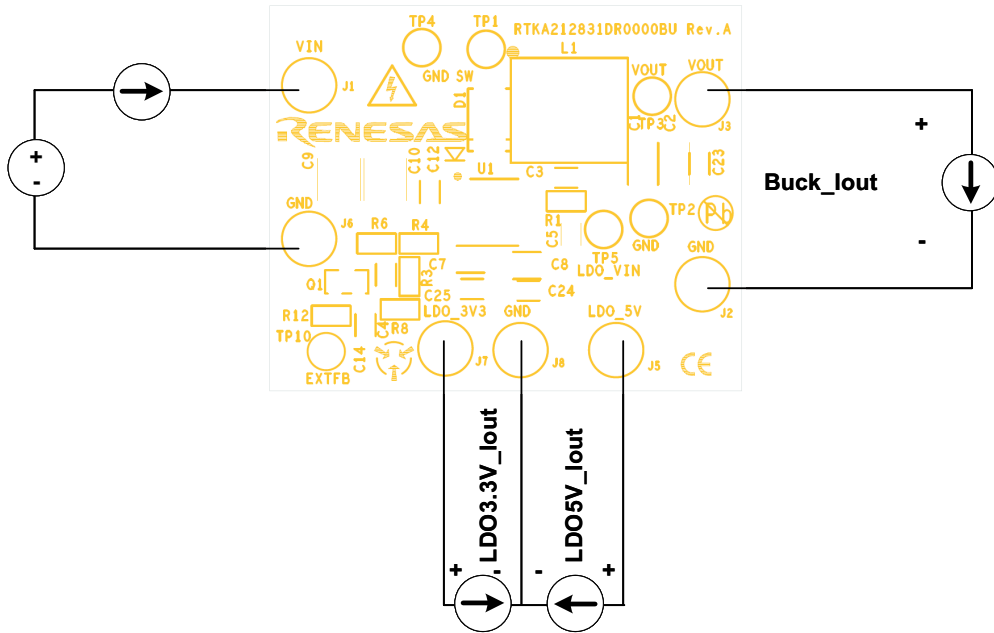

Figure 2. RTKA212831DR0000BU Board Setup

## 2. Board Design

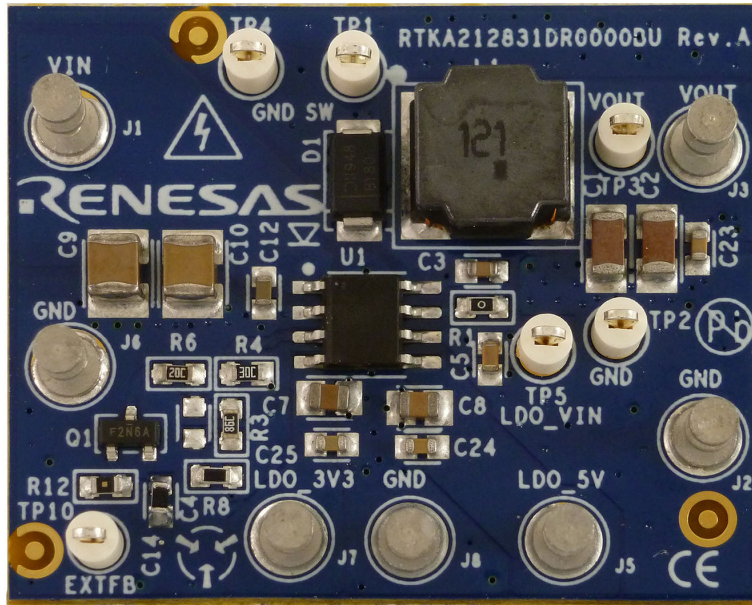

Figure 3. RTKA212831DR0000BU Demonstration Board (Top)



Figure 4. RTKA212831DR0000BU Demonstration Board (Bottom)

### 2.1 Layout Guidelines

A good PCB layout is important to achieve expected performance. Consideration should be taken when placing the components and routing the trace to minimize the ground impedance and keep the parasitic inductance low. The input and output capacitors should have a good ground connection and be placed as close to the IC as possible. Place the LDO\_VIN pin trace away from noisy planes and traces. The via pattern under the RAA212831 is connected to a large ground copper plane on the bottom layer for effective thermal dissipation.

## 2.2 Schematic Diagram

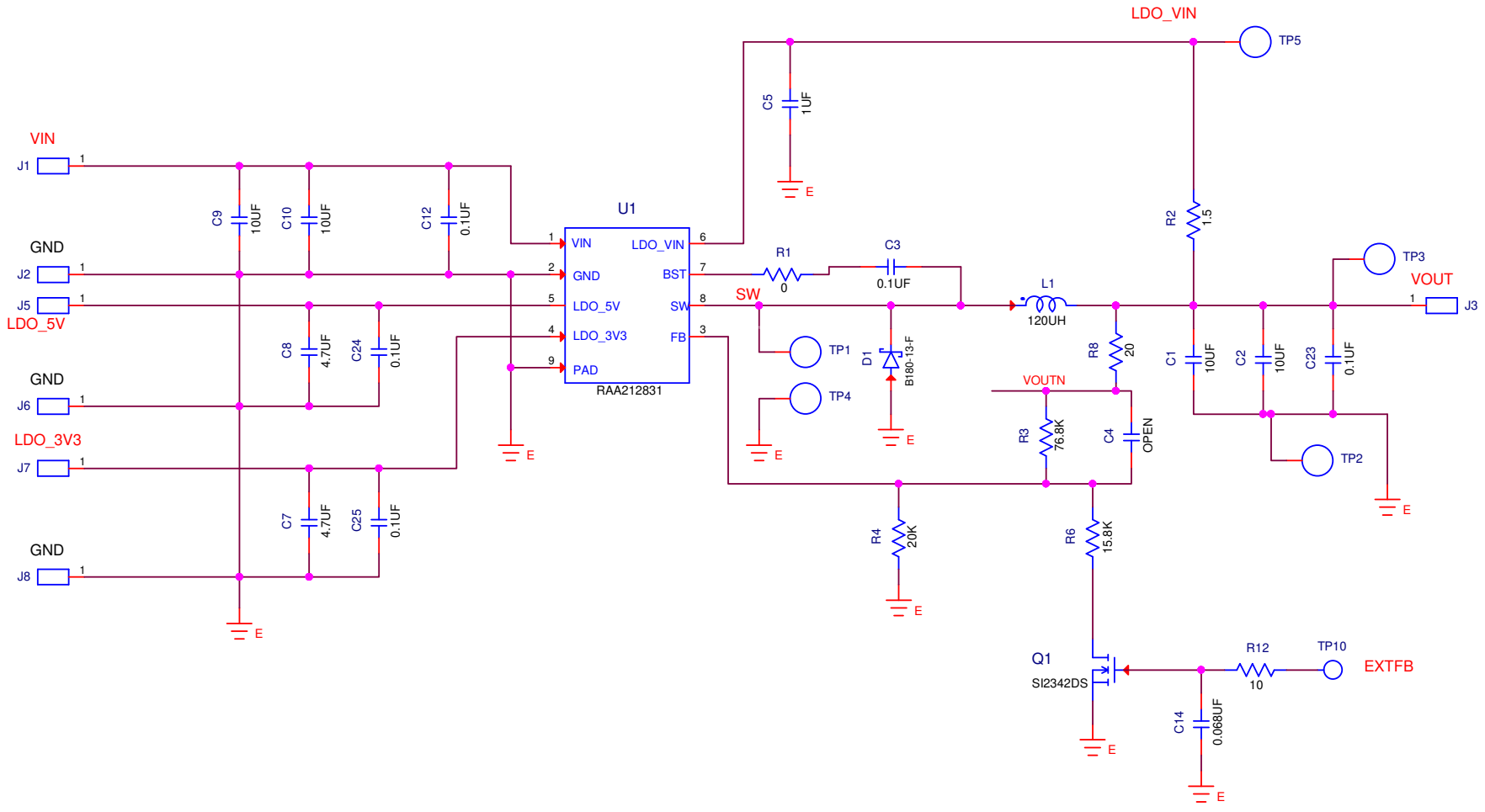

Figure 5. RTKA212831DR0000BU Board Circuit Schematic

## 2.3 Bill of Materials

Qty	Ref Des	Description	Manufacturer	Part Number
1	U1	IC SWITCHING REGULATOR, 8P, PSOP-8E, ROHS	Renesas	RAA212831GSP#AA0
1	L1	COIL PWR INDUCTOR, SM, 8mm, 120µH, 20%, 1.15A, ROHS	Würth	74404084121
1	D1	1A 80V SCHOTTKY BARRIER RECTIFIER	Diodes	B180-13-F
1	Q1	6A, 8V, N-Channel (D-S) MOSFET	Vishay	SI2342DS
2	C1, C2	CAP, SMD, 1206, 10µF, 35V, 10%, X7R, ROHS	TDK	CGA5L1X7R1V106K160AC
4	C3, C23-C25	CAP, SMD, 0603, 0.1µF, 16V, 10%, X7R, ROHS	Murata	GCM188R71C104KA37D
2	C7, C8	CAP, SMD, 0805, 4.7µF, 10V, 10%, X7R, ROHS	Murata	GRM21BR71A475KA73
1	C5	CAP, SMD, 0603, 1µF, 25V, 10%, X7R, ROHS	Murata	GCM188R71E105KA64D
2	C9, C10	CAP, SMD, 1210, 10µF, 100V, 10%, X7S, ROHS	Murata	GRM32EC72A106KE05L
1	C12	CAP, SMD, 0603, 0.1µF, 100V, 10%, X7R, ROHS	Murata	GRM188R72A104KA35J
1	C14	CAP, SMD, 0603, 0.068µF, 25V, 10%, X7R, ROHS	Kemet	C0603C683K3RACTU
1	R2	RES, SMD, 0603, 1.5Ω, 1/10W, 1%, ROHS	Various	Generic
1	R1	RES, SMD, 0603, 0Ω, 1/10W, 1%, ROHS	Various	Generic
1	R12	RES, SMD, 0603, 10Ω, 1/10W, 1%, ROHS	Various	Generic
1	R6	RES, SMD, 0603, 15.8kΩ, 1/10W, 1%, ROHS	Various	Generic
1	R4	RES, SMD, 0603, 20kΩ, 1/10W, 1%, ROHS	Various	Generic
1	R3	RES, SMD, 0603, 76.8kΩ, 1/10W, 1%, ROHS	Various	Generic
1	R8	RES, SMD, 0603, 20Ω, 1/10W, 1%, ROHS	Various	Generic
6	TP1-TP6	CONN MINI TEST POINT, VERTICAL, WHITE, ROHS	Keystone	5002
7	J1-J3, J5-J8	CONN DBL TURRET, TH, 0.218x0.078 PCB MNT, TIN/BRASS, ROHS	Keystone	1502-2



## 2.4 Board Layout

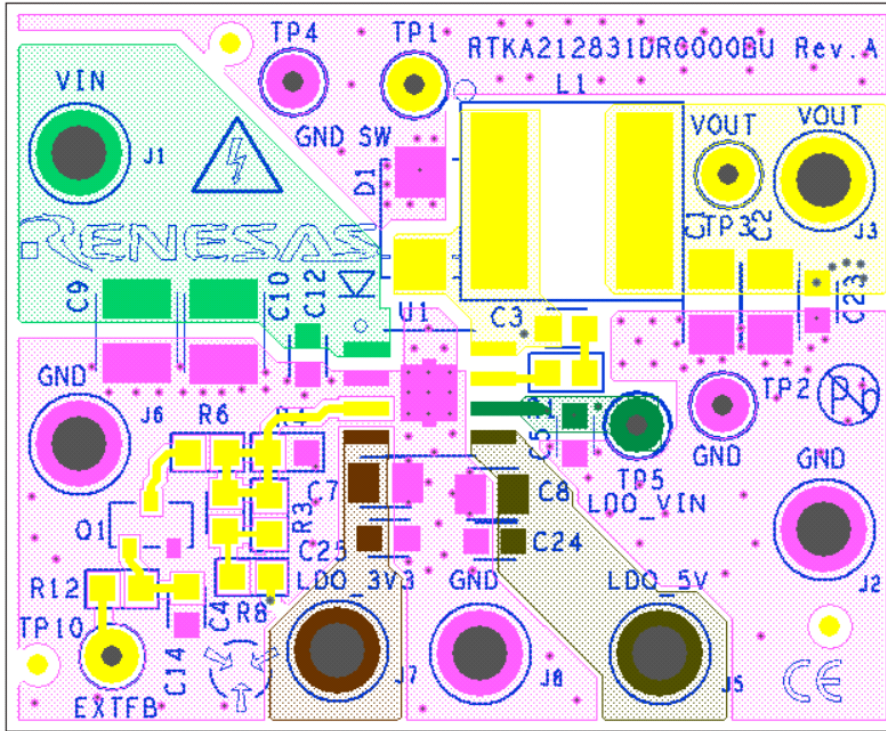

Figure 6. Top Layer

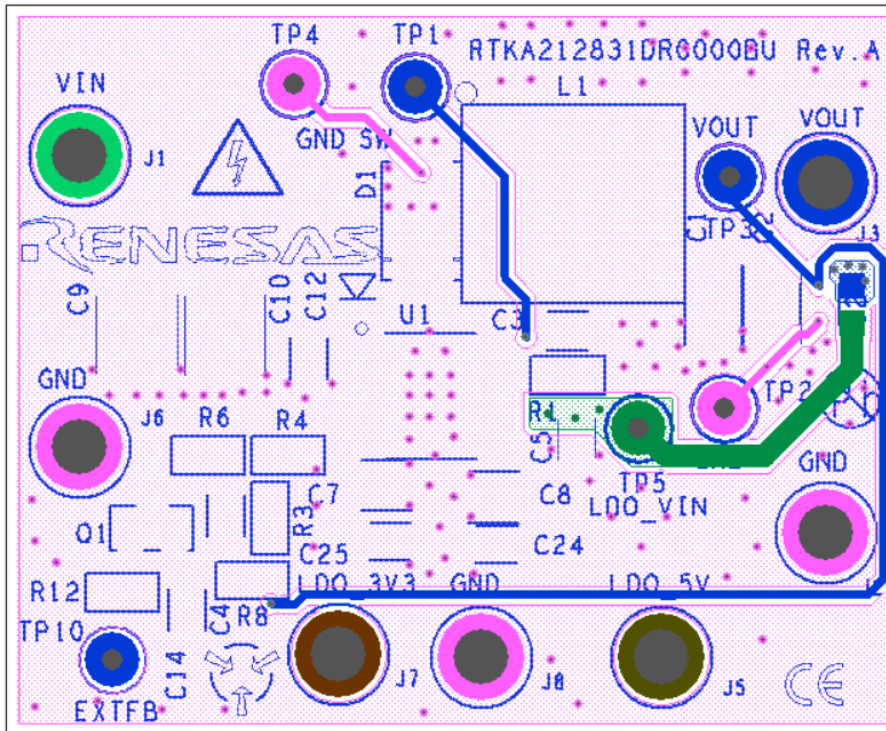

Figure 7. Bottom Layer

### 3. Typical Performance Graphs

$V_{IN} = 56V$ ,  $V_{OUT} = 6V$ ,  $T_A = +25^{\circ}C$ , unless otherwise noted.

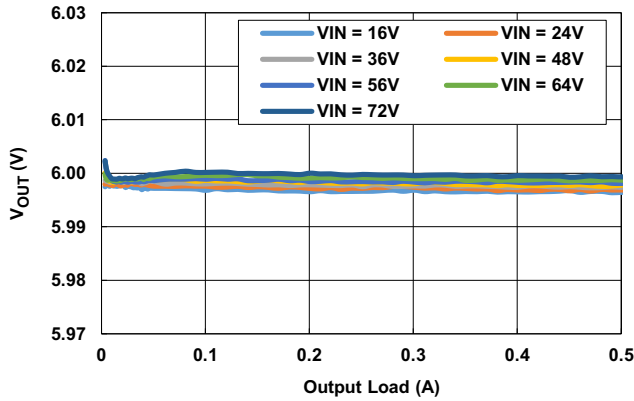

Figure 8. Load Regulation

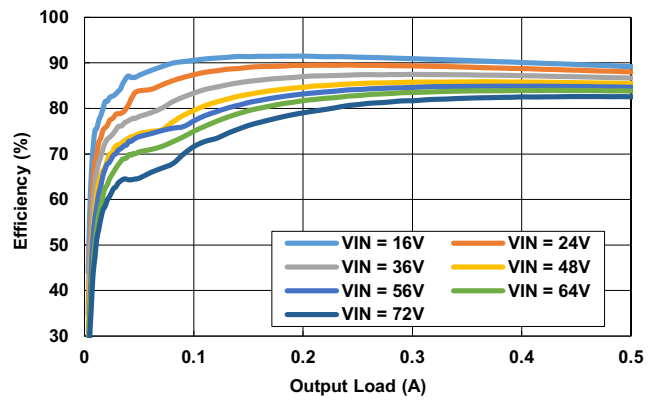

Figure 9. Efficiency

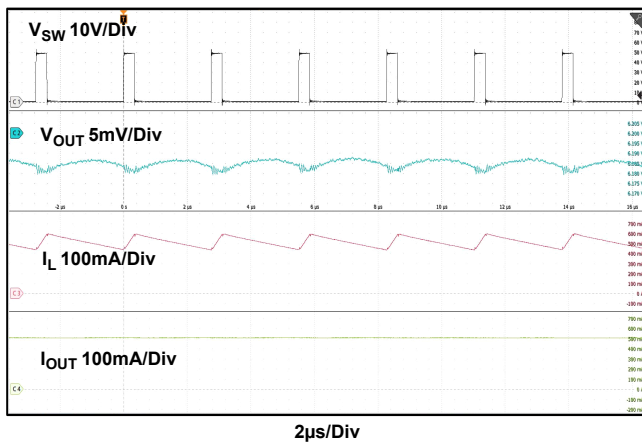

Figure 10. Buck Output Ripple at Full Load

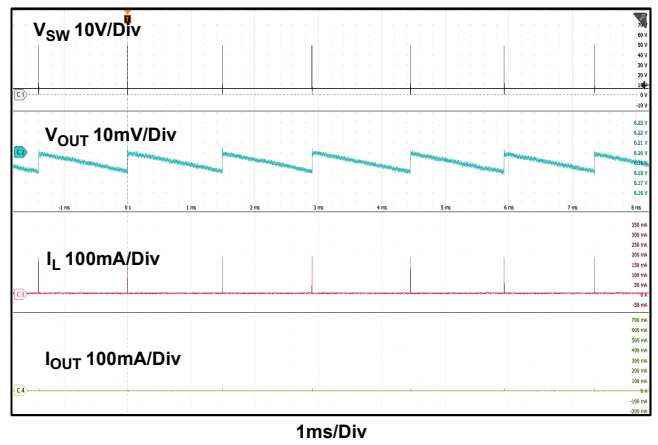

Figure 11. Buck Output Ripple at No Load

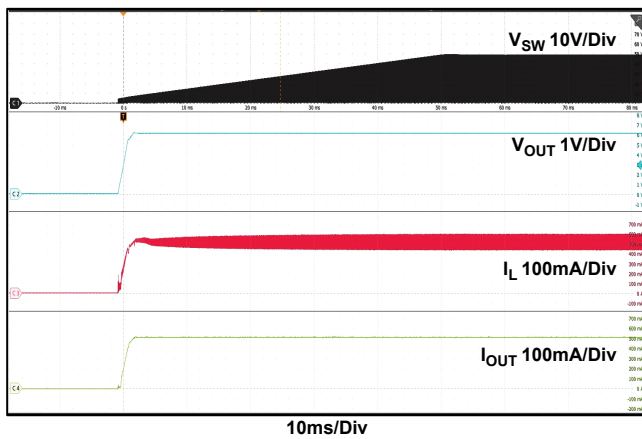

Figure 12. Power-On at Full Load

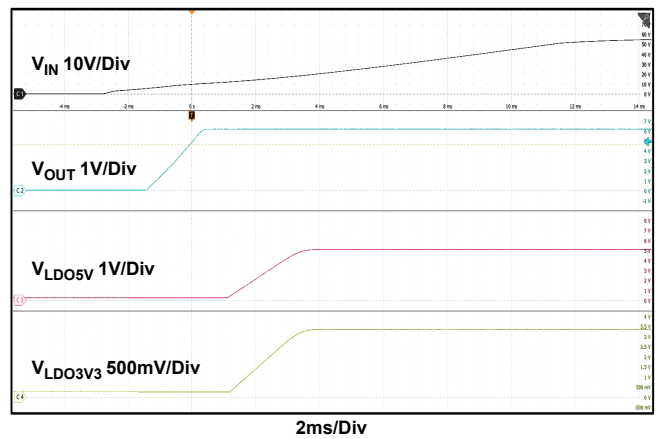

Figure 13. Power-On at Full Load with LDO Channels



$V_{IN} = 56V$ ,  $V_{OUT} = 6V$ ,  $T_A = +25^{\circ}C$ , unless otherwise noted.

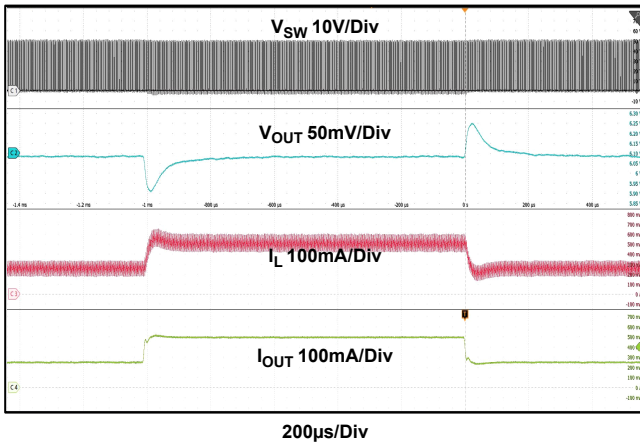

Figure 14. Load Transient between 0.25A to 0.5A

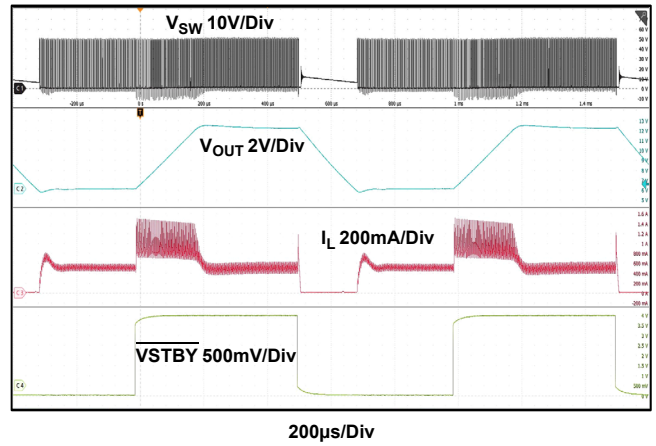

Figure 15. With External Standby Function at Full Load

$V_{IN} = 56V$ ,  $V_{OUT} = 12V$ ,  $T_A = +25^{\circ}C$ , unless otherwise noted.

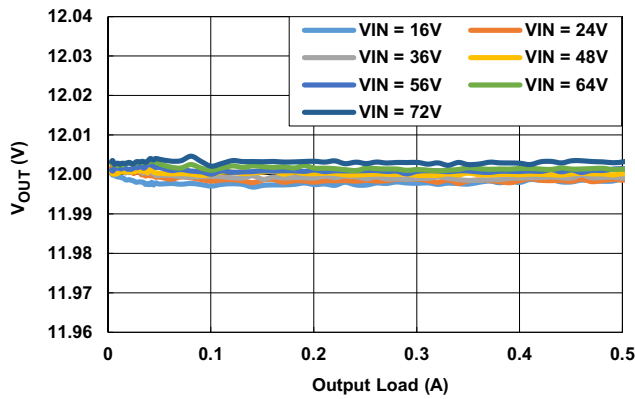

Figure 16. Load Regulation

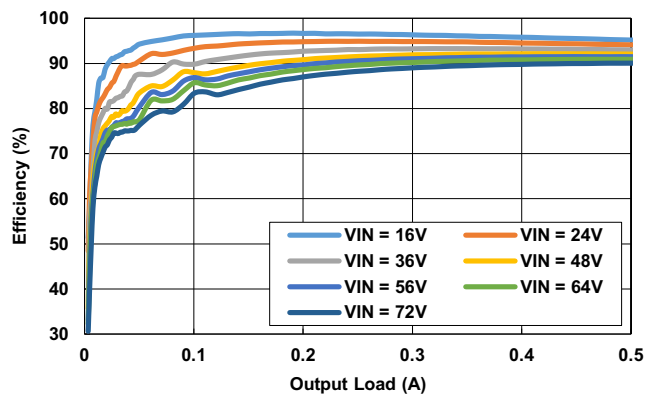

Figure 17. Efficiency

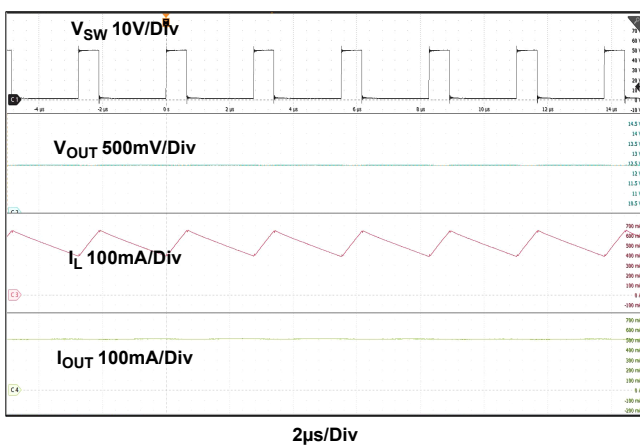

Figure 18. Buck Output Ripple at Full Load

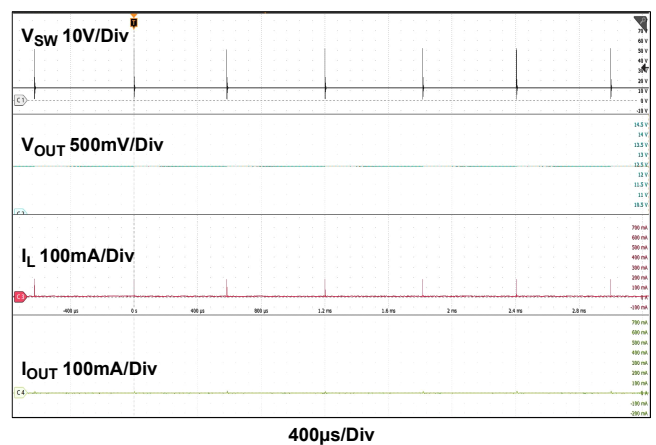

Figure 19. Buck Output Ripple at No Load

$V_{IN} = 56V$ ,  $V_{OUT} = 12V$ ,  $T_A = +25^{\circ}C$ , unless otherwise noted.

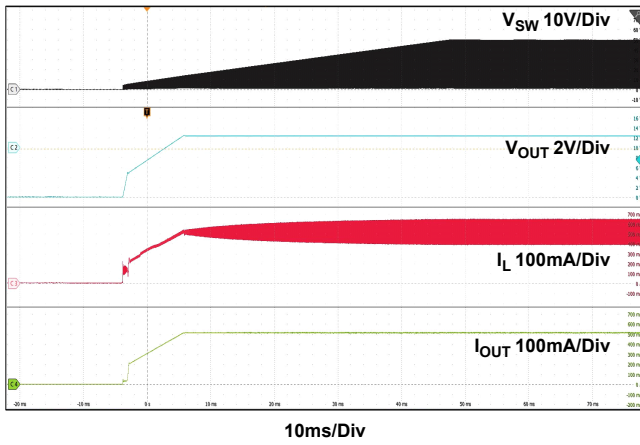

Figure 20. Power-On at Full Load

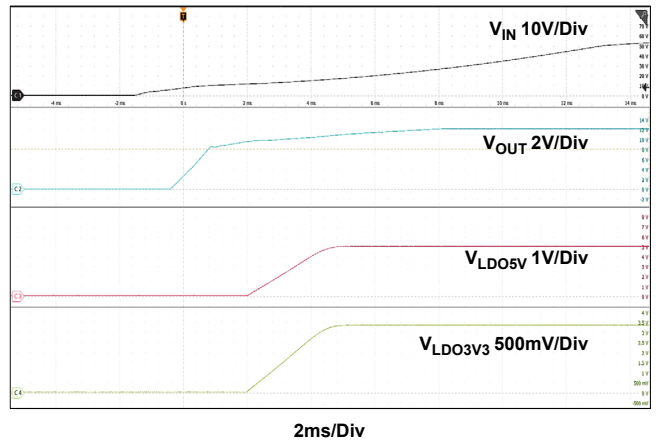

Figure 21. Power-On at Full Load with LDO Channels

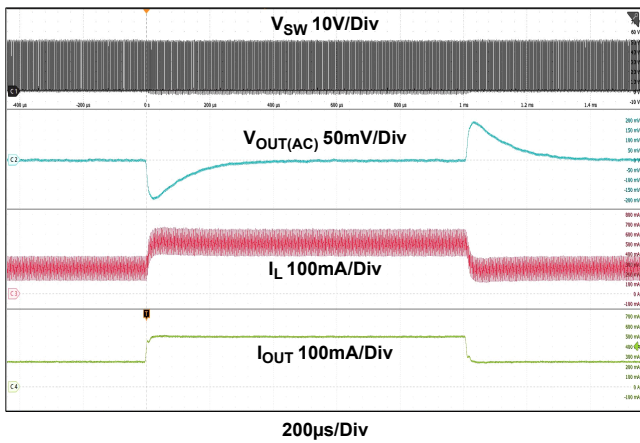

Figure 22. Load Transient between 0.25A to 0.5A

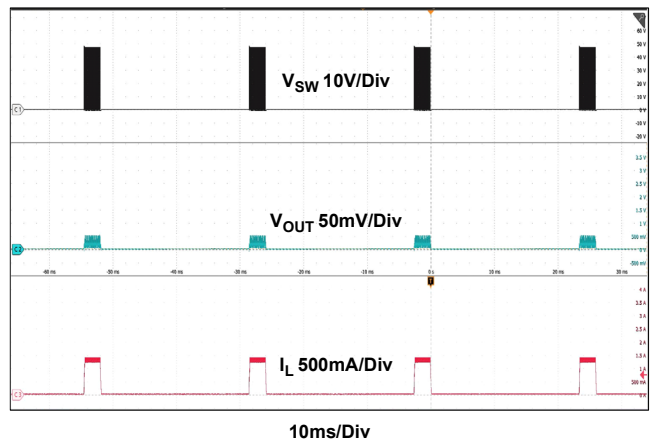

Figure 23. UVP Fault with Hiccup Operation

$V_{OUT} = V_{INLDO} = 6V$ ,  $V_{LDO5V} = 5V$ ,  $V_{LDO3V3} = 3.3V$ ,  $T_A = +25^{\circ}C$ , unless otherwise noted.

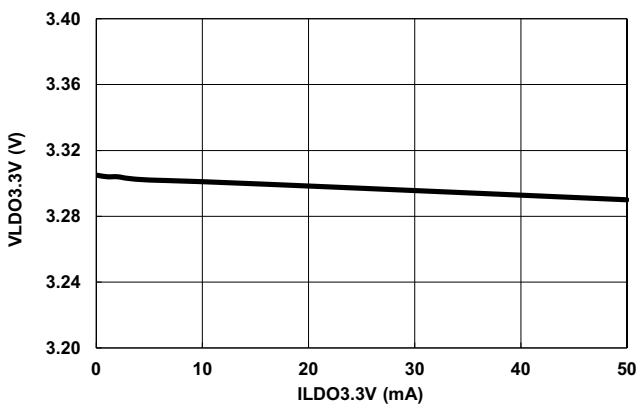

Figure 24. VLDO3V3 Load Regulation

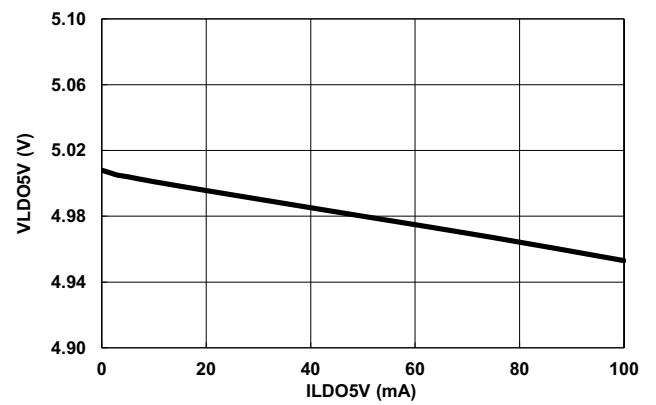

Figure 25. VLDO5V Load Regulation

$V_{OUT} = V_{INLDO} = 6V$ ,  $V_{LDO5V} = 5V$ ,  $V_{LDO3V3} = 3.3V$ ,  $T_A = +25^\circ C$ , unless otherwise noted. (Cont.)

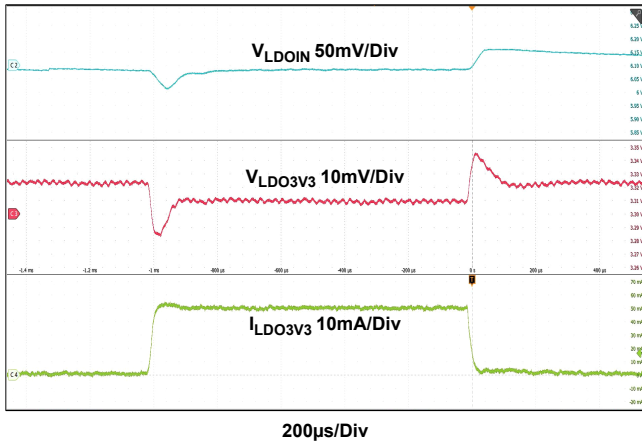

Figure 26. VLDO3V3 Load Transient between 0A to 0.05A

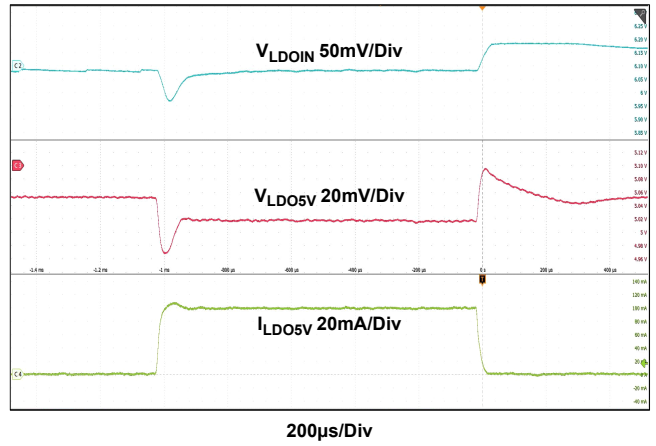

Figure 27. VLDO5V Load Transient between 0A to 0.1A

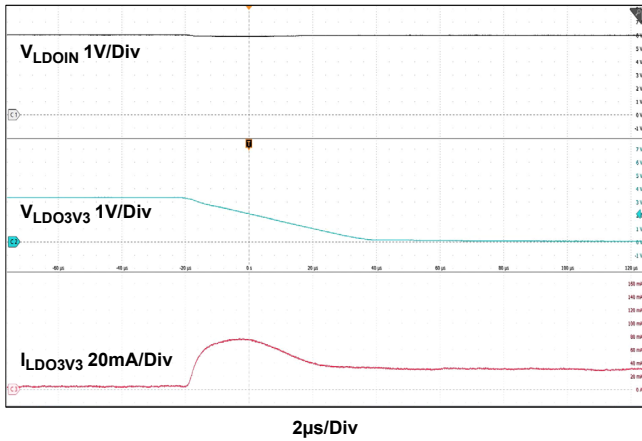

Figure 28. VLDO3V3 OCP Fault with Current Foldback

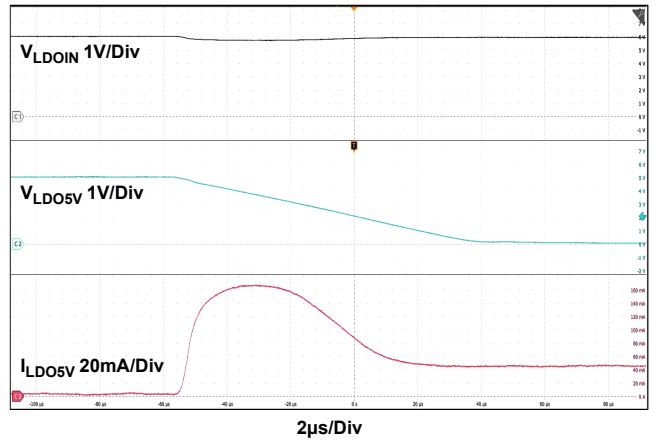

Figure 29. VLDO5V OCP Fault with Current Foldback

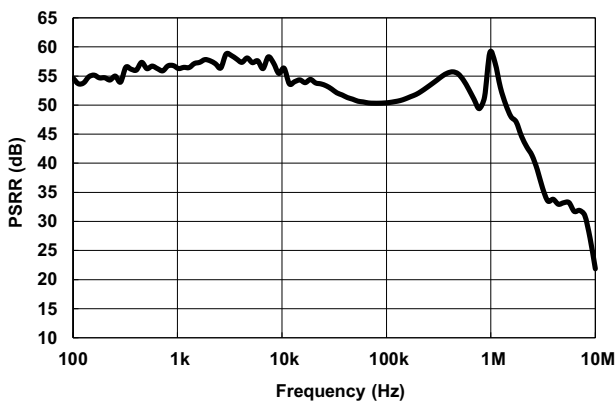

Figure 30. VLDO3V3 PSRR at Full Load

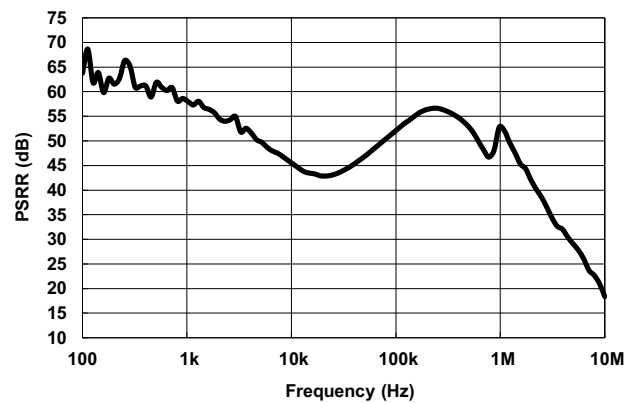

Figure 31. VLDO5V PSRR at Full Load

## 4. Ordering Information

Part Number	Description
RTKA212831DR0000BU	RAA212831 Demonstration Board

## 5. Revision History

Revision	Date	Description
1.02	Mar 2, 2023	Updated output voltage range maximum value.
1.01	Jun 15, 2022	Updated Figures 3 and 4.
1.00	Sep 27, 2021	Initial release

## IMPORTANT NOTICE AND DISCLAIMER

RENESAS ELECTRONICS CORPORATION AND ITS SUBSIDIARIES (“RENESAS”) PROVIDES TECHNICAL SPECIFICATIONS AND RELIABILITY DATA (INCLUDING DATASHEETS), DESIGN RESOURCES (INCLUDING REFERENCE DESIGNS), APPLICATION OR OTHER DESIGN ADVICE, WEB TOOLS, SAFETY INFORMATION, AND OTHER RESOURCES “AS IS” AND WITH ALL FAULTS, AND DISCLAIMS ALL WARRANTIES, EXPRESS OR IMPLIED, INCLUDING, WITHOUT LIMITATION, ANY IMPLIED WARRANTIES OF MERCHANTABILITY, FITNESS FOR A PARTICULAR PURPOSE, OR NON-INFRINGEMENT OF THIRD PARTY INTELLECTUAL PROPERTY RIGHTS.

These resources are intended for developers skilled in the art designing with Renesas products. You are solely responsible for (1) selecting the appropriate products for your application, (2) designing, validating, and testing your application, and (3) ensuring your application meets applicable standards, and any other safety, security, or other requirements. These resources are subject to change without notice. Renesas grants you permission to use these resources only for development of an application that uses Renesas products. Other reproduction or use of these resources is strictly prohibited. No license is granted to any other Renesas intellectual property or to any third party intellectual property. Renesas disclaims responsibility for, and you will fully indemnify Renesas and its representatives against, any claims, damages, costs, losses, or liabilities arising out of your use of these resources. Renesas' products are provided only subject to Renesas' Terms and Conditions of Sale or other applicable terms agreed to in writing. No use of any Renesas resources expands or otherwise alters any applicable warranties or warranty disclaimers for these products.

(Disclaimer Rev.1.0 Mar 2020)

### Corporate Headquarters

TOYOSU FORESIA, 3-2-24 Toyosu,  
Koto-ku, Tokyo 135-0061, Japan  
[www.renesas.com](http://www.renesas.com)

### Contact Information

For further information on a product, technology, the most up-to-date version of a document, or your nearest sales office, please visit:  
[www.renesas.com/contact/](http://www.renesas.com/contact/)

### Trademarks

Renesas and the Renesas logo are trademarks of Renesas Electronics Corporation. All trademarks and registered trademarks are the property of their respective owners.