

RTKA808015DE0020BU

The RTKA808015DE0020BU evaluation board is a 5A synchronous buck regulator with an input range of 2.7V to 5.5V. The board evaluates the performance of the [RAA808015B](#) high-efficiency low BOM count Sync Buck Regulator with 5A output current.

The RAA808015B is offered in a QFN 2x2.5 package with 0.8mm maximum height. The converter occupies 1.516cm² area.

Specifications

This board is optimized for the following operating conditions:

- Input voltage: 2.7V ~ 5.5V_{DC}
- Output voltage: 1.2V_{DC}
- Output current: 5A max
- Output power: 6W
- Efficiency: >80% at 100% load V_{IN} = 5V
- High switching frequency: 2.2MHz
- Load regulation: +/-0.5% at 25°C
- Operating temperature: -40°C to 85°C
- Board dimension: 76.2mmx63.5mm

Key Features

- 2.7V to 5.5V operating input range
- Continuous output current up to 5A
- 20mΩ and 16mΩ internal power MOSFET switches
- Output adjustable from 0.6V
- 100% duty cycle in dropout
- High switching frequency (2.2MHz)
- Fixed Soft Start time
- Cycle-by-cycle overcurrent protection
- OCP and SCP with Hiccup mode
- Input Undervoltage Lockout (UVLO)
- Over-temperature protection
- EN for power sequencing

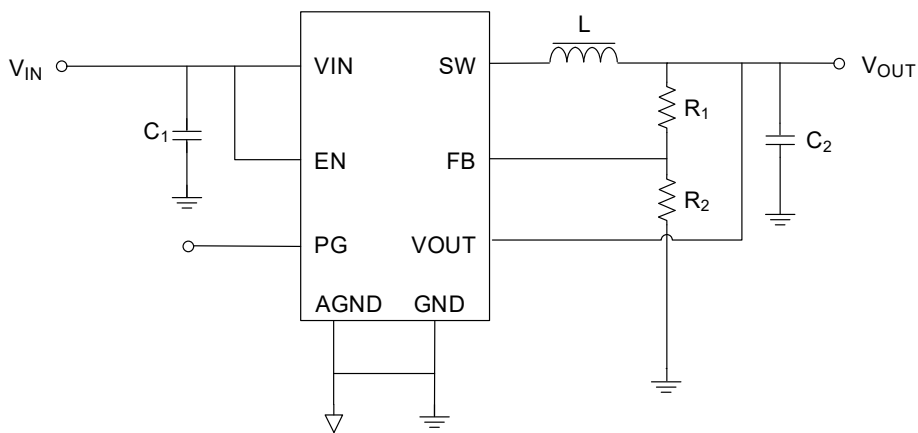

Figure 1. RTKA808015DE0020BU Block Diagram

Contents

1. Functional Description	3
1.1 Recommended Equipment	3
1.2 Quick Start Guide	3
1.2.1 Evaluating the Other Output Voltage	3
2. Board Design	4
2.1 PCB Layout Guidelines	4
2.2 Schematic	5
2.3 Bill of Materials	5
2.4 Board Layout	6
3. Typical Performance Graphs	7
4. Ordering Information	9
5. Revision History	9

1. Functional Description

1.1 Recommended Equipment

The following materials are recommended to perform testing:

- 0V to 6V power supply with at least 20A source current capability
- Electronic loads capable of sinking current up to 15A
- Digital multimeters (DMMs)
- 100MHz quad-trace oscilloscope
- Signal generator

1.2 Quick Start Guide

1. Ensure that the circuit is correctly connected to the supply and loads before applying any power.
2. Connect the bias supply to VIN, the plus terminal to VIN (P4) and the negative return to GND (P5).
3. Turn on the power supply (Recommend $V_{INmax} = <5.5V$).
4. Verify the output voltage is 1.2V for V_{OUT} .

1.2.1 Evaluating the Other Output Voltage

The RTKA808015DE0020BU output is preset to 1.2V; however, output voltages can be adjusted from 0.6V to 3.3V. The output voltage programming resistor, R_2 , depends on the required output voltage of the regulator and the value of the feedback resistor R_1 , as shown in [Equation 1](#).

$$(EQ. 1) \quad R_2 = R_1 \left(\frac{0.6}{V_{OUT} - 0.6} \right)$$

[Table 1](#) shows the component selection that should be used for the respective V_{OUTs} .

Table 1. External Component Selection

V_{OUT} (V)	L_1 (μ H)	C_{OUT} (μ F)	R_1 (k Ω)	R_2 (k Ω)
0.6	0.47	2 x 22	0	300*
1	0.47	2 x 22	200	300
1.2	0.47	2 x 22	200	200
1.8	0.47	2 x 22	200	100
2.5	0.47	2 x 22	200	63.2
3.3	0.47	2 x 22	200	44.2

2. Board Design

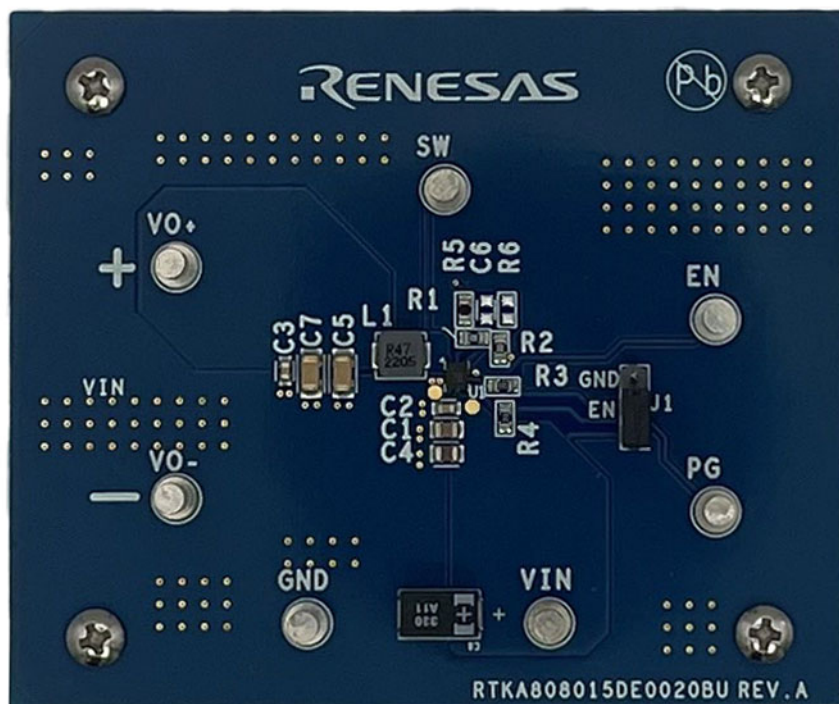

Figure 2. RTKA808015DE0020BU Evaluation Board (Top)

2.1 PCB Layout Guidelines

The following are PCB guidelines to consider when laying out the board.

- Place the input ceramic capacitors between the VIN and GND pins. Place them as close to the pins as possible.
- A 0.1 μ F decoupling input ceramic capacitor is recommended. Place it as close to the VIN pin as possible.
- The GND pin and AGND pin should be tied directly to the power pad under the IC.
- Keep the switching node plane away from the feedback network. Place the resistor divider close to the IC.

2.2 Schematic

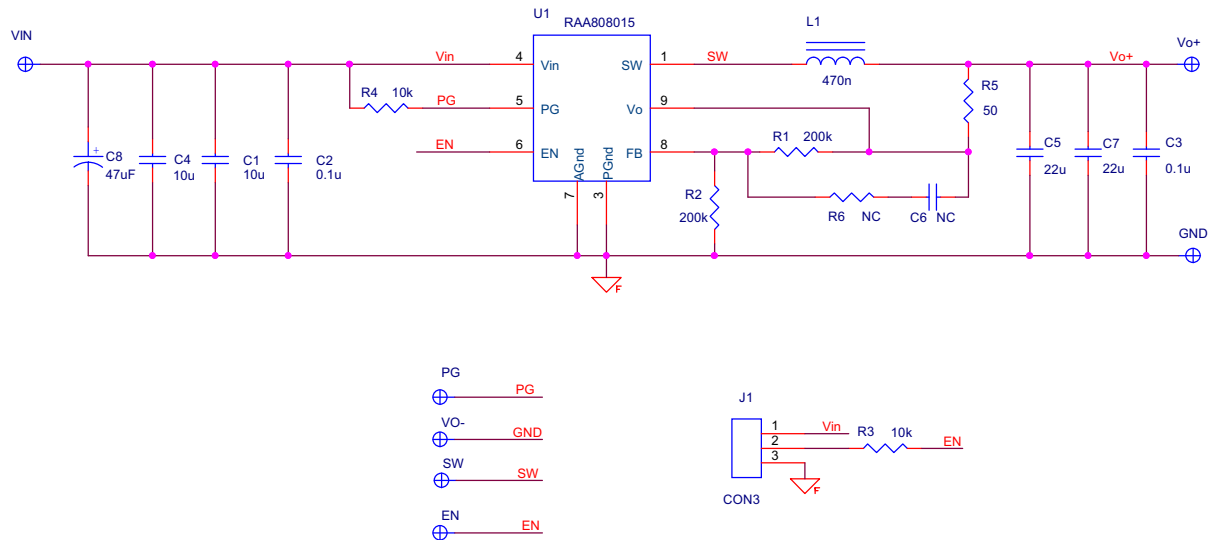

Figure 3. RTKA808015DE0020BU Schematic

2.3 Bill of Materials

Qty	Reference Designator	Description	Manufacturer	Manufacturer Part
1	U1	IC 5A Buck Regulator QFN 2x2.5, ROHS	Renesas	RAA808015BGNP#HA0
2	C1, C4	CAP, SMD, 0805, 10µF, 10V, 10%, X7R, ROHS	TDK Corporation	C2012X7R1A106K125AC
2	C2, C3	CAP, SMD, 0603, 0.1µF, 10V, 10%, X7R, ROHS	AVX Corporation	0603ZC104KAT2A
2	C5, C7	CAP, SMD, 1206, 22µF, 10V, 10%, X7R, ROHS	Murata Electronics	GRM31CR71A226KE15L
1	R1	RES, SMD, 0603, 200k, 1/10W, 1%, TF, ROHS	Yaego	RC0603FR-07200KL
1	R2	RES, SMD, 0603, 200k, 1/10W, 1%, TF, ROHS	Yaego	RC0603FR-07200KL
2	R3, R4	RES SMD 10kΩ 0.1% 1/10W 0603	Yaego	RT0603BRE0710KL
1	R5	RES SMD 50Ω 0.1% 1/10W 0603	Yageo	RT0603BRE0750RL
7	EN, GND, PG, SW, VIN, VO-, VO+	TERM TURRET SINGLE L = 7.14MM TIN, ROHS	Keystone	1514-2
1	J1	CONN-HEADER, 1x3, BREAKAWY 1x36, 2.54mm, ROHS	BERG/FCI	68000-236HLF
1	L1	FIXED IND 470nH 6.8A 14MΩ SMD, ROHS	Würth Elektronik	744373240047
1	C8	47µF Molded Tantalum Polymer Capacitor 10V 1411 (3528 Metric) 70mΩ at 100kHz	Panasonic	10TAB47M

2.4 Board Layout

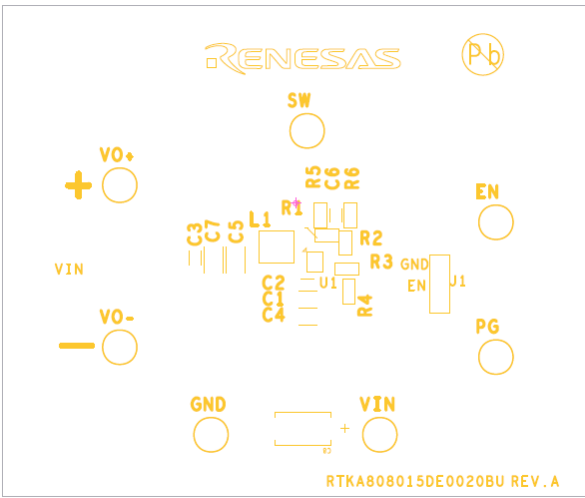

Figure 4. Silkscreen - Top Layer

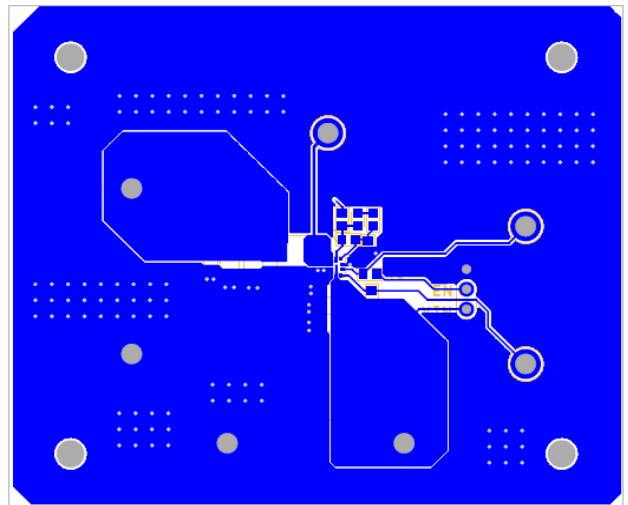

Figure 5. Top Layer

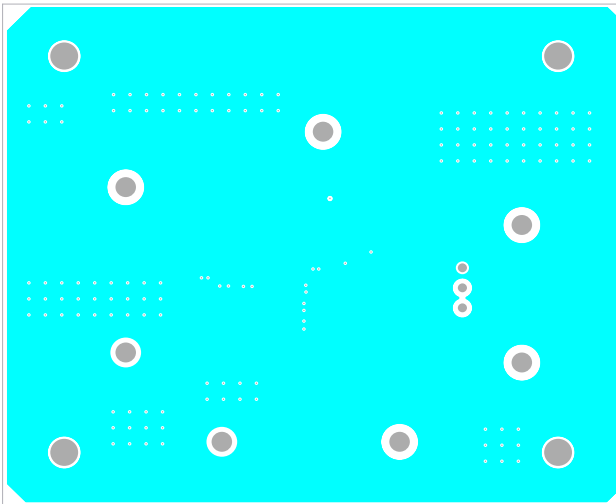

Figure 6. Layer 2

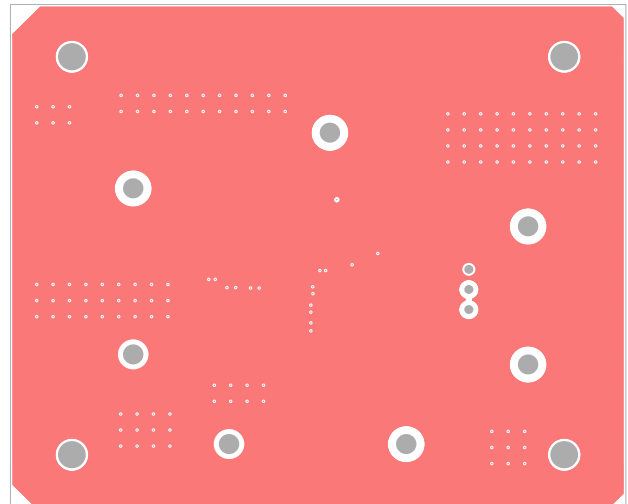

Figure 7. Layer 3

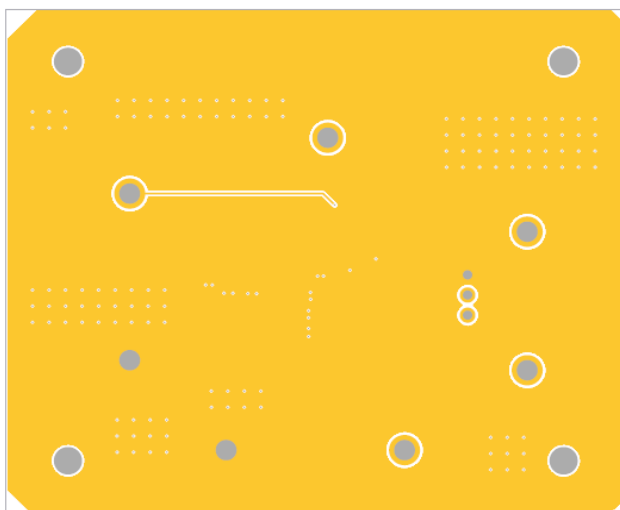

Figure 8. Bottom Layer

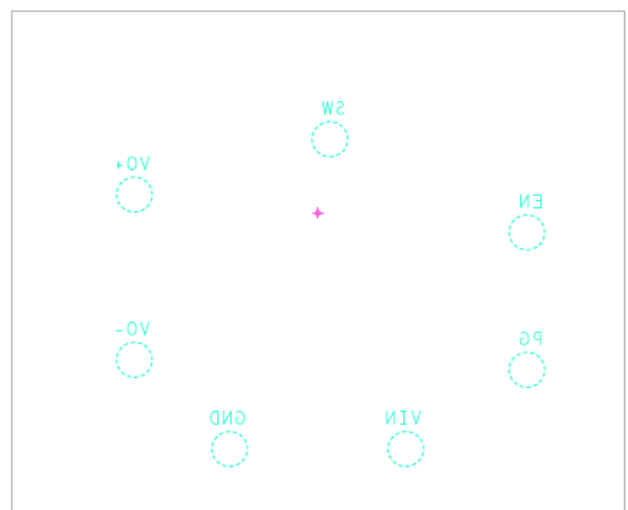

Figure 9. Silkscreen Bottom Layer

3. Typical Performance Graphs

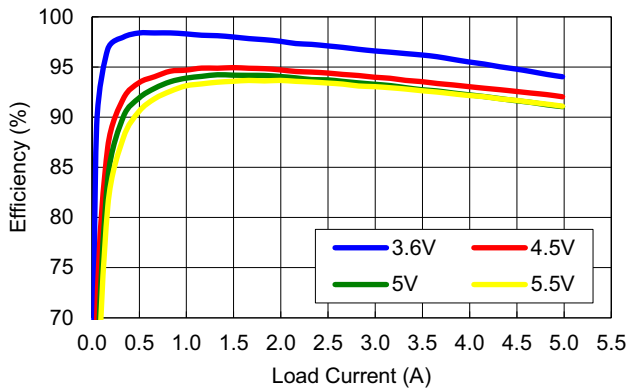

Figure 10. Efficiency vs Load, $V_{OUT} = 3.3V$, $25^{\circ}C$

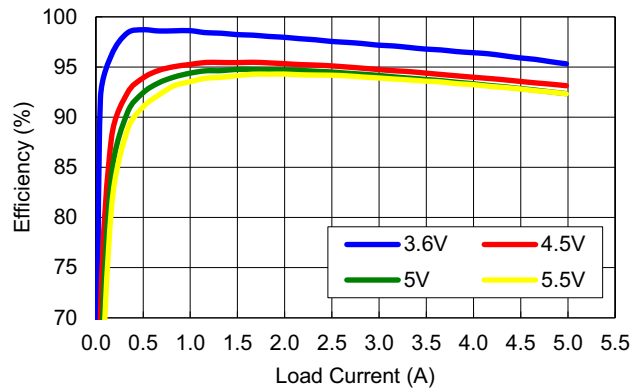

Figure 11. Efficiency vs Load, $V_{OUT} = 3.3V$, $-40^{\circ}C$

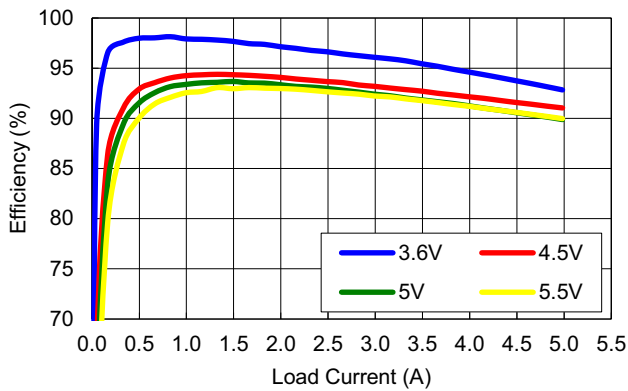

Figure 12. Efficiency vs Load, $V_{OUT} = 3.3V$, $85^{\circ}C$

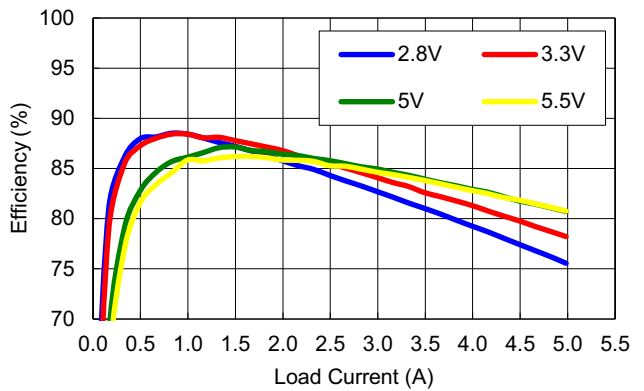

Figure 13. Efficiency vs Load, $V_{OUT} = 1.2V$, $25^{\circ}C$

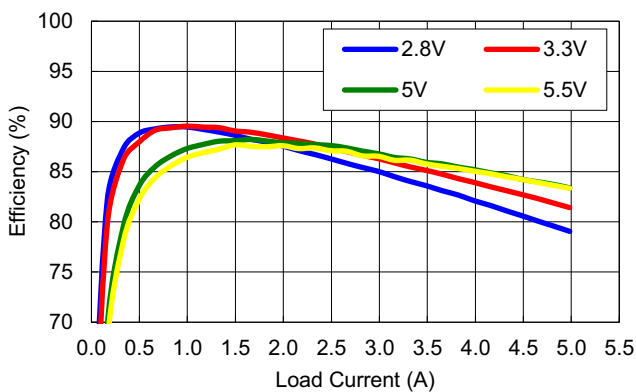

Figure 14. Efficiency vs Load, $V_{OUT} = 1.2V$, $-40^{\circ}C$

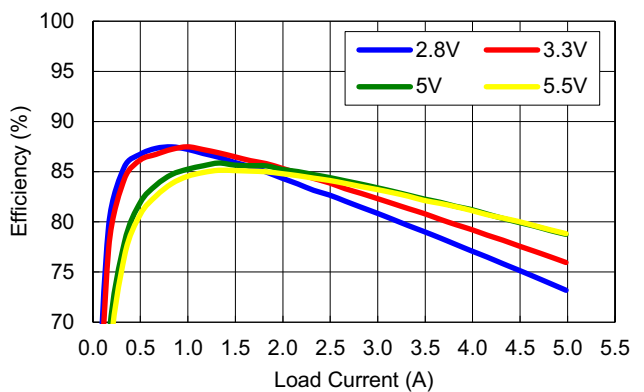

Figure 15. Efficiency vs Load, $V_{OUT} = 1.2V$, $85^{\circ}C$

$V_{IN} = 5V$, $V_{OUT} = 3.3V$, $T_A = +25^{\circ}C$.

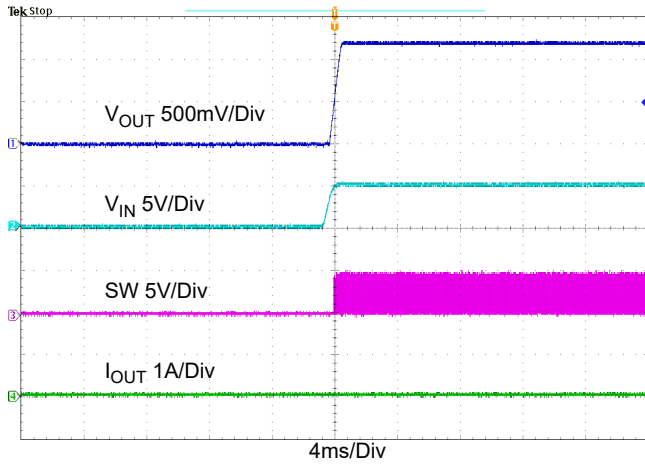

Figure 16. Startup at No Load

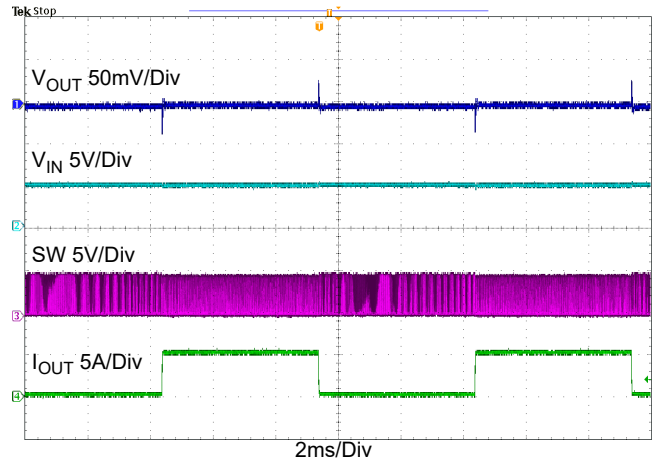

Figure 17. Load Transition, 0A→5A

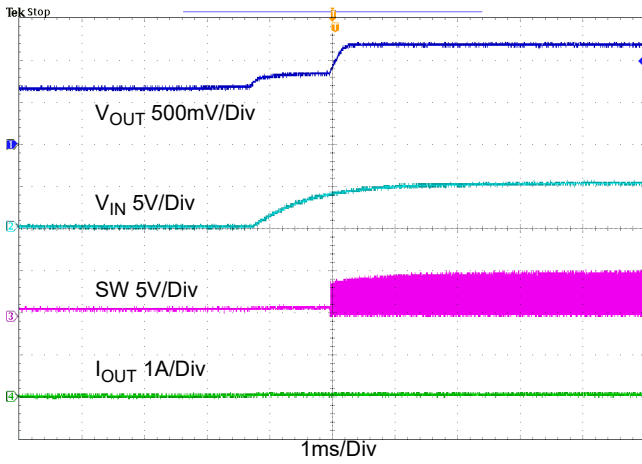

Figure 18. Pre-Bias Startup, $V_{pre} = 0.7V$

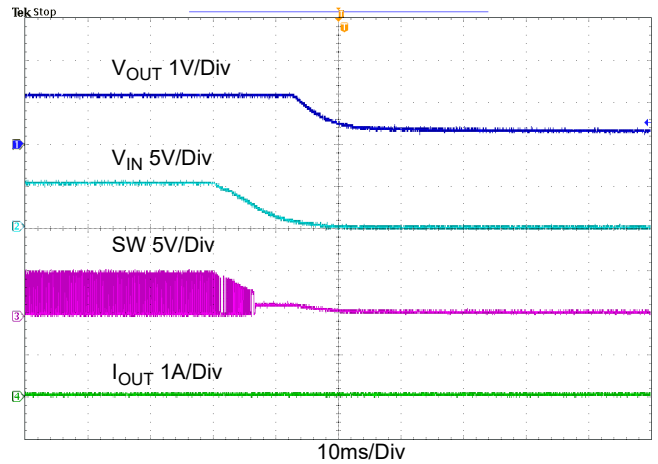

Figure 19. Shutdown at 0A

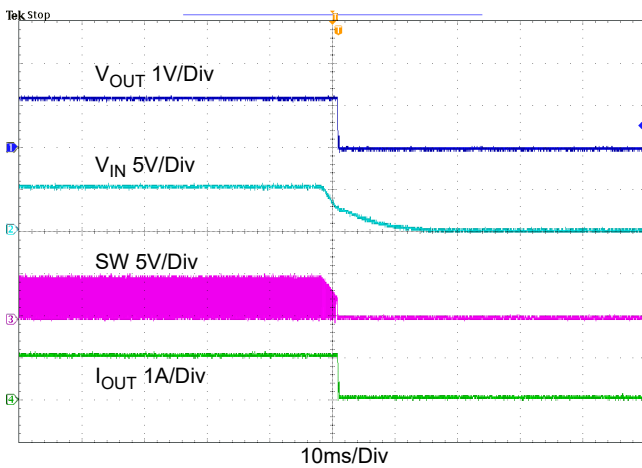

Figure 20. Shutdown at 5A

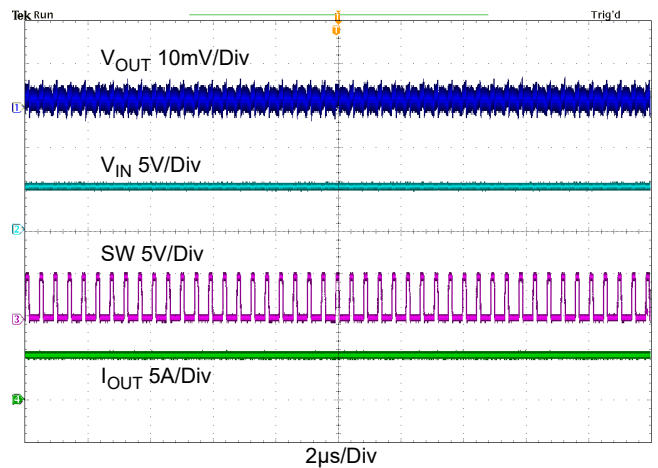

Figure 21. Output Ripple at 5A

$V_{IN} = 5V$, $V_{OUT} = 3.3V$, $T_A = +25^{\circ}C$. (Cont.)

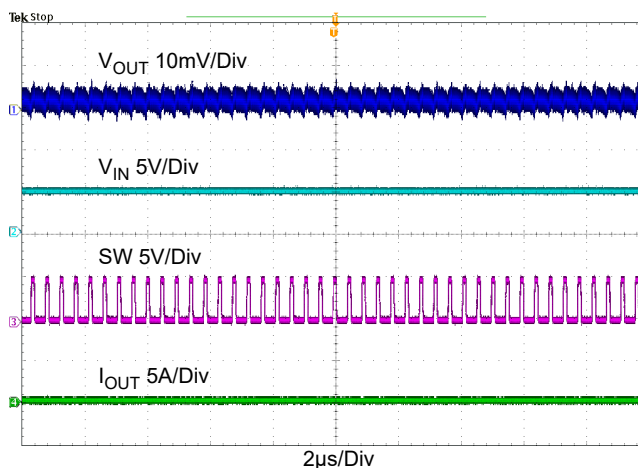

Figure 22. Output Ripple at 0A

4. Ordering Information

Part Number	Description
RTKA808015DE0020BU	2.7V~5.5V synchronous buck converter evaluation board

5. Revision History

Revision	Date	Description
1.00	Feb 21, 2023	Initial release

IMPORTANT NOTICE AND DISCLAIMER

RENESAS ELECTRONICS CORPORATION AND ITS SUBSIDIARIES (“RENESAS”) PROVIDES TECHNICAL SPECIFICATIONS AND RELIABILITY DATA (INCLUDING DATASHEETS), DESIGN RESOURCES (INCLUDING REFERENCE DESIGNS), APPLICATION OR OTHER DESIGN ADVICE, WEB TOOLS, SAFETY INFORMATION, AND OTHER RESOURCES “AS IS” AND WITH ALL FAULTS, AND DISCLAIMS ALL WARRANTIES, EXPRESS OR IMPLIED, INCLUDING, WITHOUT LIMITATION, ANY IMPLIED WARRANTIES OF MERCHANTABILITY, FITNESS FOR A PARTICULAR PURPOSE, OR NON-INFRINGEMENT OF THIRD PARTY INTELLECTUAL PROPERTY RIGHTS.

These resources are intended for developers skilled in the art designing with Renesas products. You are solely responsible for (1) selecting the appropriate products for your application, (2) designing, validating, and testing your application, and (3) ensuring your application meets applicable standards, and any other safety, security, or other requirements. These resources are subject to change without notice. Renesas grants you permission to use these resources only for development of an application that uses Renesas products. Other reproduction or use of these resources is strictly prohibited. No license is granted to any other Renesas intellectual property or to any third party intellectual property. Renesas disclaims responsibility for, and you will fully indemnify Renesas and its representatives against, any claims, damages, costs, losses, or liabilities arising out of your use of these resources. Renesas' products are provided only subject to Renesas' Terms and Conditions of Sale or other applicable terms agreed to in writing. No use of any Renesas resources expands or otherwise alters any applicable warranties or warranty disclaimers for these products.

(Disclaimer Rev.1.0 Mar 2020)

Corporate Headquarters

TOYOSU FORESIA, 3-2-24 Toyosu,
Koto-ku, Tokyo 135-0061, Japan
www.renesas.com

Contact Information

For further information on a product, technology, the most up-to-date version of a document, or your nearest sales office, please visit:
www.renesas.com/contact/

Trademarks

Renesas and the Renesas logo are trademarks of Renesas Electronics Corporation. All trademarks and registered trademarks are the property of their respective owners.