

# RZ/G3S SMARC Module Board

User's Manual: Hardware

Renesas Microprocessor  
RZ Family / RZ/G Series

All information contained in these materials, including products and product specifications, represents information on the product at the time of publication and is subject to change by Renesas Electronics Corp. without notice. Please review the latest information published by Renesas Electronics Corp. through various means, including the Renesas Electronics Corp. website (<http://www.renesas.com>).

## Notice

1. Descriptions of circuits, software and other related information in this document are provided only to illustrate the operation of semiconductor products and application examples. You are fully responsible for the incorporation or any other use of the circuits, software, and information in the design of your product or system. Renesas Electronics disclaims any and all liability for any losses and damages incurred by you or third parties arising from the use of these circuits, software, or information.
2. Renesas Electronics hereby expressly disclaims any warranties against and liability for infringement or any other claims involving patents, copyrights, or other intellectual property rights of third parties, by or arising from the use of Renesas Electronics products or technical information described in this document, including but not limited to, the product data, drawings, charts, programs, algorithms, and application examples.
3. No license, express, implied or otherwise, is granted hereby under any patents, copyrights or other intellectual property rights of Renesas Electronics or others.
4. You shall be responsible for determining what licenses are required from any third parties, and obtaining such licenses for the lawful import, export, manufacture, sales, utilization, distribution or other disposal of any products incorporating Renesas Electronics products, if required.
5. You shall not alter, modify, copy, or reverse engineer any Renesas Electronics product, whether in whole or in part. Renesas Electronics disclaims any and all liability for any losses or damages incurred by you or third parties arising from such alteration, modification, copying or reverse engineering.
6. Renesas Electronics products are classified according to the following two quality grades: "Standard" and "High Quality". The intended applications for each Renesas Electronics product depends on the product's quality grade, as indicated below.

"Standard": Computers; office equipment; communications equipment; test and measurement equipment; audio and visual equipment; home electronic appliances; machine tools; personal electronic equipment; industrial robots; etc.

"High Quality": Transportation equipment (automobiles, trains, ships, etc.); traffic control (traffic lights); large-scale communication equipment; key financial terminal systems; safety control equipment; etc.

Unless expressly designated as a high reliability product or a product for harsh environments in a Renesas Electronics data sheet or other Renesas Electronics document, Renesas Electronics products are not intended or authorized for use in products or systems that may pose a direct threat to human life or bodily injury (artificial life support devices or systems; surgical implantations; etc.), or may cause serious property damage (space system; undersea repeaters; nuclear power control systems; aircraft control systems; key plant systems; military equipment; etc.). Renesas Electronics disclaims any and all liability for any damages or losses incurred by you or any third parties arising from the use of any Renesas Electronics product that is inconsistent with any Renesas Electronics data sheet, user's manual or other Renesas Electronics document.
7. No semiconductor product is absolutely secure. Notwithstanding any security measures or features that may be implemented in Renesas Electronics hardware or software products, Renesas Electronics shall have absolutely no liability arising out of any vulnerability or security breach, including but not limited to any unauthorized access to or use of a Renesas Electronics product or a system that uses a Renesas Electronics product. RENESAS ELECTRONICS DOES NOT WARRANT OR GUARANTEE THAT RENESAS ELECTRONICS PRODUCTS, OR ANY SYSTEMS CREATED USING RENESAS ELECTRONICS PRODUCTS WILL BE INVULNERABLE OR FREE FROM CORRUPTION, ATTACK, VIRUSES, INTERFERENCE, HACKING, DATA LOSS OR THEFT, OR OTHER SECURITY INTRUSION ("Vulnerability Issues"). RENESAS ELECTRONICS DISCLAIMS ANY AND ALL RESPONSIBILITY OR LIABILITY ARISING FROM OR RELATED TO ANY VULNERABILITY ISSUES. FURTHERMORE, TO THE EXTENT PERMITTED BY APPLICABLE LAW, RENESAS ELECTRONICS DISCLAIMS ANY AND ALL WARRANTIES, EXPRESS OR IMPLIED, WITH RESPECT TO THIS DOCUMENT AND ANY RELATED OR ACCOMPANYING SOFTWARE OR HARDWARE, INCLUDING BUT NOT LIMITED TO THE IMPLIED WARRANTIES OF MERCHANTABILITY, OR FITNESS FOR A PARTICULAR PURPOSE.
8. When using Renesas Electronics products, refer to the latest product information (data sheets, user's manuals, application notes, "General Notes for Handling and Using Semiconductor Devices" in the reliability handbook, etc.), and ensure that usage conditions are within the ranges specified by Renesas Electronics with respect to maximum ratings, operating power supply voltage range, heat dissipation characteristics, installation, etc. Renesas Electronics disclaims any and all liability for any malfunctions, failure or accident arising out of the use of Renesas Electronics products outside of such specified ranges.
9. Although Renesas Electronics endeavors to improve the quality and reliability of Renesas Electronics products, semiconductor products have specific characteristics, such as the occurrence of failure at a certain rate and malfunctions under certain use conditions. Unless designated as a high reliability product or a product for harsh environments in a Renesas Electronics data sheet or other Renesas Electronics document, Renesas Electronics products are not subject to radiation resistance design. You are responsible for implementing safety measures to guard against the possibility of bodily injury, injury or damage caused by fire, and/or danger to the public in the event of a failure or malfunction of Renesas Electronics products, such as safety design for hardware and software, including but not limited to redundancy, fire control and malfunction prevention, appropriate treatment for aging degradation or any other appropriate measures. Because the evaluation of microcomputer software alone is very difficult and impractical, you are responsible for evaluating the safety of the final products or systems manufactured by you.
10. Please contact a Renesas Electronics sales office for details as to environmental matters such as the environmental compatibility of each Renesas Electronics product. You are responsible for carefully and sufficiently investigating applicable laws and regulations that regulate the inclusion or use of controlled substances, including without limitation, the EU RoHS Directive, and using Renesas Electronics products in compliance with all these applicable laws and regulations. Renesas Electronics disclaims any and all liability for damages or losses occurring as a result of your noncompliance with applicable laws and regulations.
11. Renesas Electronics products and technologies shall not be used for or incorporated into any products or systems whose manufacture, use, or sale is prohibited under any applicable domestic or foreign laws or regulations. You shall comply with any applicable export control laws and regulations promulgated and administered by the governments of any countries asserting jurisdiction over the parties or transactions.
12. It is the responsibility of the buyer or distributor of Renesas Electronics products, or any other party who distributes, disposes of, or otherwise sells or transfers the product to a third party, to notify such third party in advance of the contents and conditions set forth in this document.
13. This document shall not be reprinted, reproduced or duplicated in any form, in whole or in part, without prior written consent of Renesas Electronics.
14. Please contact a Renesas Electronics sales office if you have any questions regarding the information contained in this document or Renesas Electronics products.

(Note1) "Renesas Electronics" as used in this document means Renesas Electronics Corporation and also includes its directly or indirectly controlled subsidiaries.

(Note2) "Renesas Electronics product(s)" means any product developed or manufactured by or for Renesas Electronics.

(Rev.5.0-1 October 2020)

## Corporate Headquarters

TOYOSU FORESIA, 3-2-24 Toyosu,  
Koto-ku, Tokyo 135-0061, Japan

[www.renesas.com](http://www.renesas.com)

## Contact information

For further information on a product, technology, the most up-to-date version of a document, or your nearest sales office, please visit:

[www.renesas.com/contact/](http://www.renesas.com/contact/)

## Trademarks

Renesas and the Renesas logo are trademarks of Renesas Electronics Corporation. All trademarks and registered trademarks are the property of their respective owners.

## Renesas RZ SMARC CARRIER II Disclaimer

By using this RZ SMARC CARRIER II, the User accepts the following terms, which are in addition to, and control in the event of disagreement, with Renesas' General Terms and Conditions available at <https://www.renesas.com/en-us/legal/disclaimer.html>

The RZ SMARC CARRIER II is not guaranteed to be error free, and the entire risk as to the results and performance of the RZ SMARC CARRIER II is assumed by the User. The RZ SMARC CARRIER II is provided by Renesas on an "as is" basis without warranty of any kind whether express or implied, including but not limited to the implied warranties of good workmanship, fitness for a particular purpose, title, merchantability, and non-infringement of intellectual property rights. Renesas expressly disclaims any implied warranty.

Renesas does not consider the RZ SMARC CARRIER II to be a finished product and therefore the RZ SMARC CARRIER II may not comply with some requirements applicable to finished products, including, but not limited to recycling, restricted substances and electromagnetic compatibility regulations. Refer to Certifications section, for information about certifications and compliance information for the RZ SMARC CARRIER II. It is the kit User's responsibility to make sure the kit meets any local requirements applicable to their region.

Renesas or its affiliates shall in no event be liable for any loss of profit, loss of data, loss of contract, loss of business, damage to reputation or goodwill, any economic loss, any reprogramming or recall costs (whether the foregoing losses are direct or indirect) nor shall Renesas or its affiliates be liable for any other direct or indirect special, incidental or consequential damages arising out of or in relation to the use of this RZ SMARC CARRIER II, even if Renesas or its affiliates have been advised of the possibility of such damages.

Renesas has used reasonable care in preparing the information included in this document, but Renesas does not warrant that such information is error free nor does Renesas guarantee an exact match for every application or parameter to part numbers designated by other vendors listed herein. The information provided in this document is intended solely to enable the use of Renesas products. No express or implied license to any intellectual property right is granted by this document or in connection with the sale of Renesas products. Renesas reserves the right to make changes to specifications and product descriptions at any time without notice. Renesas assumes no liability for any damages incurred by you resulting from errors in or omissions from the information included herein. Renesas cannot verify, and assumes no liability for, the accuracy of information available on another company's website.

## Precautions

This Evaluation Kit is only intended for use in a laboratory environment under ambient temperature and humidity conditions. A safe separation distance should be used between this and any sensitive equipment. Its use outside the laboratory, classroom, study area, or similar such area invalidates conformity with the protection requirements of the Electromagnetic Compatibility Directive and could lead to prosecution.

The product generates, uses, and can radiate radio frequency energy and may cause harmful interference to radio communications. There is no guarantee that interference will not occur in a particular installation. If this equipment causes harmful interference to radio or television reception, which can be determined by turning the equipment off or on, you are encouraged to try to correct the interference by one or more of the following measures:

- Ensure attached cables do not lie across the equipment.
- Reorient the receiving antenna.
- Increase the distance between the equipment and the receiver.
- Connect the equipment into an outlet on a circuit different from that which the receiver is connected.
- Power down the equipment when not in use.
- Consult the dealer or an experienced radio/TV technician for help.

Note: It is recommended that wherever possible shielded interface cables are used.

The product is potentially susceptible to certain EMC phenomena. To mitigate against them it is recommended that the following measures be undertaken:

- The user is advised that mobile phones should not be used within 10 m of the product when in use.
- The user is advised to take ESD precautions when handling the equipment.

The Evaluation Kit does not represent an ideal reference design for an end product and does not fulfill the regulatory standards for an end product.

## General Precautions in the Handling of Microprocessing Unit and Microcontroller Unit Products

The following usage notes are applicable to all Microprocessing unit and Microcontroller unit products from Renesas. For detailed usage notes on the products covered by this document, refer to the relevant sections of the document as well as any technical updates that have been issued for the products.

### 1. Precaution against Electrostatic Discharge (ESD)

A strong electrical field, when exposed to a CMOS device, can cause destruction of the gate oxide and ultimately degrade the device operation. Steps must be taken to stop the generation of static electricity as much as possible, and quickly dissipate it when it occurs. Environmental control must be adequate. When it is dry, a humidifier should be used. This is recommended to avoid using insulators that can easily build up static electricity. Semiconductor devices must be stored and transported in an anti-static container, static shielding bag or conductive material. All test and measurement tools including work benches and floors must be grounded. The operator must also be grounded using a wrist strap. Semiconductor devices must not be touched with bare hands. Similar precautions must be taken for printed circuit boards with mounted semiconductor devices.

### 2. Processing at power-on

The state of the product is undefined at the time when power is supplied. The states of internal circuits in the LSI are indeterminate and the states of register settings and pins are undefined at the time when power is supplied. In a finished product where the reset signal is applied to the external reset pin, the states of pins are not guaranteed from the time when power is supplied until the reset process is completed. In a similar way, the states of pins in a product that is reset by an on-chip power-on reset function are not guaranteed from the time when power is supplied until the power reaches the level at which resetting is specified.

### 3. Input of signal during power-off state

Do not input signals or an I/O pull-up power supply while the device is powered off. The current injection that results from input of such a signal or I/O pull-up power supply may cause malfunction and the abnormal current that passes in the device at this time may cause degradation of internal elements. Follow the guideline for input signal during power-off state as described in your product documentation.

### 4. Handling of unused pins

Handle unused pins in accordance with the directions given under handling of unused pins in the manual. The input pins of CMOS products are generally in the high-impedance state. In operation with an unused pin in the open-circuit state, extra electromagnetic noise is induced in the vicinity of the LSI, an associated shoot-through current flows internally, and malfunctions occur due to the false recognition of the pin state as an input signal become possible.

### 5. Clock signals

After applying a reset, only release the reset line after the operating clock signal becomes stable. When switching the clock signal during program execution, wait until the target clock signal is stabilized. When the clock signal is generated with an external resonator or from an external oscillator during a reset, ensure that the reset line is only released after full stabilization of the clock signal. Additionally, when switching to a clock signal produced with an external resonator or by an external oscillator while program execution is in progress, wait until the target clock signal is stable.

### 6. Voltage application waveform at input pin

Waveform distortion due to input noise or a reflected wave may cause malfunction. If the input of the CMOS device stays in the area between  $V_{IL}$  (Max.) and  $V_{IH}$  (Min.) due to noise, for example, the device may malfunction. Take care to prevent chattering noise from entering the device when the input level is fixed, and also in the transition period when the input level passes through the area between  $V_{IL}$  (Max.) and  $V_{IH}$  (Min.).

### 7. Prohibition of access to reserved addresses

Access to reserved addresses is prohibited. The reserved addresses are provided for possible future expansion of functions. Do not access these addresses as the correct operation of the LSI is not guaranteed.

### 8. Differences between products

Before changing from one product to another, for example to a product with a different part number, confirm that the change will not lead to problems. The characteristics of a microprocessing unit or microcontroller unit products in the same group but having a different part number might differ in terms of internal memory capacity, layout pattern, and other factors, which can affect the ranges of electrical characteristics, such as characteristic values, operating margins, immunity to noise, and amount of radiated noise. When changing to a product with a different part number, implement a system-evaluation test for the given product.

# Table of Contents

1.	Introduction .....	7
1.1	Kit Contents .....	9
1.2	Module Assembly .....	10
2.	System Description .....	11
2.1	G3S SMARC EVK Functional Block.....	13
2.2	G3S SMARC EVK Interface Mapping .....	14
2.3	Board Configuration and Status .....	16
2.3.1	SW_CONFIG .....	16
2.3.2	GPIO4_SEL .....	17
2.4	List of Pin Functions .....	18
2.4.1	LED Indicators .....	18
2.5	Recommended Operating Condition .....	18
3.	Functional Specifications .....	19
3.1	Processor.....	19
3.2	Power Supply.....	20
3.3	Clock.....	23
3.4	Reset.....	24
3.5	LPDDR4 SDRAM.....	25
3.6	xSPI Interface .....	25
3.7	eMMC Memory .....	25
3.8	uSD0 Card Interface .....	25
3.9	uSD2 Card Interface .....	26
3.10	ADC .....	26
3.11	I3C .....	27
3.12	I2C .....	27
3.13	JTAG.....	28
3.13.1	JTAG Adaptor .....	29
3.14	Gigabit Ethernet Interface.....	30
3.15	Current Monitor.....	30
3.16	SMARC Edge Connector.....	31
3.16.1	Display Interfaces .....	31
3.16.2	Camera Interfaces .....	31
3.16.3	SDIO Card (4 bit) Interface .....	31
3.16.4	SPI Interfaces .....	32
3.16.5	Audio.....	32
3.16.6	I2C Interfaces.....	33

3.16.7	Asynchronous Serial Ports.....	33
3.16.8	CAN Bus .....	34
3.16.9	USB Interfaces.....	34
3.16.10	PCI Express .....	35
3.16.11	SATA.....	35
3.16.12	Ethernet.....	36
3.16.13	GPIO .....	37
REVISION HISTORY .....		38

## 1. Introduction

The RZ/G3S SMARC Module board (hereinafter referred to as “G3S SMARC Module”) is a platform designed according to the SMARC 2.1.1 Specification to evaluate the Renesas RZ/G3S microprocessor.

Basically, the G3S SMARC Module is connected to the Renesas RZ SMARC Series Carrier Board II (hereinafter referred to as “RZ SMARC Carrier II”) and used as the RZ/G3S SMARC Evaluation Board (hereinafter referred to as “G3S SMARC EVK”).

There are two types of RZ/G3S SMARC EVK, RTK9845S33S01000BE and RTK9845S37S01000BE. RTK9845S33S01000BE is equipped with R9A08G045S33GBG (for which the security is not supported) as the microprocessor, and RTK9845S37S01000BE is equipped with R9A08G045S37GBG (for which the security is supported). RTK9845S37S01000BE corresponds to the security type.

This guide includes system setup and configuration. This guide also provides detailed information on the overall design and use of the G3S SMARC Module from a hardware system perspective.

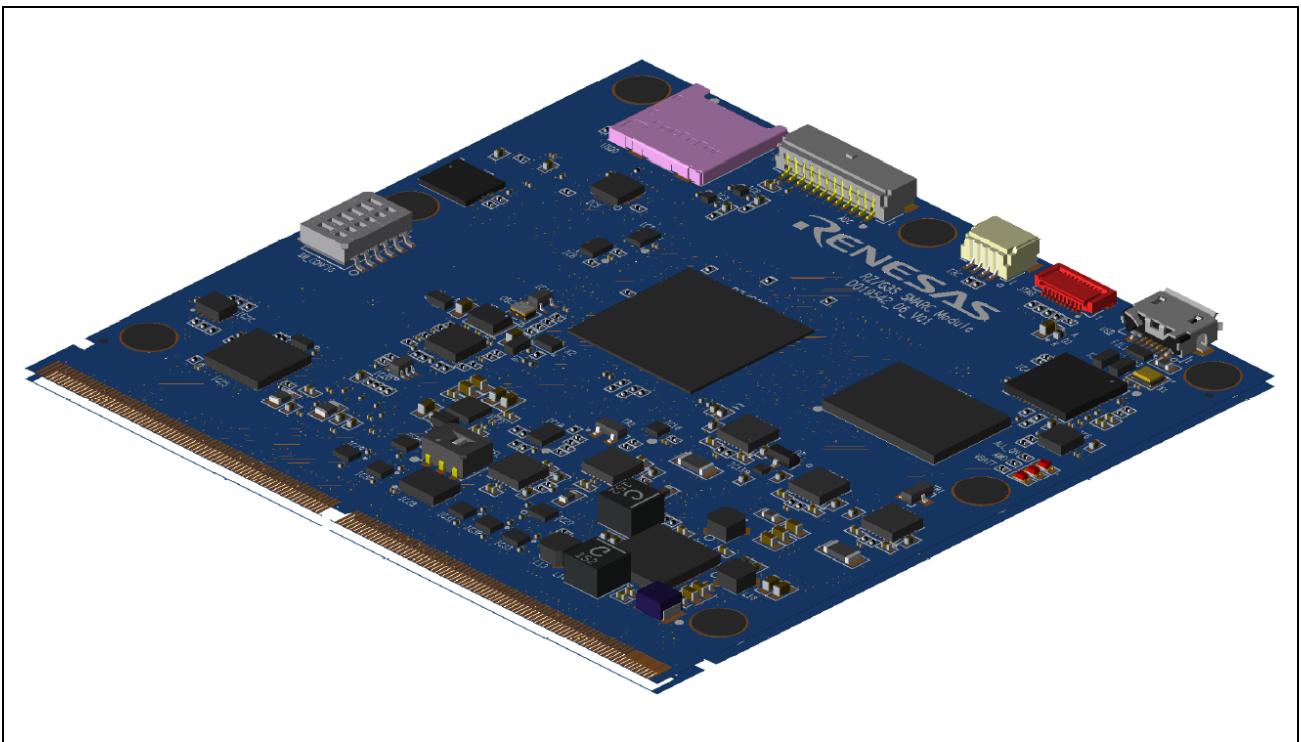

Figure 1.1 RZ/G3S SMARC Module Board

The key features of the G3S SMARC Module are as follows.

Board Features	Details
Processor	RTK9845S33S01000BE: RZ/G3S (P/N: R9A08G045S33GBG), 14 mm x 14 mm, 0.5-mm pitch, 359-pin PBGA RTK9845S37S01000BE: RZ/G3S (P/N: R9A08G045S37GBG), 14 mm x 14 mm, 0.5-mm pitch, 359-pin PBGA
Memory	1GB 512Mx16 LPDDR4 SDRAM supporting data rate up to 1600MT/s Micro SD card slot with default, high-speed, UHS-I/SDRR50, SDR104 transfer modes support 64GB eMMC flash with HS200 transfer mode support Micro SD card slot with default, high-speed transfer modes support 128Mbit Quad SPI flash memory
Supported interface and peripherals	Supports 10-pin JTAG connection from a debugger Supports ADC connection for 8 channels I3C interface 5x ISL28025FRZ for current monitoring 2x Gigabit Ethernet Transceiver 9-channel PMIC (P/N: RAA215300A2GNP#HA3) 6-channel clock generator (P/N: 5L35023B-615NLGI)
Board dimensions	82mm(W) * 80mm(L), 6-layer

The G3S SMARC Module may be used in any carrier board which follows the SMARC 2.1.1 Specification, however, Renesas recommends using the Renesas RZ SMARC Carrier II board.

The details of the RZ SMARC Carrier II board are to be found in the **RZ SMARC Carrier II User Manual**.



## 1.1 Kit Contents

The following components are included in the RZ/G3S SMARC Module Board Kit (P/N: RTK9843S33C01000BE or RTK9843S37C01000BE).

- RZ/G3S SMARC Module Board
- RZ SMARC Series JTAG Adaptor Cable  
(hereinafter referred to as “SMARC JTAG Adaptor”)

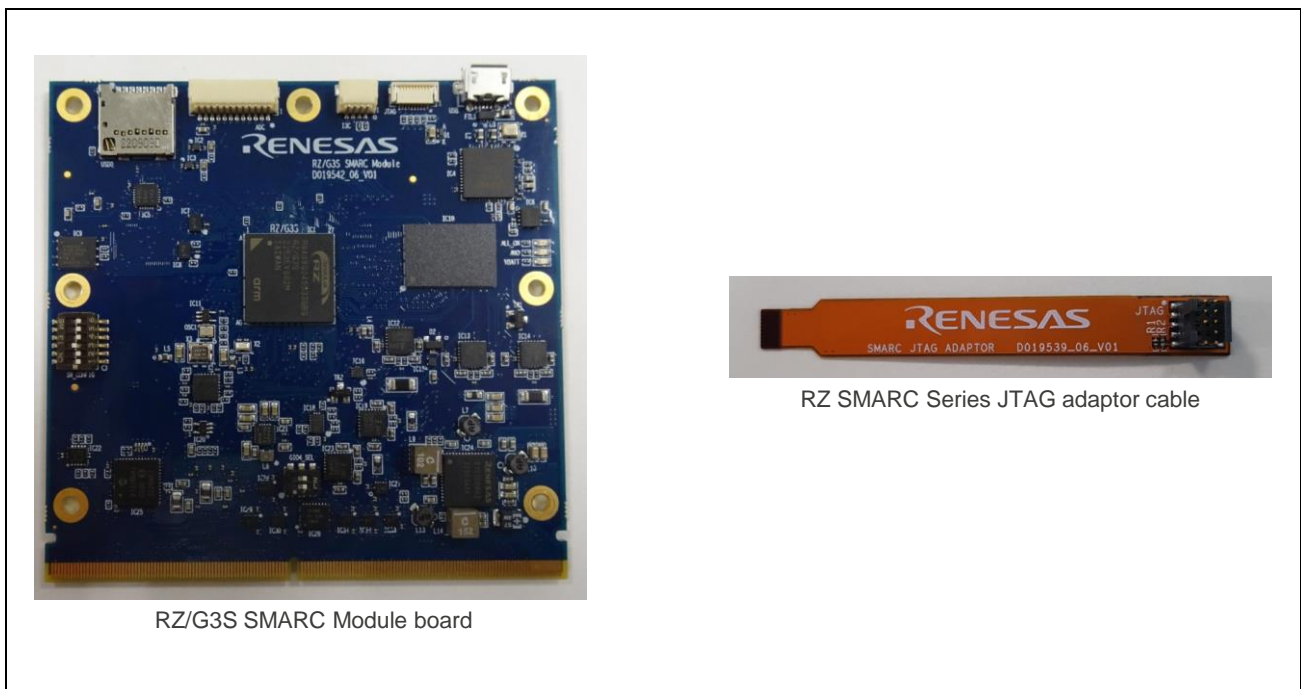

Figure 1.2 RZ/G3S SMARC Module Board Kit Contents

If you have purchased the RZ/G3S SMARC Evaluation Board Kit, your contents will include:

- RZ/G3S SMARC Module Board Kit (P/N: RTK9843S33C01000BE or RTK9843S37C01000BE)
  - RZ/G3S SMARC Module Board
  - RZ SMARC Series JTAG Adaptor Cable
- RZ/G3S SMARC Carrier Board II Kit (P/N: RTK9SMCB02000BE)
  - RZ SMARC Series Carrier Board II
  - USB Type-A to USB Micro B cable for serial debugging
  - Accessories bag:
    - 2off M2.5 x6mm pan-head machine screws (for securing M.2 cards)
    - 1off 2.5mm spacer (for securing M.2 key B cards)

### NOTE

The Module will have been fitted to the Carrier using 7off M2.5 x4mm pan-head machine screws.

## 1.2 Module Assembly

The G3S SMARC Module can only be used when fitted to a SMARC compliant Carrier board.

Secure the Module using 7 off M2.5 x4mm pan-head machine screws (these are provided with the RZ SMARC Carrier II).

If connection to the JTAG interface is required, it may be necessary to connect the SMARC JTAG Adaptor. Refer to the section heading **JTAG**.

## 2. System Description

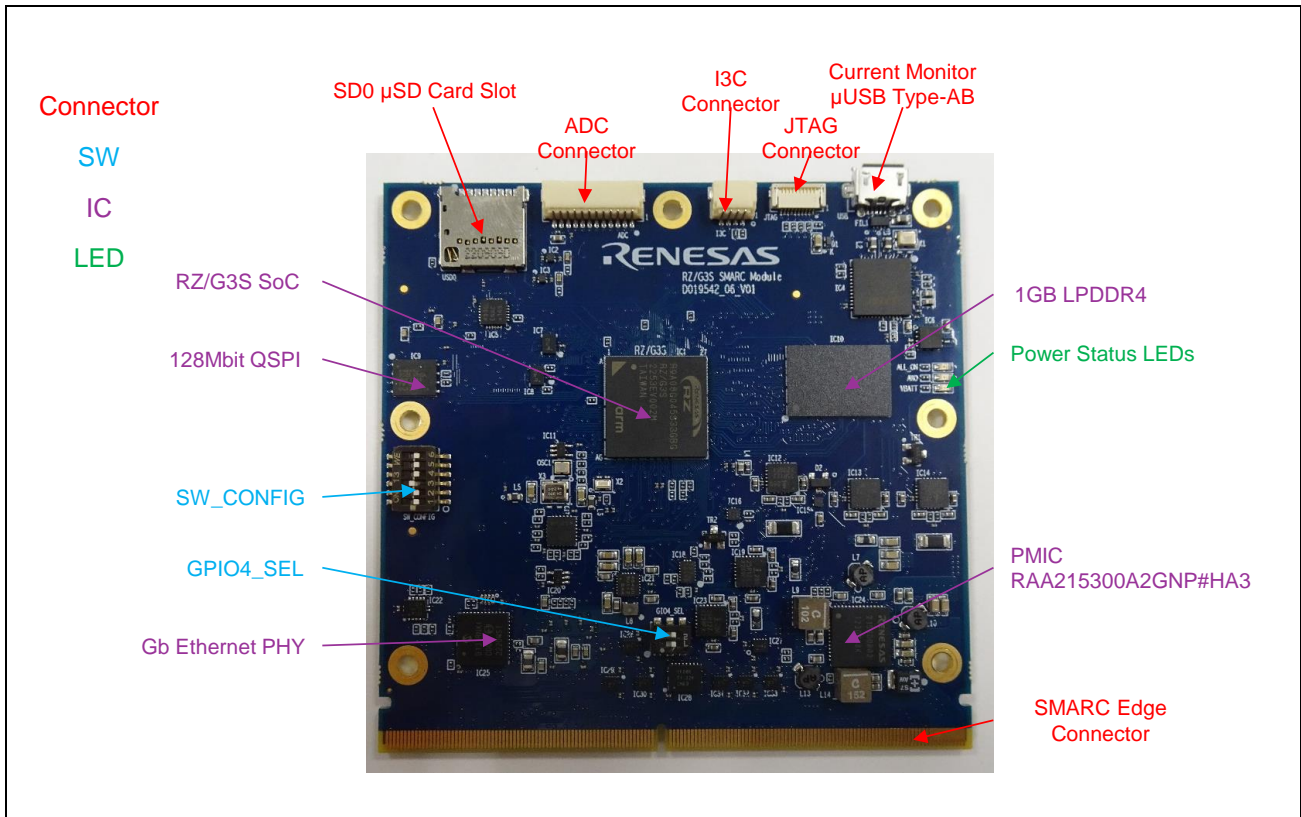

Figure 2.1 RZ/G3S SMARC Module Board Top View



Figure 2.2 RZ/G3S SMARC Module Board Bottom View

The G3S SMARC Module has several switched configuration options and on-board interfaces. These are detailed in the following sections.

The default settings are highlighted.



## 2.2 G3S SMARC EVK Interface Mapping

Renesas parts are highlighted.

Table 2.1 Interface Mapping (1/2)

SMARC Interface Name	RZ/G3S I/F	Device Part Number	Description
USB0	USB2.0 ch0	629105150921	USB Type-microAB receptacle
USB1	USB2.0 ch1	uPD720115K8-711-BAK-A	USB Hub IC
		72309-8014BLF	USB Type-A receptacle
USB2	—	692122030100	USB Type-A receptacle
USB3	—	1054500101	USB Type-C receptacle
USB4	—	72309-8014BLF	USB Type-A receptacle
USB5	—	72309-8014BLF	USB Type-A receptacle
CAN0	CAN ch0	TCAN1046VDMTRQ1	CAN transceiver
		SM03B-SRSS-TB(LF)(SN)	3-pin connector
CAN1	CAN ch1	TCAN1046VDMTRQ1	CAN transceiver
		SM03B-SRSS-TB(LF)(SN)	3-pin connector
I2S0	SSI ch3	DA7212-01UM	Audio Codec
		STX-4335-5BGP-S1	Connector for Stereo Headphone, Stereo Mic, Aux
		M20-9990246	Pin header for speaker
I2S2	SSI ch0	MDT420E01001	M.2 Key E for I2S interface
SPI0	—	GRPB122VWQS-RC	24-pin header
SPI1	RSPI ch0	SSW-106-02-T-D-RA	PMOD Type-2A connector
SER0	SCIF ch1	SSW-106-02-T-D-RA	PMOD Type-3A connector (*1)
		MDT420E01001	M.2 Key E (*1)
SER1	SCIF ch3	110990037	Grove connector
SER2	—	MDT420E01001	M.2 Key E (*1)
SER3	SCIF ch0	FT234XD-T	USB to UART conversion IC
		629105150921	USB Type-microB receptacle for UART Debug
PCIE_A	PCIe Gen2	10061913-111PLF	PCIe 4x Slot
		MDT420B01001	M. 2 Key B
		MDT420E01001	M. 2 Key E
		78646-3001	SIM card for M. 2 Key B
SATA	—	GRPB122VWQS-RC	GPIO pin header
HDMI	—	46765-1301	Micro HDMI connector
LVDS0	—	2041262-1	Mini PCI Express & mSATA connector
		ADV7535BCBZ-RL	MIPI DSI to HDMI conversion IC (*2)
LVDS1	—	46765-1301	Micro HDMI connector (*2)
		2041262-1	Mini PCI Express & mSATA connector
CSI0	—	2-1734592-2	22-pin FPC connector
CSI1	—	2-1734592-2	22-pin FPC connector
GBE0	Ether ch0	KSZ9131RNXC	Ethernet PHY
		2301997-7	Stacked RJ45 connector
GBE1	Ether ch1	KSZ9131RNXC	Ethernet PHY
		2301997-7	Stacked RJ45 connector

Table 2.1 Interface Mapping (2/2)

SMARC Interface Name	RZ/G3S I/F	Device Part Number	Description
I2C_GP	RIIC ch0	GRPB122VWQS-RC	GPIO pin header
		MDT420B01001	M. 2 Key E for I2C interface
		DA7212-01UM	Audio Codec for I2C interface
		SSW-106-02-T-D-RA	PMOD Type-6A connector
I2C_PM	RIIC ch1	ISL28022FRZ	Current monitor for measuring SMARC module
		SLG4L45949	GreenPAK (PCIe Data Multiplexing Control, PCIe Slot Enable, M.2 Key E Enable, M.2 Key B Enable)
		SLG4R45950	GreenPAK (PCIe Slot Reset, M.2 Key E Reset, M.2 Key B Reset)
		SLG4AR45947	GreenPAK (GPIO and SER0 Multiplexing Control, M.2 Key B Reset/Power off, M.2 Key E Disable)
		SLG4AE45948	GreenPAK (M.2 Key B Configuration Decoding, USB2, I2S2 and SDIO Multiplexing Control, USB1 Hub Enable)
		RAA215300A2GNP#HA3	PMIC
		SLG7RN46420	GreenPAK (Power Regulator)
		SLG7RN46131	GreenPAK (Power/Reset control)
		ISL28025FRZ	Clock generator
I2C_LCD	—	2041262-1	Mini PCI Express & mSATA connector
I2C_CAM0	—	2-1734592-2	22-pin FPC connector
I2C_CAM1	—	2-1734592-2	22-pin FPC connector
—	SD/MMC ch0	1040310811	microSD card connector
		MTFC64GASAQHD-IT	64GB eMMC memory
SDIO	SD ch1	1040310811	microSD card connector
—	SD ch2	1040310811	microSD card connector
—	DDR	MT53E512M16D1FW-046WT	1GB LPDDR4 SDRAM
—	xSPI	AT25QL128A_MHE	128Mbit Quad SPI Flash memory
—	ADC	SM12B-SRSS-TB(LF)(SN)	12-pin connector
—	I3C	SM04B-SRSS-TB(LF)(SN)	4-pin connector
—	JTAG	10051922-1010EHLF	10-pin connector
—	CPG	5L35023B-615NLGI	Clock Generator
		830208214909	Oscillator for AUDIO_CLK2
—	Power	ISL28025FR12Z	Current monitor for measuring five power rails on SMARC module
		FT232HQ	USB to I2C conversion IC
		629105150921	USB Type-microB receptacle

Note 1. Select whether to assign PMOD1 to SER0 or M.2 Key E to SER0. M.2 Key cannot be assigned to SER2 since SER2 is not connected to the G3S SMARC module.

Note 2. The SMARC MIPI DSI to HDMI Adaptor is required. It is bundled with the G3S SMARC EVK.

## 2.3 Board Configuration and Status

This section provides details of the G3S SMARC Module switch settings.

### 2.3.1 SW\_CONFIG

A bank of 6-switches is used to configure operating modes of the Module. The default settings are **highlighted**.

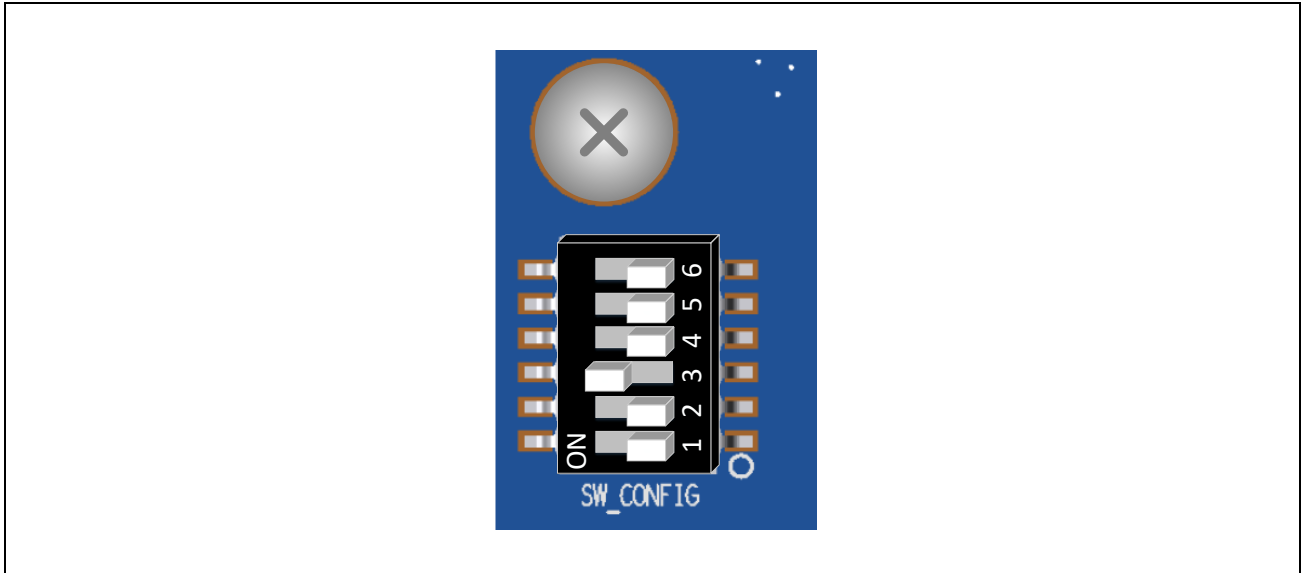

Figure 2.4 The Location and the Default Setting of the SW\_CONFIG

Table 2.2 DIP Switch “SW\_CONFIG” Settings

SW_CONFIG[x]	Signal	ON	OFF
6	RZ_BOOTCPUSEL	Cold boot from Cortex-M33(w/o FPU)	Cold boot from Cortex-A55
5	RZ_MD_CLKS	SSCG is disabled	SSCG is enabled
4	SW_I3C_VIO_SEL	I3C voltage is 1.2 V	I3C voltage is 1.8 V
3	SW_SD2_EN	SD2 is disabled.	SD2 is enabled
2	SW_SD0_DEV_SEL	SD0 connected to uSD0 card	SD0 connected to eMMC
1	RZ_DEBUGEN	JTAG Debug is disabled	JTAG Debug is enabled



### 2.3.2 GPIO4\_SEL

The SMARC GPIO4 signal from/to the Carrier II may be used for RZ\_TAMPIN as an alternative to the default port pin. The default settings are highlighted.

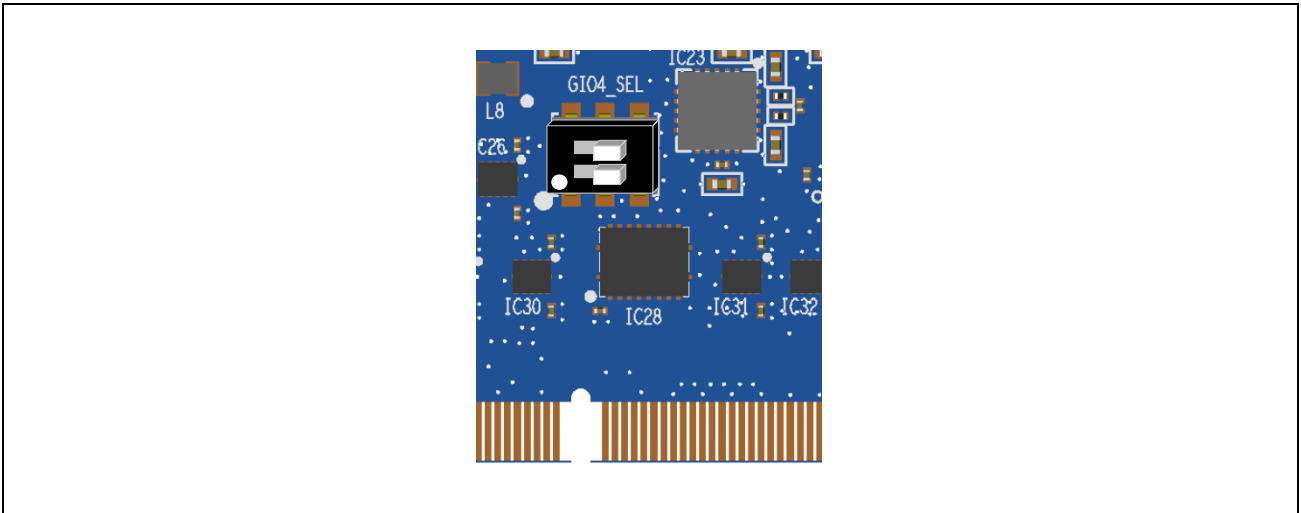

Figure 2.5 The Location and the Default Setting of the GPIO4\_SEL

Table 2.3 DIP Switch “GPIO4\_SEL” Settings (1/2)

GPIO4_SEL	GPIO4 Function
1 – 2	SMARC GPIO4 pin is connected to RZ_TAMPIN
2 – 3	SMARC GPIO4 pin is connected to RZ/G3S P18_0
<i>Note:</i> RZ_TAMPIN is pulled up to VBATT_VDD	

Table 2.3 DIP Switch “GPIO4\_SEL” Settings (2/2)





GPIO4_SEL	Function
4 – 5	Spare – unused
5 – 6	Spare – unused

## 2.4 List of Pin Functions

### 2.4.1 LED Indicators

The RZ/G3S has the following four power modes depending on the power on/off combination of the power domain. There are three Red LEDs on the G3S SMARC Module to provide indication of the RZ/G3S power modes.

Table 2.4 Indicator LEDs – Power Status

ALL_ON	Power Mode
	<b>ALL_ON</b> All CPUs and peripheral modules are active
	<b>AWO</b> Cortex-M33 and peripheral modules in PD_VCC and PD_VBATT domain are active
	<b>VBATT</b> Only RTC, tamper detection and backup registers are active
	<b>ALL_OFF</b> All CPUs and peripheral modules are disabled

## 2.5 Recommended Operating Condition

**Table 2.5** lists operating conditions of the G3S SMARC Module.

Table 2.5 Operating Conditions of G3S SMARC Module

Symbol	Item	Rated Value	Note
VDD_IN	Power voltage *1	3.0 V to 5.25 V	Reference: SMARC 2.1.1 Specification
—	Maximum power consumption	5 A	Reference: SMARC 2.1.1 Specification
T <sub>opr</sub>	Operating ambient temperature *2	0°C to 40°C	Do not expose to condensation or corrosive gases

Note 1. Supplied from the connected RZ SMARC Carrier II.

Note 2. The ambient temperature is the air temperature at a point as close to the board as possible.

## 3. Functional Specifications

### 3.1 Processor

The RZ/G3S (P/N: R9A08G045S33GBG or R9A08G045S37GBG, 14 mm × 14 mm, 0.5-mm pitch, 359-pin) includes a single ARM Cortex-A55 core with speeds up to 1.2 GHz. Dual Arm Cortex-M33 cores with speeds up to 250 MHz is for real-time and low-power processing. One Arm Cortex-M33 has FPU function. Low power mode is supported and realized low power consumption of micro ampere class. Also, dual 1Gbit/s Ethernet controllers and PCI Express Gen2 drive gateway applications with low latency.

The RZ/G3S is useful for application such as:

- IoT gateway

For details on the processor, see the **RZ SMARC Series Carrier Board II User's Manual: Hardware**.

### 3.2 Power Supply

Figure 3.1 shows a block diagram of power system of the G3S SMARC EVK.

This board has one USB Type-C receptacle for power input with USB Power Delivery. The input voltage of VBUS can be selected among 5 V, 9 V, 15 V, and 20 V.

The 5 V power supply is supplied to the PMIC (RAA215300A2GNP#HA3) installed in the G3S SMARC Module, and the PMIC generates the power supply voltage for each interface.

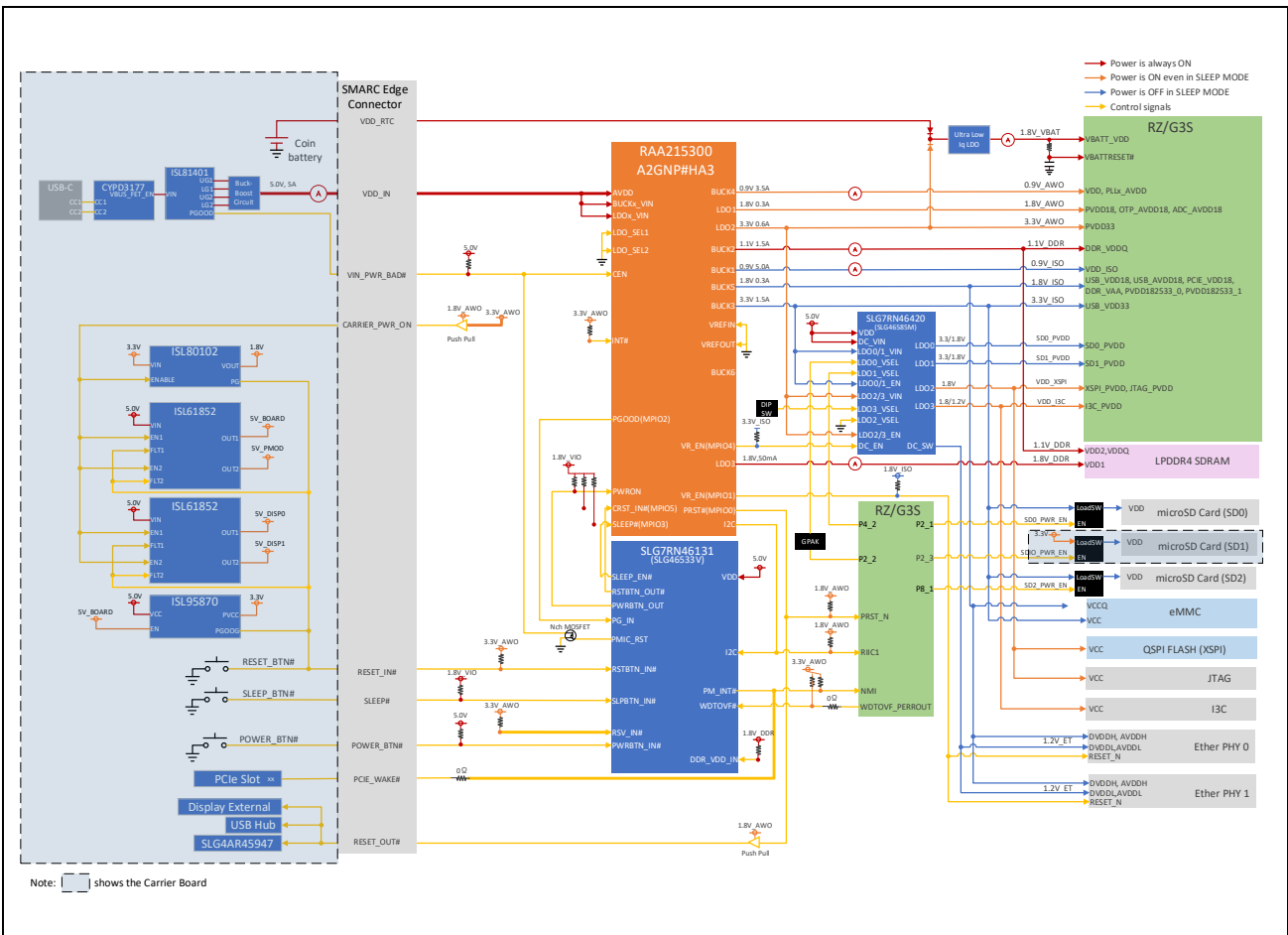

Figure 3.1 Power System Circuitry of G3S SMARC EVK

The RZ/G3S SMARC EVK supports two low-power modes: VBATT Retention mode and AWO + DDR Retention mode. **Figure 3.2** and **Figure 3.3** show the power sequence of the transition/return between ALL\_ON mode and AWO + DDR Retention mode, and the transition/return between ALL\_ON mode and VBATT Retention mode, respectively. The G3S SoC power rails are shown in red text. The control signals for PMIC or GreenPAKs are shown in blue. The control signals for the G3S SoC, JTAG, and Ethernet are shown in light green.

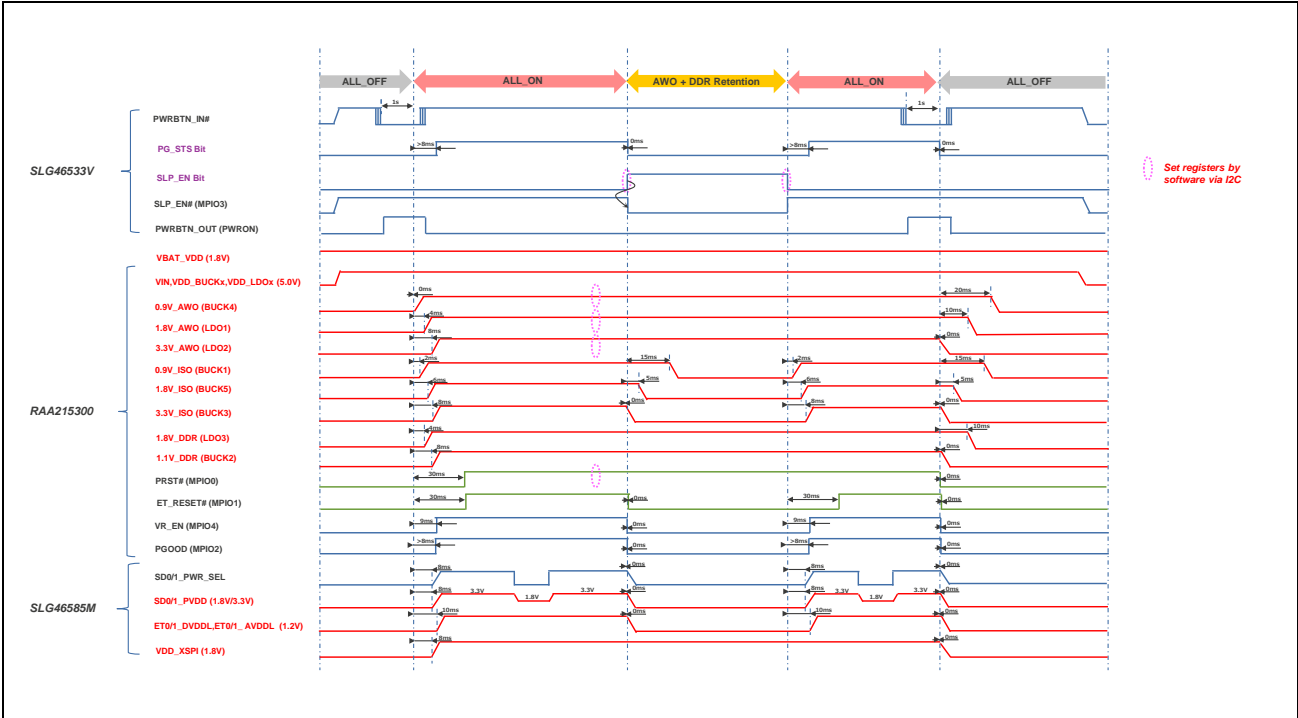

Figure 3.2 Power Sequence of G3S SMARC EVK when the Power Mode Changes from ALL\_OFF to ALL\_ON, ALL\_ON to AWO + DDR Retention, AWO + DDR Retention to ALL\_ON, and ALL\_ON to ALL\_OFF

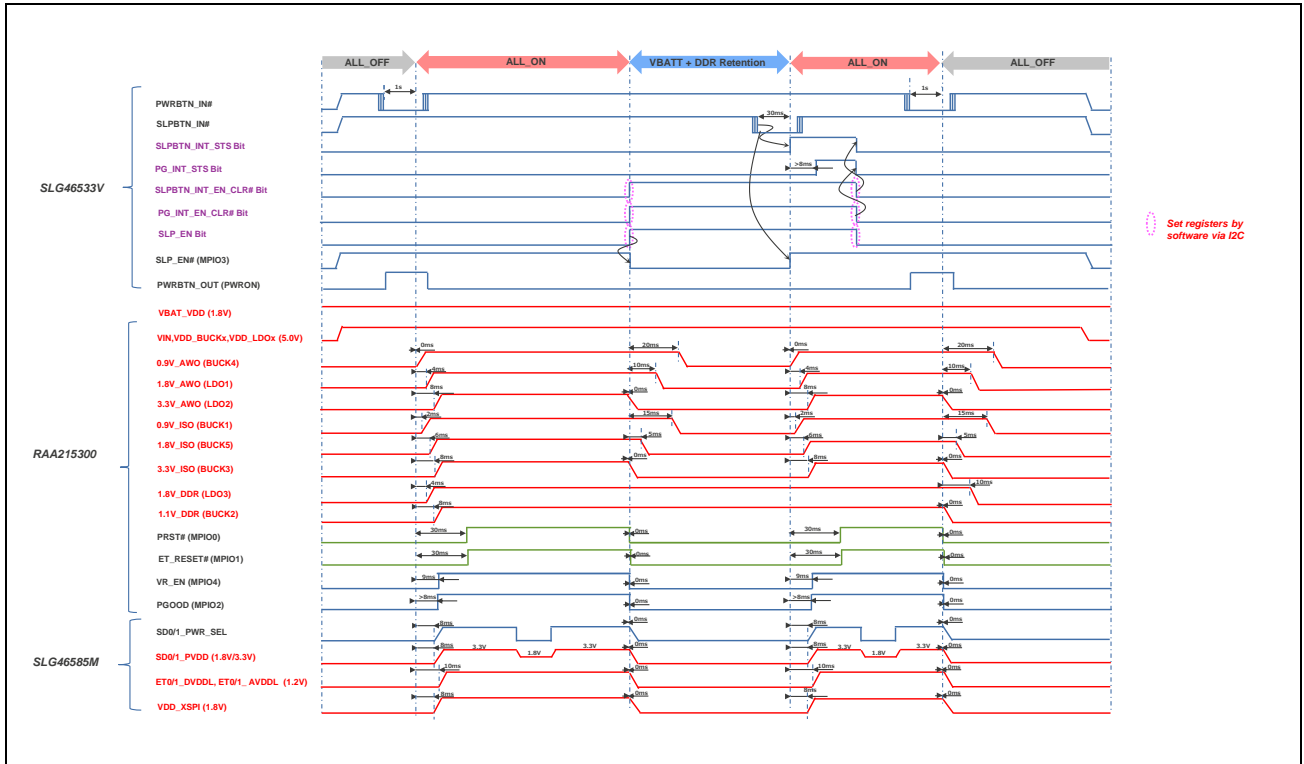

Figure 3.3 Power Sequence of G3S SMARC EVK when the Power Mode Changes from ALL\_OFF to ALL\_ON, ALL\_ON to VBATT + DDR Retention, VBATT + DDR Retention to ALL\_ON, and ALL\_ON to ALL\_OFF

### 3.3 Clock

The clock generator (part number 5L35023B-615NLGI) provides the clock required for the G3S SoC and peripheral interfaces.

The 5L35023B is Renesas VersaClock@ 3S programmable clock generator and supports 6 unique frequency outputs.

The 5L35023B-615NLGI takes the 24 MHz crystal as a reference input and provides a 24 MHz reference clock output for the G3S SoC, two 11.2896 MHz LVCMOS clock outputs for the G3S SoC and Audio Codec, one 125 MHz LVCMOS clock output for two Ethernet PHYs, and two 100 MHz LPHSCL clock outputs for the G3S SoC and a PCI Express Card Module. One oscillator provides 12.2880 MHz clock output for the G3S SoC.

An external crystal is attached to the G3S SoC to provide clock to the RTC domain of the SoC (32.768 kHz).

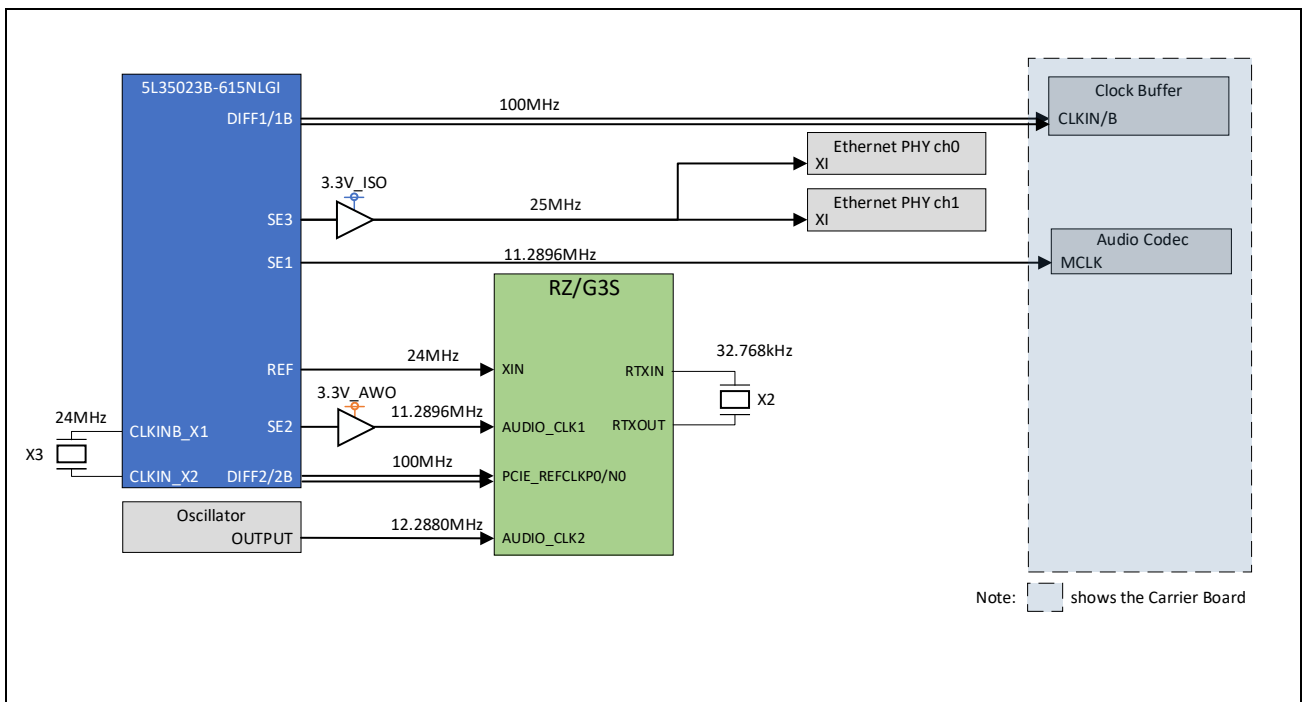

Figure 3.4 Clock Architecture of G3S SMARC EVK

Clock inputs required for peripherals such as FT232HQ, USB Hub, M.2 Key E Card Module, HDMI Transmitter are generated locally using separate crystals or oscillators. The crystals or oscillators used to provide the reference clocks for the G3S SMARC EVK peripherals are shown in the table below.

Table 3.1 Clock Table

Peripheral	Device Part Number	Frequency
FT232HQ Bridge	FL2400022	24.000 MHz
USB Hub*1	FL2400022	24.000 MHz
M.2 Key E*1	7XZ-32.768KBE	32.768 kHz
HDMI Transmitter*2	SIT1602AI-23-18E-12.000000D	12.000 MHz

Note 1. RZ SMARC Carrier II

Note 2. SMARC MIPI-DSI to HDMI Adaptor. However, the SMARC MIPI-DSI to HDMI adaptor is not bundled with the RZ/G3S SMARC EVK.

### 3.4 Reset

Figure 3.5 shows block diagrams of a reset control for the G3S SMARC EVK.

For the G3S SMARC EVK, the G3S SoC and Ethernet PHY on the G3S SMARC Module and some modules on the RZ SMARC Carrier II are controlled by the reset signal from the RAA215300.

There are two types of system resets.

- Cold reset by power-on reset
- Warm reset by the reset button switch

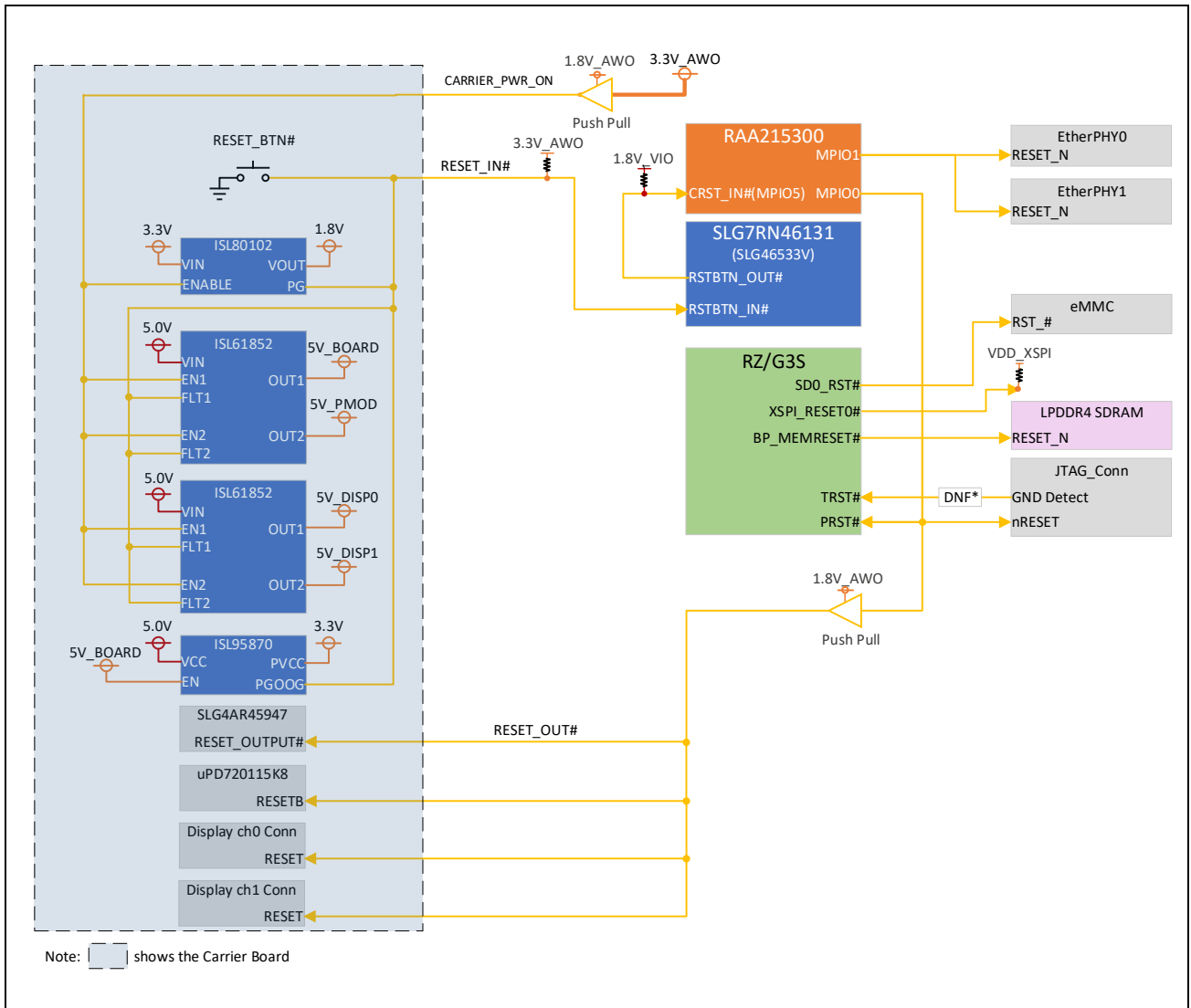

Figure 3.5 Reset Architecture of G3S SMARC EVK



### 3.5 LPDDR4 SDRAM

The G3S SMARC Module supports LPDDR4 SDRAM. A LPDDR4 SDRAM from Micron Technology (part number MT53E512M16D1FW-046WT) is provided for connection to the RZ/G3S DDR IO.

### 3.6 xSPI Interface

The G3S SMARC Module supports QSPI flash memory for xSPI interfaces. A QSPI flash memory from Renesas (part number AT25QL128A-MHE) is provided for connection to the RZ/G3S xSPI IO.

### 3.7 eMMC Memory

This eMMC is on the bottom side of the G3S SMARC Module. An eMMC from Micron Technology (part number MTFC64GASAQHD-IT) is provided for connection to the RZ/G3S MMC IO.

The RZ/G3S MMC IO may be used either for eMMC (`SW_CONFIG[2] = OFF`) or for the uSD0 Card interface (`SW_CONFIG[2] = ON`).

### 3.8 uSD0 Card Interface

This uSD card interface is on the top side of the G3S SMARC Module. Cards must be inserted with the contacts facing down.

The connector is a push-pull type.

The RZ/G3S SD0 IO may be used either for eMMC (`SW_CONFIG[2] = OFF`) or for the uSD0 Card interface (`SW_CONFIG[2] = ON`).

Additional control of the uSD0 card using the RZG3S port pins is shown below.

Table 3.2 uSD0 Signals

uSD Card Signals	RZ Port Pin	Direction	Function
uSD0 Card Detect	P0_0	Input	0: Card present 1: No card present
uSD0 Card Power Enable	P2_1	Output	0: Power disabled 1: Power enabled
uSD0 Card IO Power Select	P2_2	Output	0: 1.8 V 1: 3.3 V

### 3.9 uSD2 Card Interface

This uSD card interface is on the bottom side of the G3S SMARC Module. Cards must be inserted with the contacts facing up.

The connector is a push-pull type.

The RZ/G3S SD2 IO may be used either for SCIF1, SSI3, IRQ0, IRQ1 (SW\_CONFIG[3] = ON) or for the uSD2 Card interface (SW\_CONFIG[3] = OFF).

The uSD2 card signals, using the RZG3S port pins, are shown below.

Table 3.3 uSD2 card Signals

uSD Card Signals	RZ Port Pin	Direction	Function
uSD2 Data0	P11_2	In/Out	uSD2 data
uSD2 Data1	P11_3	In/Out	uSD2 data
uSD2 Data2	P12_0	In/Out	uSD2 data
uSD2 Data3	P12_1	In/Out	uSD2 data
uSD2 Command	P11_1	In/Out	uSD2 CMD
uSD2 Clock	P11_0	Output	uSD2 clock
uSD2 Card Detect	P14_1	Input	0: Card present 1: No card present
uSD2 Card Power Enable	P8_1	Output	0: Power disabled 1: Power enabled
uSD2 Card IO Power Select	Not available	—	Fixed at 3.3 V

### 3.10 ADC

A right angle, 12-pin, 1.0mm pitch connector from JST (part number SM12B-SRSS-TB) is provided for connection to the RZ/G3S ADC IO.

The ADC interface voltage is 1.8 V.

Table 3.4 ADC Pin Assignment

Pin Number	Signal
1	RZ_ADC_CH0
2	RZ_ADC_CH1
3	RZ_ADC_CH2
4	RZ_ADC_CH3
5	RZ_ADC_CH4
6	RZ_ADC_CH5
7	RZ_ADC_CH6
8	RZ_ADC_CH7
9	RZ_ADC_TRG
10	ADC_AVDD (1.8 V)
11	3.3V_AWO (3.3 V)
12	Ground

### 3.11 I3C

A right angle, 4-pin, 1.0mm pitch connector from JST (part number SM04B-SRSS-TB) is provided for connection to the RZ/G3S I3C IO.

Table 3.5 I3C Pin Assignment

Pin Number	Signal
1	RZ_I3C_SCL
2	RZ_I3C_SDA
3 *1	VDD_I3C (1.2 V or 1.8 V)
4	Ground

Note 1. The I3C interface voltage is either 1.8 V (when `SW_CONFIG[4] = OFF`) or 1.2 V (when `SW_CONFIG[4] = ON`).

### 3.12 I2C

There are two I2C interfaces connected to the SMARC Edge connector.

RIIC ch0 is connected to the general purpose “I2C\_GP” interface. RIIC ch1 is connected to the power management “I2C\_PM” interface.

RIIC0 is not connected to any devices on the G3S SMARC Module.

Table 3.6 Address Mapping for RIIC1

RIIC1 Device	7-bit Address
Renesas RAA215300A2GNP#HA3 (PMIC)	0x12
Renesas GreenPAK SLG7RN46420 (logic)	0x28
Renesas GreenPAK SLG7RN46131 (logic)	0x38
Renesas 5L35023B-615NLGI (clock generator)	0x68

### 3.13 JTAG

The G3S SMARC Module JTAG interface is implemented with a 10-pin, 0.5mm pitch, FPC connector from FCI (part number 10051922-1010EHLF). All JTAG IO are 1.8 V levels.

Table 3.7 JTAG Pin Assignment

JTAG Pin Number	SMARC Specification	Module Connection
1	VDD_JTAG	VDD_XSPI (1.8 V)
2	JTAG_TRST#	JTAG_TRST#_18 *1
3	JTAG_TMS	JTAG_TMS_18
4	JTAG_TDO	JTAG_TDO_18
5	JTAG_TDI	JTAG_TDI_18
6	JTAG_TCK	JTAG_TCK_18
7	JTAG_RTCK	Not connected
8	JTAG_RESET_IN#	RZ_PRST#
9	MFG_MODE#	Not connected
10	GND	Ground

Note 1. To use the JTAG interface, RZ\_DEBUGEN must be high (**SW\_CONFIG[1] = OFF**). If RZ\_DEBUGEN is low (SW\_CONFIG[1] = ON), the TRST# pin is held low and the JTAG interface will not function.

This connector and its pinout are part of the SMARC specification, but since most JTAG tools require a 9-pin header, the Renesas SMARC JTAG Adaptor is included in the kit.

### 3.13.1 JTAG Adaptor

The flexi SMARC JTAG Adaptor is required to convert the SMARC specified FPC connection to the 9-pin Cortex debug header.



Figure 3.6 SMARC JTAG Adaptor Top View

To insert the flexi SMARC JTAG Adaptor, first open the FPC connector by lifting the tab from behind. Then insert the flexi cable and close the tab to lock it in place. Ensure the connection is square and made with the flexi contacts facing down.

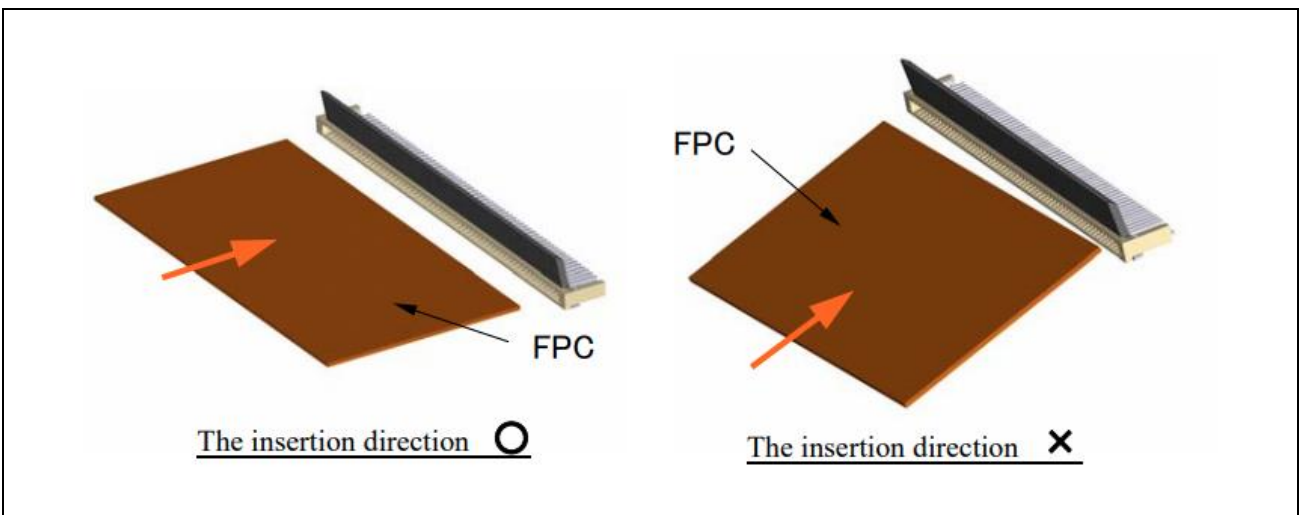

Figure 3.7 Caution When Connecting SMARC JTAG Adaptor to Connector

Table 3.8 JTAG Pin Assignment for SMARC JTAG Adaptor

Cortex 9-Pin Header Pin Number	Module Connection	Module Connection	Cortex 9-Pin Header Pin Number
1	VDD_XSPI (1.8 V)	JTAG_TMS_18	2
3	Ground	JTAG_TCK_18	4
5	Ground	JTAG_TDO_18	6
7	No pin (key)	JTAG_TDI_18	8
9 *1	Ground	RZ_PRST#	10

Note 1. By default, TRST# is not connected and pin 9 is ground. However, resistor options allow TRST# to be connected to pin 9.

### 3.14 Gigabit Ethernet Interface

Two gigabit Ethernet transceivers with RGMII support are mounted on the G3S SMARC Module.

There are RJ45 connectors to the SMARC Edge connector. Please refer to **Ethernet** for pin assignment.

### 3.15 Current Monitor

The G3S SMARC Module includes current monitoring circuitry that is accessed through the on-board micro-USB connector.

The current monitoring circuitry is powered from the USB and is completely independent of all other module and RZ/G3S functions.

A software application is required to execute on a host PC and provides current measurements for

- 0.9V\_AWO
- 0.9V\_ISO
- 1.1V\_DDR
- 1.8V\_DDR
- VBAT\_VDD

Table 3.9 I2C Address Mapping for Current Monitoring

Device	7-bit Address
Renesas ISL28025FR12Z(0.9V_AWO)	0xa0
Renesas ISL28025FR12Z(0.9V_ISO)	0x84
Renesas ISL28025FR12Z(1.1V_DDR)	0x86
Renesas ISL28025FR12Z(1.8V_DDR)	0x9c
Renesas ISL28025FR12Z(VBAT_VDD)	0x9e

## 3.16 SMARC Edge Connector

The SMARC edge connector has a Primary side (Pxx) and Secondary side (Sxx). The SMARC signal names and edge connector pin numbers are listed in the tables below along with the RZ/G3S port pin (if applicable) and signal name. The default settings are **highlighted**.

### 3.16.1 Display Interfaces

The RZG3S does not support any display interfaces. None of the display signals are connected.

### 3.16.2 Camera Interfaces

The RZG3S does not support any camera interfaces. None of the camera signals are connected.

### 3.16.3 SDIO Card (4 bit) Interface

The SDIO signal is routed to the SMARC Edge Connector.

Table 3.10 SDIO Signals

SMARC Signal Name	Pin #	RZ Port Pin	Signal
SDIO_D0	P39	SD1_DATA0	RZ_SD1_D0
SDIO_D1	P40	SD1_DATA1	RZ_SD1_D1
SDIO_D2	P41	SD1_DATA2	RZ_SD1_D2
SDIO_D3	P42	SD1_DATA3	RZ_SD1_D3
SDIO_WP	P33	—	Not connected
SDIO_CMD	P34	SD1_CMD	RZ_SD1_CMD
SDIO_CD#	P35	P0_2	RZ_SD1_CD#
SDIO_CLK	P36	SD1_CLK	RZ_SD1_CLK
SDIO_PWR_EN	P37	P2_3	RZ_SDIO_PWR_EN

### 3.16.4 SPI Interfaces

The SPI1 signal is routed to the SMARC Edge Connector.

The SPI0 signal is not connected to the SMARC Edge Connector.

Table 3.11 SPI0 and SPI1 Signals

SMARC Signal Name	Pin #	RZ Port Pin	Signal
SPI0_CS0#	P43	—	Not connected
SPI0_CS1#	P31	—	Not connected
SPI0_CK	P44	—	Not connected
SPI0_DIN	P45	—	Not connected
SPI0_DO	P46	—	Not connected
SPI1_CS0#	P54	P15_3	RZ_RSPI0_SSL
SPI1_CS1#	P55	—	Not connected
SPI1_CK	P56	P15_0	RZ_RSPI0_CK
SPI1_DIN	P57	P15_2	RZ_RSPI0_MISO
SPI1_DO	P58	P15_1	RZ_RSPI0_MOSI

### 3.16.5 Audio

These signals are routed to the SMARC Edge Connector.

Table 3.12 I2S0 and I2S2 Signals

SMARC Signal Name	Pin #	RZ Port Pin	Signal
I2S0_LRCK	S39	P18_3	RZ_SSI3_RCK
I2S0_SDOUT	S40	P18_4	RZ_SSI3_TXD
I2S0_SDIN	S41	P18_5	RZ_SSI3_RXD
I2S0_CK	S42	P18_2	RZ_SSI3_BCK
AUDIO_MCK	S38	N/A	AUDIO_MCK (clock generator)
I2S2_LRCK *1	S50	P11_1	RZ_SSI0_RCK
		—	Not connected
I2S2_SDOUT *1	S51	P11_2	RZ_SSI0_TXD
		—	Not connected
I2S2_SDIN *1	S52	P11_3	RZ_SSI0_RXD
		—	Not connected
I2S2_CK *1	S53	P11_0	RZ_SSI0_BCK
		—	Not connected
AUDIO_MCK	S38	N/A	AUDIO_MCK (clock generator)

Note 1. SW\_CONFIG[3] switch option on the G3S SMARC Module



### 3.16.6 I2C Interfaces

The I2C\_GP and I2C\_PM signals are routed to the SMARC Edge Connector.

The I2C\_CAM0, I2C\_CAM1, and I2C\_LCD signals are not connected to the SMARC Edge Connector.

Table 3.13 I2C\_GP and I2C\_PM Signals

SMARC Signal Name	Pin #	RZ Port Pin	Signal
I2C_GP_CK	S48	RIIC0_SCL	RZ_RIIC0_SCL
I2C_GP_DAT	S49	RIIC0_SDA	RZ_RIIC0_SDA
I2C_PM_CK	P121	RIIC1_SCL	RZ_RIIC1_SCL
I2C_PM_DAT	P122	RIIC1_SDA	RZ_RIIC1_SDA

#### NOTE

RZ\_RIIC1 bus is also used on the G3S SMARC Module itself for:

- Power/Reset Control: SLG7RN46131
- PMIC: RAA215300A2GNP#HA3
- Power Regulator: SLG7RN46420
- Clock Generator: 5L35023B-615NLGI

### 3.16.7 Asynchronous Serial Ports

The SER0, SER1, and SER3 signals are routed to the SMARC Edge Connector.

The SER2 signal is not connected to the SMARC Edge Connector.

Table 3.14 SER0, SER2t, and SER3 Signals

SMARC Signal Name	Pin #	RZ Port Pin	Signal
SER0_TX	P129	P14_0	RZ_SCIF1_TXD
SER0_RX *1	P130	P14_1	RZ_SCIF1_RXD
		—	Not connected
SER0_RTS#	P131	P16_1	RZ_SCIF1_RTS#
SER0_CTS#	P132	P16_0	RZ_SCIF1_CTS#
SER1_TX	P134	P17_3	RZ_SCIF3_TXD
SER1_RX	P135	P17_2	RZ_SCIF3_RXD
SER2_TX	P136	—	Not connected
SER2_RX	P137	—	Not connected
SER2_RTS#	P138	—	Not connected
SER2_CTS#	P139	—	Not connected
SER3_TX	P140	P6_4	RZ_SCIF0_TXD
SER3_RX	P141	P6_3	RZ_SCIF0_RXD

Note 1. SW\_CONFIG[3] switch option on the G3S SMARC Module

### 3.16.8 CAN Bus

These signals are routed to the SMARC Edge Connector.

Table 3.15 CAN0 and CAN1 Signals

SMARC Signal Name	Pin #	RZ Port Pin	Signal
CAN0_TX	P143	P6_1	RZ_CAN0_TX
CAN0_RX	P144	P6_2	RZ_CAN0_RX
CAN1_TX	P145	P17_0	RZ_CAN1_TX
CAN1_RX	P146	P17_1	RZ_CAN1_RX

### 3.16.9 USB Interfaces

The USB channel 0 and 1 signals are routed to the SMARC Edge Connector.

The USB channel 2, 3, 4, and 5 signals are not connected to the SMARC Edge connector.

Table 3.16 USB0 and USB1 Signals

SMARC Signal Name	Pin #	RZ Port Pin	Signal
USB0+	P60	—	RZ_USB0_DP
USB0-	P61	—	RZ_USB0_DM
USB0_EN_OC# *	P62	P5_0	RZ_USB0_VBUSEN
		P5_2	RZ_USB0_OVRCUR#
USB0_VBUS_DET	P63	—	RZ_USB0_VBUSIN
USB0_OTG_ID	P64	P5_3	RZ_USB0_OTG_ID
USB1+	P65	—	RZ_USB1_DP
USB1-	P66	—	RZ_USB1_DM
USB1_EN_OC# * <sup>1</sup>	P67	P6_0	RZ_USB1_VBUSEN
		P5_4	RZ_USB1_OVRCUR#

Note 1. Logic circuitry is used to provide independent enable and overcurrent IO.

### 3.16.10 PCI Express

The PCIE\_A signal is routed to the SMARC Edge Connector.

The PCIE\_B, PCIE\_C, and PCIE\_D signals are not connected to the SMARC Edge Connector.

Table 3.17 PCIE\_A Signals

SMARC Signal Name	Pin #	RZ Port Pin	Signal
PCIE_A_TX+	P89	—	PCIE_A_TX+
PCIE_A_TX-	P90	—	PCIE_A_TX-
PCIE_A_RX+	P86	—	PCIE_A_RX+
PCIE_A_RX-	P87	—	PCIE_A_RX-
PCIE_A_REFCK+	P83	—	RZ_PCIE_REFCLK+
PCIE_A_REFCK-	P84	—	RZ_PCIE_REFCLK-
PCIE_A_RST#	P75	P13_2	PCIE_A_RST#
PCIE_A_CKREQ#	P78	P13_3	PCIE_A_CKREQ#

### 3.16.11 SATA

The RZG3S does not support SATA interfaces. None of the SATA signals are connected.

### 3.16.12 Ethernet

These signals are routed to the SMARC Edge Connector.

Table 3.18 GBE0 and GBE1 Signals

SMARC Signal Name	Pin #	RZ Port Pin	Signal
GBE0_MDI0+	P30	—	These signals are provided by the Ethernet PHY controlled by the RZ RGMII signals ET0_xxx
GBE0_MDI0-	P29	—	
GBE0_MDI1+	P27	—	
GBE0_MDI1-	P26	—	
GBE0_MDI2+	P24	—	
GBE0_MDI2-	P23	—	
GBE0_MDI3+	P20	—	
GBE0_MDI3-	P19	—	
GBE0_LINK100#	P21	N/A	
GBE0_LINK1000#	P22	N/A	ET0_LED2 (ET0 PHY)
GBE0_LINK_ACT#	P25	N/A	ET0_LED1 (ET0 PHY)
GBE0_CTREF	P28	—	Not connected
GBE0_SDP	P6	—	Not connected
Ethernet PHY0 Interrupt *1	n/a	P12_0	ET0_INT# (RZ_IRQ0)
		—	Not connected
GBE1_MDI0+	S17	—	These signals are provided by the Ethernet PHY controlled by the RZ RGMII signals ET1_xxx
GBE1_MDI0-	S18	—	
GBE1_MDI1+	S20	—	
GBE1_MDI1-	S21	—	
GBE1_MDI2+	S23	—	
GBE1_MDI2-	S24	—	
GBE1_MDI3+	S26	—	
GBE1_MDI3-	S27	—	
GBE1_LINK100#	S19	N/A	
GBE1_LINK1000#	S22	N/A	ET1_LED2 (ET1 PHY)
GBE1_LINK_ACT#	S31	N/A	ET1_LED1 (ET1 PHY)
GBE1_CTREF	S28	—	Not connected
GBE1_SDP	P5	—	Not connected
Ethernet PHY1 Interrupt *1	n/a	P12_1	ET1_INT# (RZ_IRQ1)
		—	Not connected

Note 1. SW\_CONFIG[3] switch option on the G3S SMARC Module

### 3.16.13 GPIO

Table 3.19 GPIO Signals

SMARC Signal Name	Pin #	RZ Port Pin	Signal
GPIO0	P108	—	Not connected
GPIO1	P109	—	Not connected
GPIO2	P110	—	Not connected
GPIO3	P111	—	Not connected
GPIO4 *1	P112	P18_0	RZ_IRQ2_GPIO4
		TAMPIN	RZ_TAMPIN
GPIO5	P113	P13_4	RZ_P13_4_GPIO5
GPIO6	P114	P0_1	RZ_P0_1_GPIO6
GPIO7	P115	P0_3	RZ_P0_3_GPIO7
GPIO8	P116	P13_0	RZ_P13_0_GPIO8
GPIO9	P117	P13_1	RZ_P13_1_GPIO9
GPIO10	P118	P18_1	RZ_IRQ3_GPIO10
GPIO11	P119	P14_2	RZ_P14_2_GPIO11
GPIO12	S142	P8_2	RZ_P8_2_GPIO12
GPIO13	S123	P8_3	RZ_P8_3_GPIO13

Note 1. GPIO4\_SEL switch option on the G3S SMARC Module

REVISION HISTORY	RZ Family / RZ/G Series RZ/G3S SMARC Module Board
------------------	--

Rev.	Date	Description	
		Page	Summary
1.00	Nov. 14, 2023	—	First edition issued
1.10	Nov. 20, 2024	All	As RZ/G3S SMARC EVK, RTK9845S37S01000BE which is equipped with R9A08G045S37GBG (for which the security is supported) was added.
		13	Figure 2.3 was modified.
		14, 15	Table 2.1 was modified.
		18	Table 2.4 was modified.
		20	Figure 3.1 was modified.
		21	Figure 3.2 was added.
		22	Figure 3.3 was added.
		23	Figure 3.4 was modified.
		24	Figure 3.5 was modified.

---

RZ/G3S SMARC Module Board

Publication Date:   Rev.1.00   Nov. 14, 2023  
                          Rev.1.10   Nov. 20, 2024

Published by:       Renesas Electronics Corporation

---

# RZ Family / RZ/G Series