

ZL8800-2CH-DEMO1Z

Demonstration Board

AN1877

Rev 2.00

December 19, 2014

The ZL8800 is a digital power conversion and management IC that combines an efficient step-down DC/DC converter with key power and thermal management functions in a single package. The ZL8800 incorporates compensation-free ChargeMode™ control to achieve single-cycle transient response.

The ZL8800-2CH-DEMO1Z demonstration board is a 6-layer board demonstrating 2 independent 30A synchronous buck converters. Sequencing, tracking, margining, plus other features can be evaluated using this board.

A USB to PMBus™ adapter board is used to connect the demonstration board to a PC. The PMBus command set is accessed by using the Intersil PowerNavigator™ evaluation software from a PC running Microsoft Windows.

Key Features

- 2 independent 30A synchronous buck converters with compensation-free ChargeMode control
- Designed to be easy to use and modify. Optimized for small circuit footprint and dynamic response
- Configurable through PMBus
- $V_{IN}$  range of 6.5V to 14V,  $V_{OUT}$  adjustable from 0.54 to 5.5V
- Enable switches and power-good indicators

Ordering Information

PART NUMBER	DESCRIPTION
ZL8800-2CH-DEMO1Z	ZL8800 Demonstration Kit (EVB, USB Adapter, Cable)

Target Specifications

- $V_{IN} = 12V$
- $V_{OUT} = 1.2V/30A$  max and  $1.0V/30A$  max
- $f_{SW} = 512kHz$
- Efficiency: 91% at 20A
- Output Ripple:  $\pm 1\%$
- Dynamic response:  $\pm 1\%$  (50% to 100% to 50% load step,  $di/dt = 10A/\mu s$ )
- Board temperature:  $+25^{\circ}C$

Functional Description

The ZL8800-2CH-DEMO1Z provides all circuitry required to demonstrate the features of the ZL8800. The ZL8800-2CH-DEMO1Z has a functionally-optimized ZL8800 circuit layout that allows efficient operation up to the maximum output current.

A majority of the features of the ZL8800, such as compensation-free ChargeMode control, soft-start delay and ramp times, supply sequencing, voltage tracking and voltage margining are available on this demonstration board. For voltage tracking and sequencing demonstration, the board can be connected to any other Intersil demonstration board that supports the Digital-DC™ (DDC) bus.

Figure 1 shows a simplified schematic diagram of the ZL8800-2CH-DEMO1Z board.

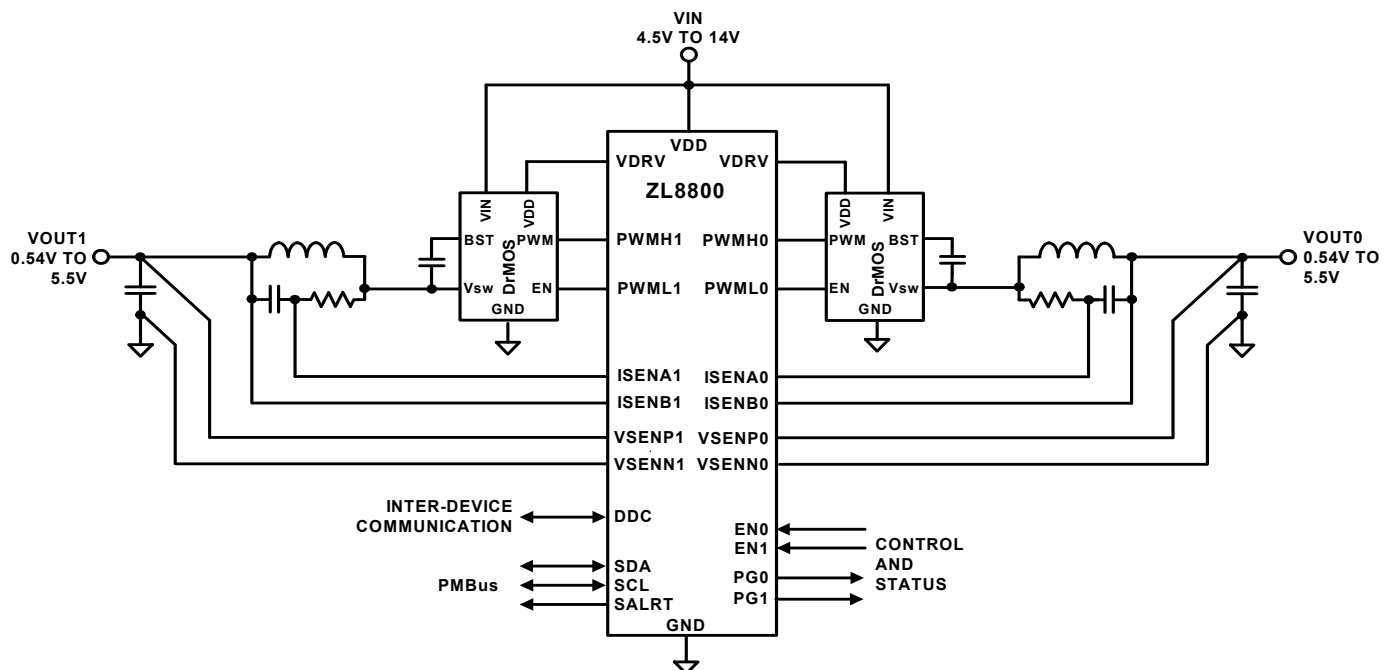

FIGURE 1. ZL8800-2CH-DEMO1Z SIMPLIFIED SCHEMATIC

The hardware enable function is controlled by toggle switches on the ZL8800-2CH-DEMO1Z board. The power-good (PG) LEDs indicate the correct state of PG when external power is applied to the ZL8800-2CH-DEMO1Z board and the corresponding output is functioning properly. The right angle headers at opposite ends of the board are for connecting a USB to PMBus adapter board or for daisy chaining multiple demonstration boards together to build multioutput configurations.

[Figures 2](#) and [3](#) show the detailed demonstration circuit. [Figure 2](#) shows the ZL8800 IC with its minimal component count to realize a 30A output on each buck converter. [Figure 3](#) has interface circuitry unique to the demonstration board that is not typically contained in a user's application circuit. [Figures 4](#) through [10](#) show typical performance data and [Figures 15](#) through [22](#) demonstrate the PCB board layout, which include the board fabrication notes. The default configuration file is shown on [page 6](#), and the Bill of Materials (BOM) is included for reference beginning on [page 5](#).

## References

[ZL8800](#) Datasheet, "Dual Channel/Dual Phase PMBus™ ChargeMode Control DC/DC Digital Controller"

## Operation

### PMBus Operation

The ZL8800 utilizes the PMBus protocol. The PMBus functionality can be controlled via USB from a PC running the PowerNavigator evaluation software in a Windows XP, Windows 7 or Windows 8 operating systems.

Install the evaluation software from the following Intersil website:

<http://www.intersil.com/powernavigator.html>

For board operation, connect the included USB-to-PMBus adapter board to J8 of the ZL8800-2CH-DEMO1Z board labeled "DONGLE". Connect the desired load and an appropriate power supply to the input and connect the included USB cable to the PC running the PowerNavigator evaluation software. Place the ENABLE switches in "DISABLE" and turn on the power.

The evaluation software allows modification of all ZL8800 PMBus parameters. The ZL8800 device on the board has been preconfigured as described in this document, but the user may modify the operating parameters through the evaluation software or by loading a predefined set-up from a configuration file.

The ENABLE switch can then be moved to "ENABLE" and the ZL8800-2CH-DEMO1Z board can be tested. Alternately, the PMBus ON\_OFF\_CONFIG and OPERATION commands may be used from the PowerNavigator GUI.

## Quick Start Guide

### Stand-Alone Operation

1. Set ENABLE switch to "DISABLE".
2. Apply load to VOUT0 and/or VOUT1.
3. Connect the USB to PMBus adapter board to J8 (labeled "DONGLE") of ZL8800-2CH-DEMO1Z.
4. Connect supplied USB cable from computer to USB to PMBus adapter board.
5. Connect power supply to VIN (supply turned off).
6. Turn power supply on.
7. Set ENABLE switch to "ENABLE".
8. Monitor ZL8800-2CH-DEMO1Z board operation using an oscilloscope.

### USB (PMBus) Operation

1. Set ENABLE switch to "DISABLE".
2. Apply load to VOUT and/or VOUT1.
3. Connect power supply to VIN (supply turned off).
4. Turn power supply on.
5. Connect USB to PMBus adapter board to J8 of ZL8800-2CH-DEMO1Z.
6. Connect supplied USB cable from computer to USB to PMBus adapter board.

Install the PowerNavigator evaluation software from the following Intersil website:

<http://www.intersil.com/powernavigator.html>.

7. Set ENABLE switch to "ENABLE".
8. Monitor and configure the ZL8800-2CH-DEMO1Z board using PMBus commands in the evaluation software.
9. Test the ZL8800-2CH-DEMO1Z operation using an oscilloscope and the evaluation software.



# ZL8800-2CH-DEMO1Z Board Schematics (Continued)

## BOARD TO BOARD INTERFACE

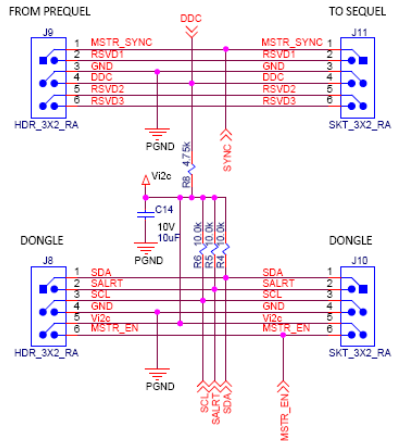

## POWER GOOD

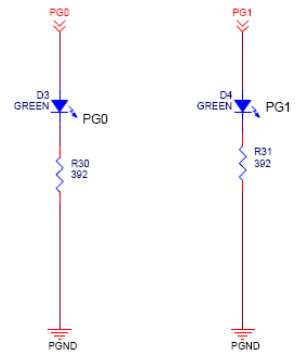

## DRIVER SUPPLY

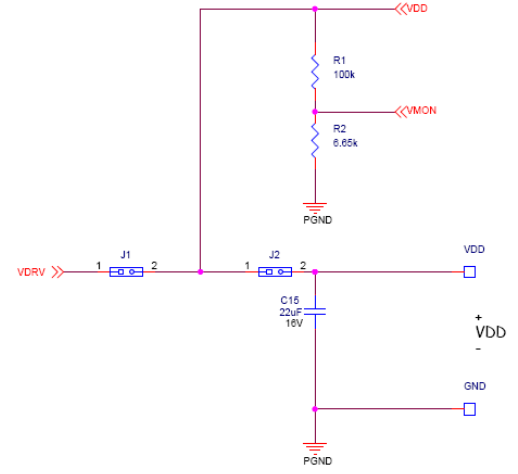

## TRACKING

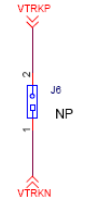

## ENABLE

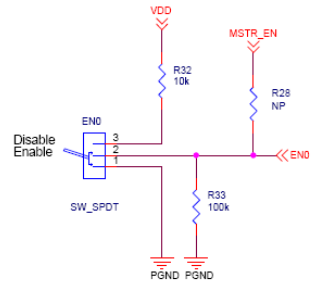

## ENABLE

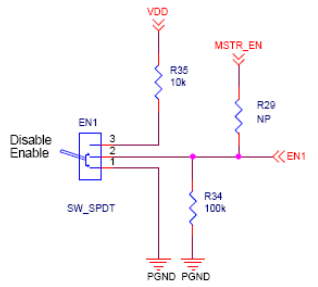

## INPUT CONNECTOR

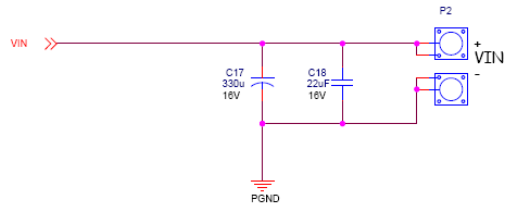

FIGURE 3. ZL8800-2CH-DEMO1Z AUXILIARY CIRCUITRY

## ZL8800-2CH-DEMO1Z Bill of Materials

QTY	REFERENCE	VALUE	TOL	RATING	TYPE	PCB FOOTPRINT	MFR	PART NUMBER
1	U2	ZL8800	-	14V	-	MLF44_7X7_XX	Intersil	ZL8800ALAF7K
8	C1, C2, C3, C5, C6, C7, C8, C9	100µF	20%	6.3V	X5R	SM1210	Taiyo Yuden	JMK325BJ107MY-T
4	C4, C10, C11, C12	470µF	20%	2V	AL	SM7343P	Panasonic	EEF-SX0D471E4
4	C13, C20, C29, C16	10µF	10%	10V	X5R	SM0805	Taiyo Yuden	LMK212B7106KG-TD
9	C18, C22, C23, C24, C25, C30, C31, C32, C33	22µF	20%	16V	X5R	SM1206	Murata	GRM31CR61C226ME15L
1	C17	330µ	20%	16V	AL POLY	SM_CAP_10.5X10.5	United Chemi	APXA160ARA331MJC0G
4	C19, C26, C28, C35	1µF	10%	16V	X7R	SM0603	TDK	C1608X7R1C105K
2	C27, C36	100p	5%	50V	NPO	SM0402_WSS	Murata	GRM1555C1H101JZ01D
6	C38, C39, C41, C37, C21, C34	10µ	20%	16V	X5R	SM0603	Taiyo Yuden	EMK107BBJ106MA-T
1	C40	2.2µ	10%	25V	X5R	SM0805	Murata	GRM21BR71E225KA73L
2	L1, L2	0.27µH	-	35.5A	FERRITE	IND_SLC1175	Coil Craft	SLC1175-271ME_
2	Q3, Q6	FDMF5821	-	60A/20V	DR MOS	PQFN31_5X5_P5S	Fairchild	FDMF5821DC
2	Q2, Q4	2N3904	-	40V	NPN	SOT-23	ON Semi	MMBT3904LT1G
2	R1, R26	100k	1%	100mW	THK FILM	SM0603	Panasonic	ERJ-3EKF1003V
1	R2	6.65k	1%	100mW	THK FILM	SM0603	Panasonic	ERJ-3EKF6651V
2	R3, R7	100	1%	100mW	THK FILM	SM0805	Panasonic	ERJ-6ENF1000V
2	R9, R11	1	5%	100mW	THK FILM	SM0603	Rohm	MCR03EZPJ1R0
2	R10, R12	1.40k	1%	100mW	THK FILM	SM0603	Panasonic	ERJ-3EKF1401V
1	R18	28.7k	1%	100mW	THK FILM	SM0402	Panasonic	ERJ-3EKF2872V
1	R25	31.6k	1%	100mW	THK FILM	SM0603	Panasonic	ERJ-3EKF3162V
1	R27	147k	1%	100mW	THK FILM	SM0603	Panasonic	ERJ-3EKF1473V
2	R14, R13	3.3Ω	5%	100mW	THK FILM	SM0603	Panasonic	ERJ-3GEYJ3R3V
2	R15, R16	30k	5%	100mW	THK FILM	SM0603	Panasonic	ERJ-3GEYJ303V
<b>DEMONSTRATION BOARD SPECIFIC AUXILIARY PARTS BILL OF MATERIALS</b>								
1	VDD	Terminal	-	Red	Test Point	TP_036H_SSREF	Keystone	5000
1	GND	Terminal	-	Black	Test Point	TP_036H_SSREF	Keystone	5001
2	D3, D4	GREEN	-	2V, 20mA	LED	SM0805	Chicago Mini	CMD17-21VGC/TR8
2	EN1, EN0	SW_SPDT	-	-	PCB VERT	SW_TOG_SPDT	NKK	G12AP
4	J1, J2, J105, J106	2 POS	-	-	VERT	SIP2/100	Samtec	TSW-102-07-L-S
1	J6	Not Used	-	-	-	-	-	-
2	J8, J9	Header	-	-	RA	HDRM3DUALRA	Samtec	TSW-103-08-T-D-RA
2	J10, J11	Socket	-	-	RA	HDRF3DUALRA	Samtec	SSQ-103-02-T-D-RA
4	J101, J102, J103, J104	Terminal	-	-	-	JACK_F_175	Burndy	KPA8CTP
2	P2	Banana Jack	-	15A	-	JACK_F_NI_2P	Emerson	108-0740-001
2	R30, R31	392	1%	100mW	THK FILM	SM0603	Yageo	RC0603FR-07393RL
1	C15	22µF	20%	16V	X5R	SM1206	Murata	GRM31CR61C226ME15L
5	R4, R5, R6, R32, R35	10.0k	1%	63mW	THK FILM	SM0603	Panasonic	ERJ-2RKF1002X
2	R33, R34	100k	1%	100mW	THK FILM	SM0603	Panasonic	ERJ-3EKF1003V
3	R24, R28, R29	Not Used	-	-	-	SM0603	-	-
1	R8	4.75k	1%	100mW	THK FILM	SM0603	Panasonic	ERJ-2RKF4751X
1	C14	10µF	10%	10V	X5R	SM1206	Murata	GRM31CR61C106ME15L

## Configuration File

The following text is loaded into the ZL8800 device on the ZL8800-2CH-DEMO1Z as default settings. Each PMBus command is loaded via the PowerNavigator software. The # symbol is used for a comment line.

# Initialize device to factory settings

```
RESTORE_FACTORY
STORE_DEFAULT_ALL
STORE_USER_ALL
```

```
### Begin Default Store
RESTORE_DEFAULT_ALL
```

# Global commands

# PAGE 0 commands

```
PAGE 0x0
VOUT_MAX 0x4000 # 2 V
IOUT_CAL_GAIN 0xb11e # 0.279 mV/A
IOUT_OC_FAULT_LIMIT 0xe370 # 55 A
IOUT_UC_FAULT_LIMIT 0xe490 # -55 A
USER_CONFIG 0x786
INDUCTOR 0xb114 # 0.27 uH
TEMPCO_CONFIG 0xa7
DDC_GROUP 0x0
IOUT_AVG_OC_FAULT_LIMIT 0xe230 # 35 A
IOUT_AVG_UC_FAULT_LIMIT 0xe5d0 # -35 A
MFR_VMON_OV_FAULT_LIMIT 0xcb00 # 6 V
MFR_VMON_UV_FAULT_LIMIT 0xca00 # 4 V
```

# PAGE 1 commands

```
PAGE 0x1
VOUT_COMMAND 0x2000 # 1 V
VOUT_MAX 0x4000 # 2 V
VOUT_MARGIN_HIGH 0x219a # 1.05 V
VOUT_MARGIN_LOW 0x1e66 # 0.95 V
IOUT_CAL_GAIN 0xb11e # 0.279 mV/A
VOUT_OV_FAULT_LIMIT 0x235c # 1.105 V
VOUT_UV_FAULT_LIMIT 0x1ca4 # 0.895 V
IOUT_OC_FAULT_LIMIT 0xe370 # 55 A
IOUT_UC_FAULT_LIMIT 0xe490 # -55 A
POWER_GOOD_ON 0x1ccd # 0.9 V
USER_CONFIG 0x7a6
INDUCTOR 0xb114 # 0.27 uH
TEMPCO_CONFIG 0xa7
IOUT_AVG_OC_FAULT_LIMIT 0xe230 # 35 A
IOUT_AVG_UC_FAULT_LIMIT 0xe5d0 # -35 A
MFR_VMON_OV_FAULT_LIMIT 0xcb00 # 6 V
MFR_VMON_UV_FAULT_LIMIT 0xca00 # 4 V
```

```
STORE_DEFAULT_ALL
### End Default Store
```

```
### Begin User Store
RESTORE_USER_ALL
```

# Global commands

```
# PAGE 0 commands
PAGE 0x0
```

```
# PAGE 1 commands
PAGE 0x1
```

```
STORE_USER_ALL
### End User Store
```

# Measured Data

The following data was acquired using a ZL8800-2CH-DEMO1Z Rev B demonstration board.

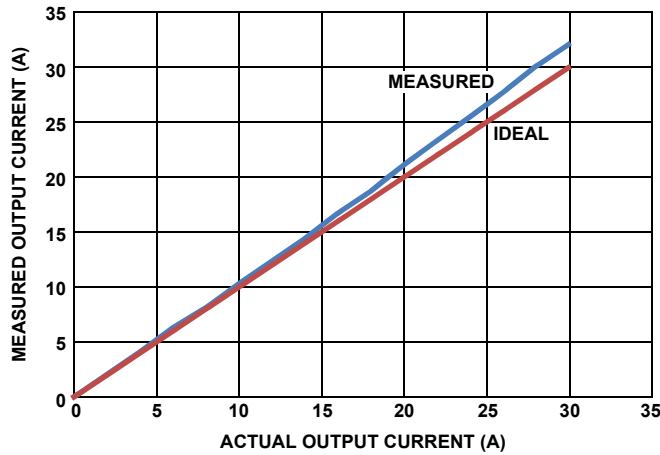

FIGURE 4. OUTPUT CURRENT MEASUREMENT ACCURACY

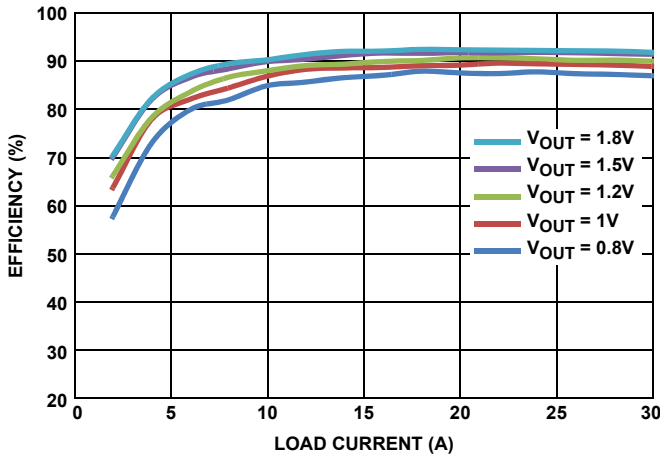

FIGURE 5. EFFICIENCY,  $V_{IN} = 12V$ ,  $f_{SW} = 300kHz$

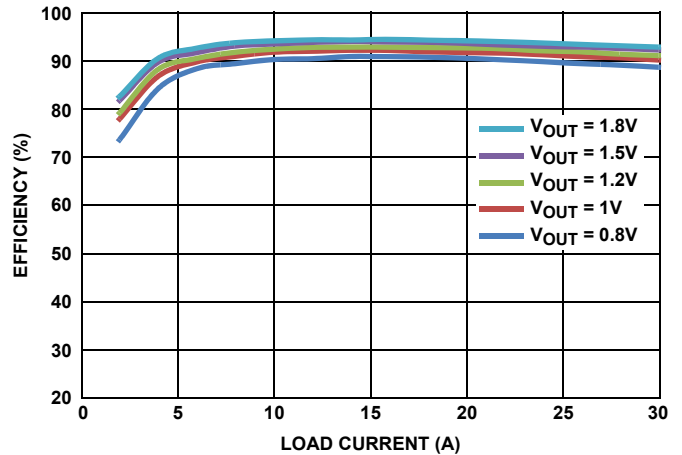

FIGURE 6. EFFICIENCY,  $V_{IN} = 5V$ ,  $f_{SW} = 300kHz$

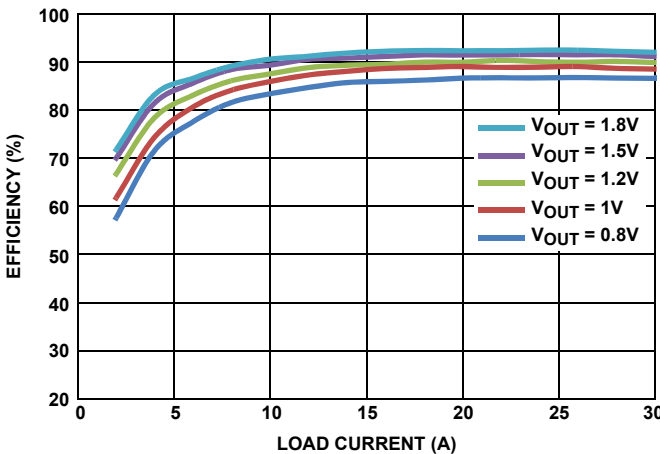

FIGURE 7. EFFICIENCY,  $V_{IN} = 12V$ ,  $f_{SW} = 400kHz$

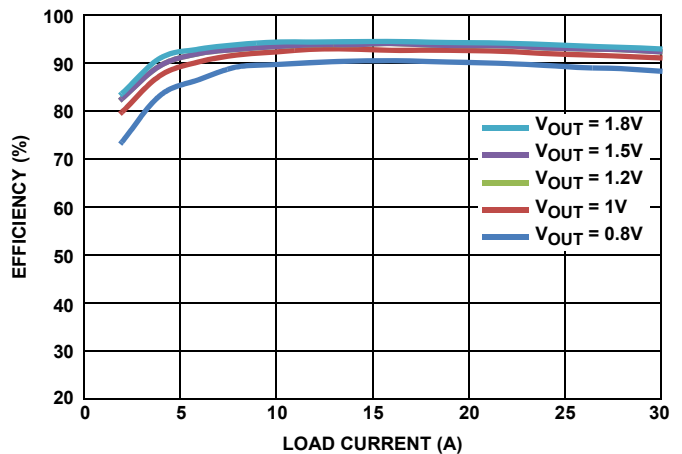

FIGURE 8. EFFICIENCY,  $V_{IN} = 5V$ ,  $f_{SW} = 400kHz$

**Measured Data** The following data was acquired using a ZL8800-2CH-DEMO1Z Rev B demonstration board. (Continued)

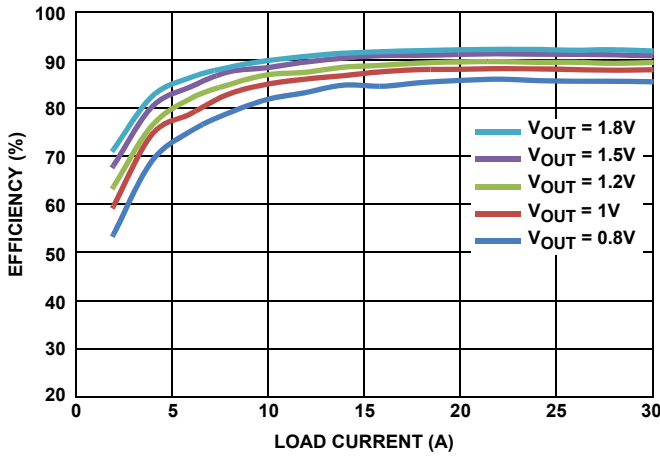

FIGURE 9. EFFICIENCY, V<sub>IN</sub> = 12V, f<sub>SW</sub> = 516kHz

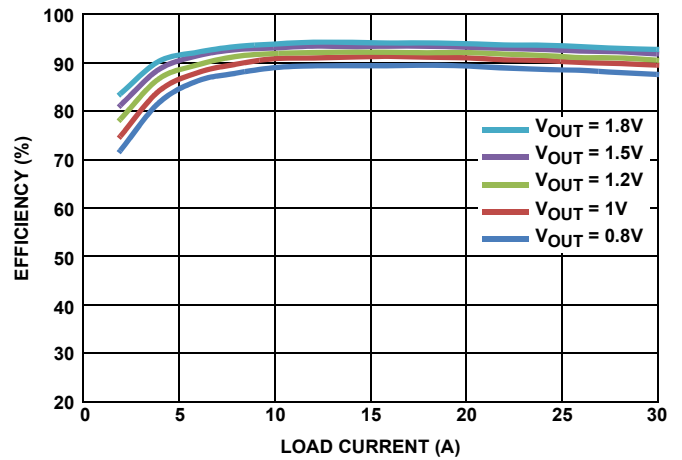

FIGURE 10. EFFICIENCY, V<sub>IN</sub> = 5V, f<sub>SW</sub> = 516kHz



FIGURE 11. RAMP UP



FIGURE 12. RAMP DOWN

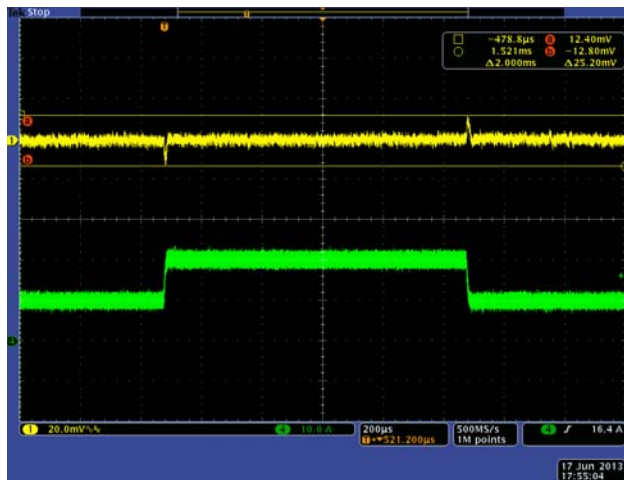

FIGURE 13. STEP RESPONSE, 10A TO 20A AT 5A/µs, ASCR = 1000  
TOTAL DEVIATION WINDOW 25mV = 2.5%

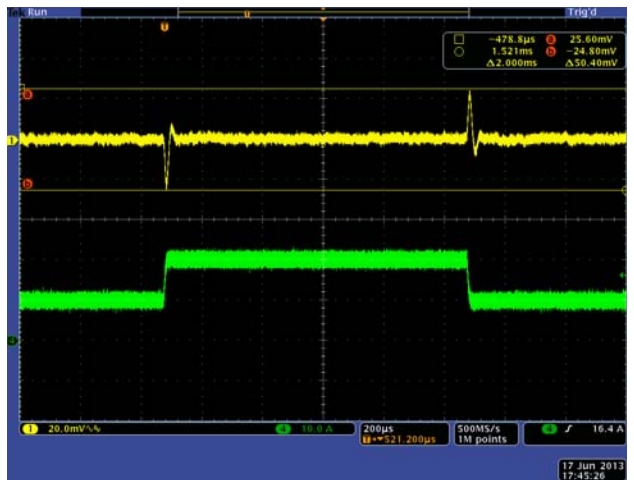

FIGURE 14. STEP RESPONSE, 10A TO 20A AT 5A/µs, ASCR = 400  
TOTAL DEVIATION WINDOW 50mV = 5%



## **ZL8800-2CH-DEMO1Z Board Layout**

**FIGURE 15. PCB - TOP ASSEMBLY**

## ZL8800-2CH-DEMO1Z Board Layout (Continued)

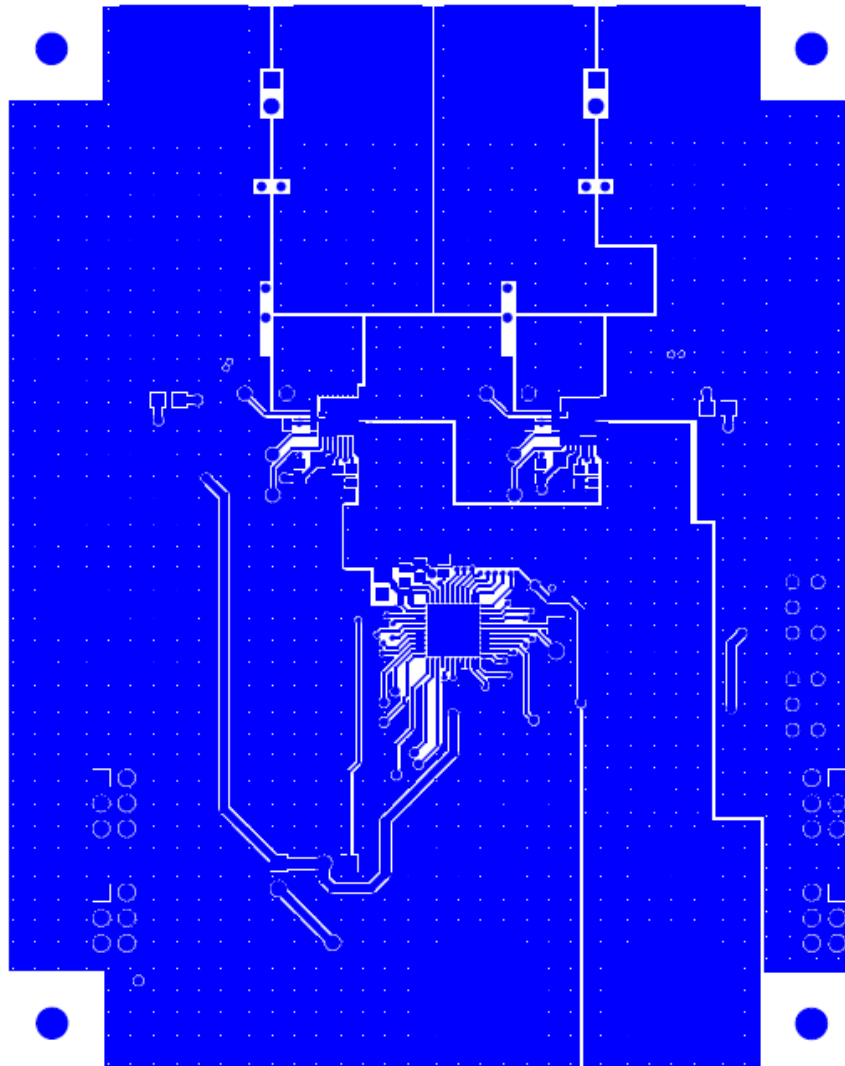

FIGURE 16. PCB - TOP LAYER

## ZL8800-2CH-DEMO1Z Board Layout (Continued)

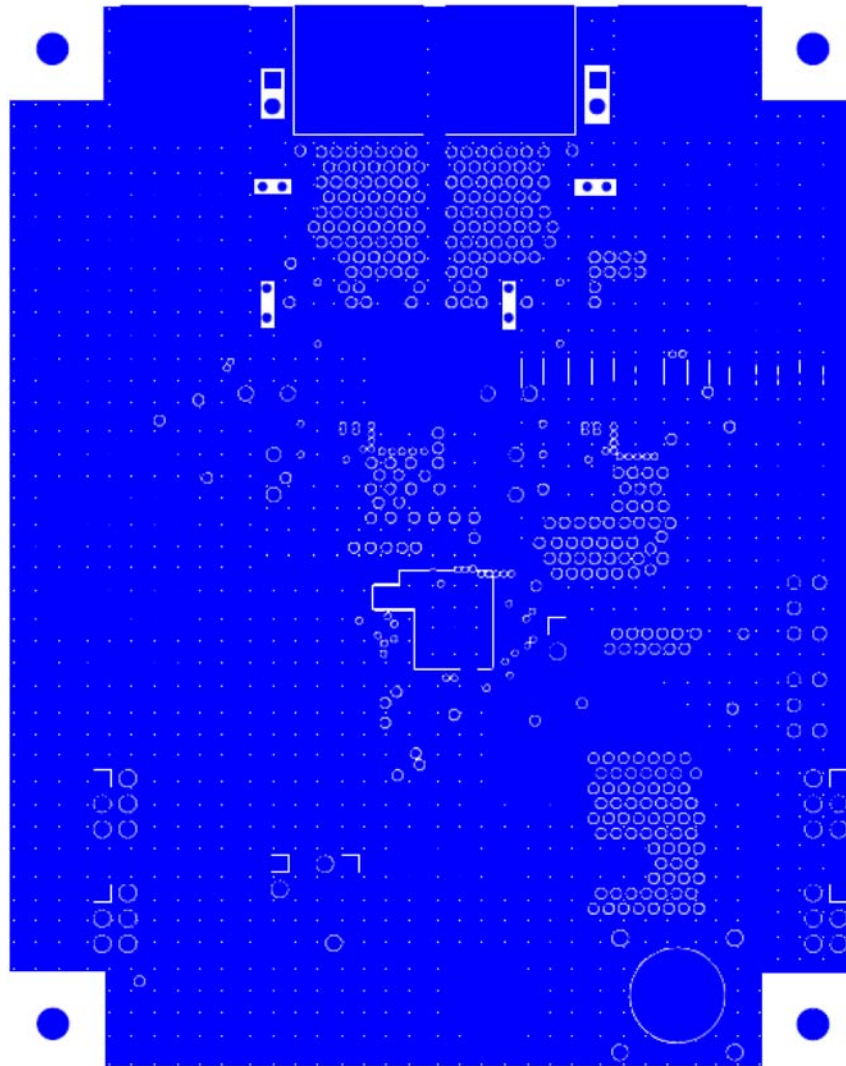

FIGURE 17. PCB - INNER LAYER 1 (TOP VIEW)

## ZL8800-2CH-DEMO1Z Board Layout (Continued)

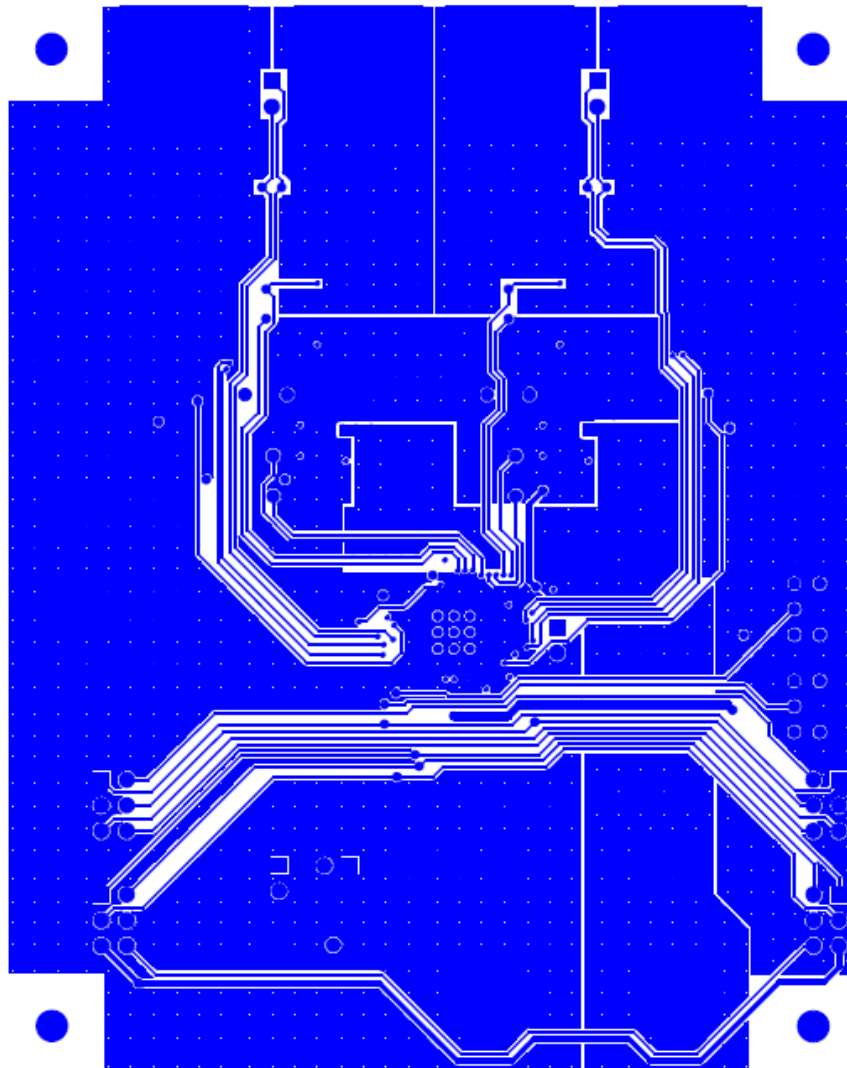

FIGURE 18. PCB - INNER LAYER 2 (TOP VIEW)

## ZL8800-2CH-DEMO1Z Board Layout (Continued)

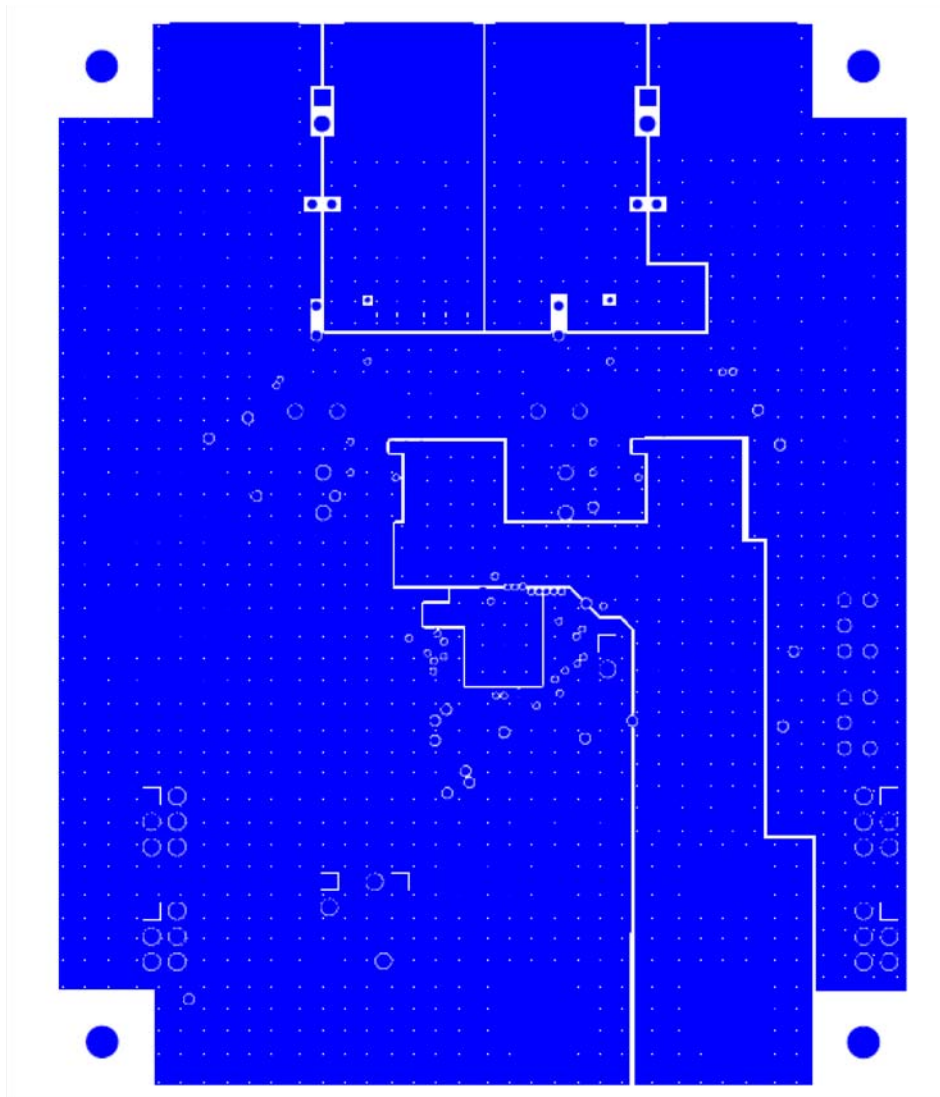

FIGURE 19. PCB - INNER LAYER 3 (TOP VIEW)

## ZL8800-2CH-DEMO1Z Board Layout (Continued)

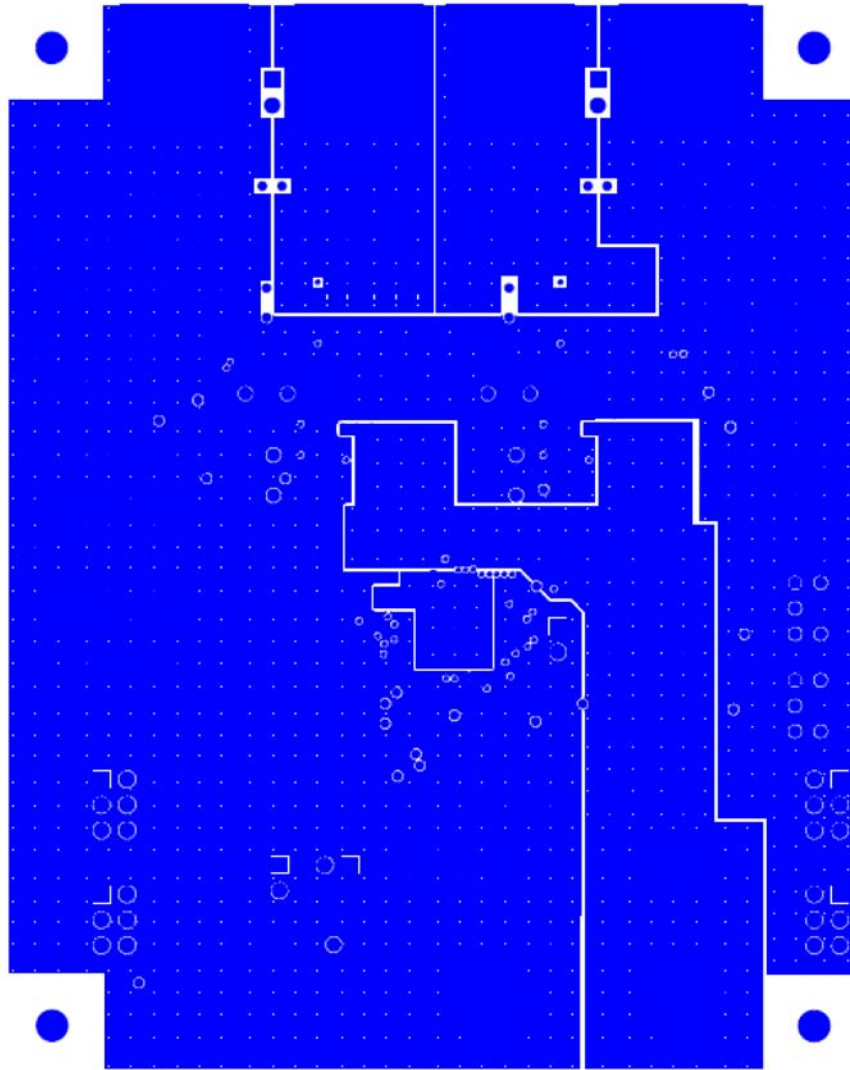

FIGURE 20. PCB - INNER LAYER 4 (TOP VIEW)

## ZL8800-2CH-DEMO1Z Board Layout (Continued)

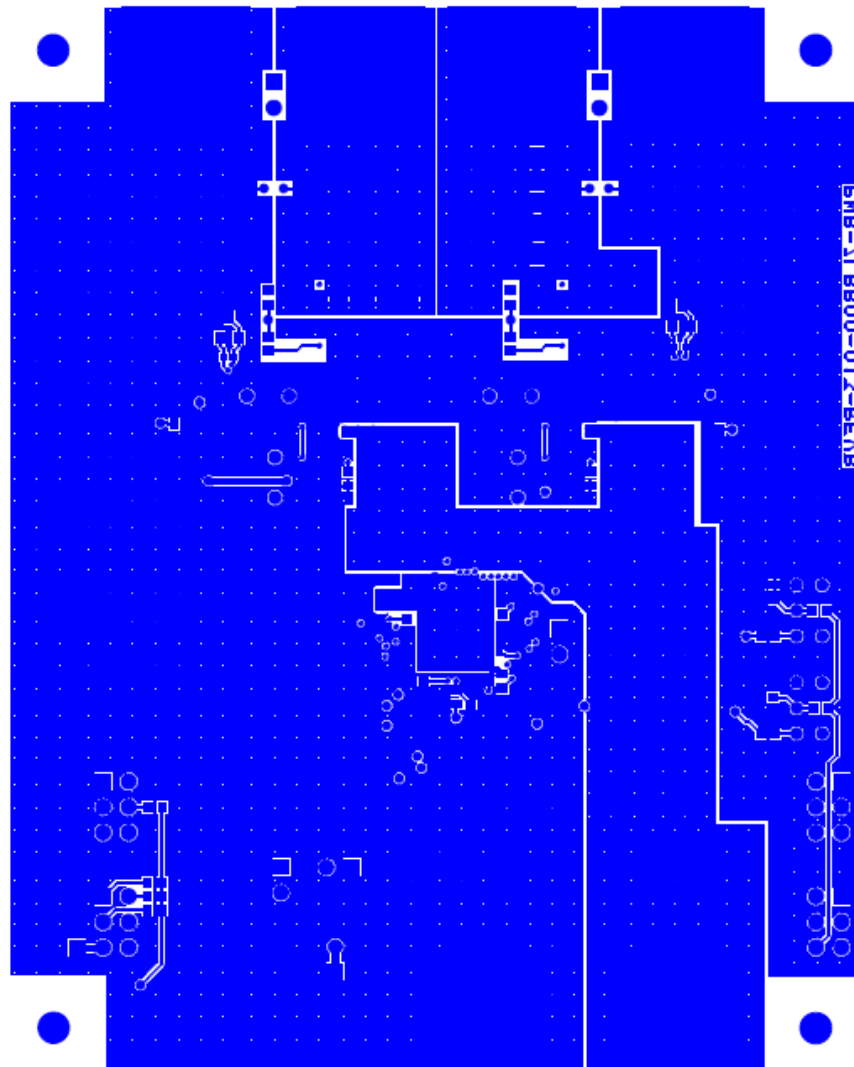

FIGURE 21. PCB - BOTTOM LAYER (TOP VIEW)

# ZL8800-2CH-DEMO1Z Board Layout (Continued)

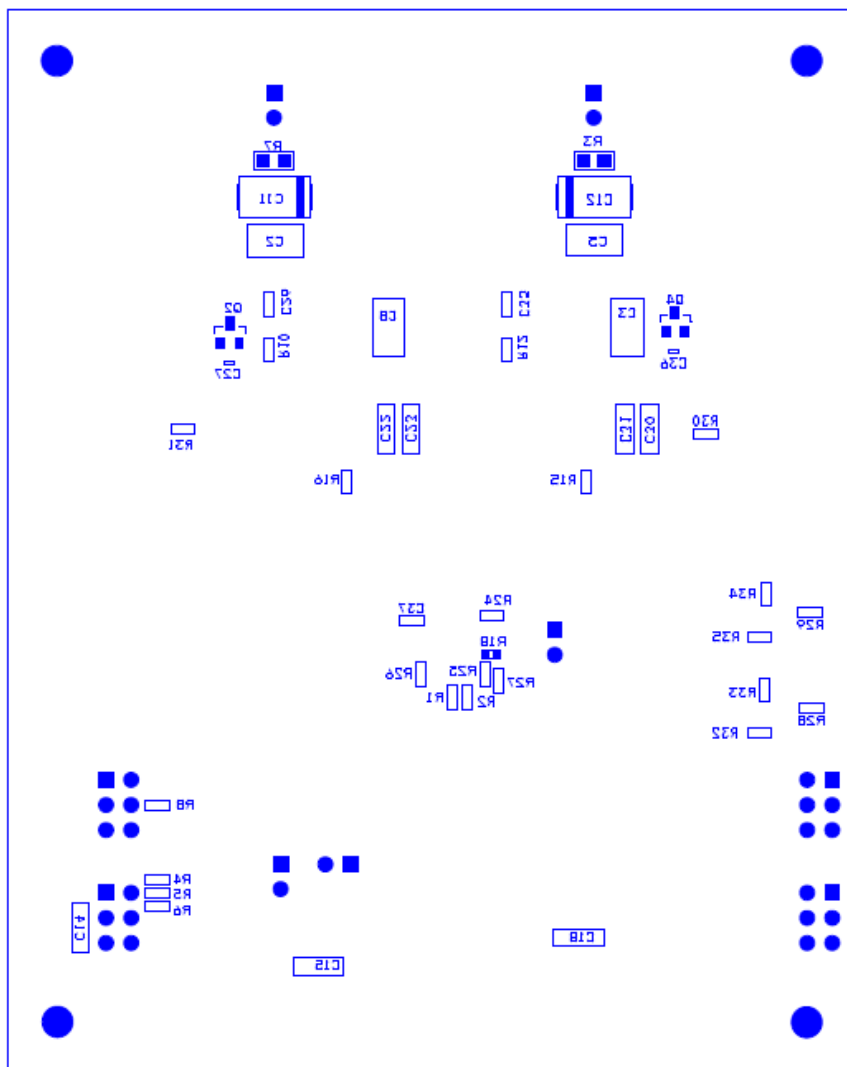

FIGURE 22. PCB - BOTTOM ASSEMBLY (TOP VIEW)



## Notice

1. Descriptions of circuits, software and other related information in this document are provided only to illustrate the operation of semiconductor products and application examples. You are fully responsible for the incorporation or any other use of the circuits, software, and information in the design of your product or system. Renesas Electronics disclaims any and all liability for any losses and damages incurred by you or third parties arising from the use of these circuits, software, or information.
2. Renesas Electronics hereby expressly disclaims any warranties against and liability for infringement or any other claims involving patents, copyrights, or other intellectual property rights of third parties, by or arising from the use of Renesas Electronics products or technical information described in this document, including but not limited to, the product data, drawings, charts, programs, algorithms, and application examples.
3. No license, express, implied or otherwise, is granted hereby under any patents, copyrights or other intellectual property rights of Renesas Electronics or others.
4. You shall not alter, modify, copy, or reverse engineer any Renesas Electronics product, whether in whole or in part. Renesas Electronics disclaims any and all liability for any losses or damages incurred by you or third parties arising from such alteration, modification, copying or reverse engineering.
5. Renesas Electronics products are classified according to the following two quality grades: "Standard" and "High Quality". The intended applications for each Renesas Electronics product depends on the product's quality grade, as indicated below.  
"Standard": Computers; office equipment; communications equipment; test and measurement equipment; audio and visual equipment; home electronic appliances; machine tools; personal electronic equipment; industrial robots; etc.  
"High Quality": Transportation equipment (automobiles, trains, ships, etc.); traffic control (traffic lights); large-scale communication equipment; key financial terminal systems; safety control equipment; etc.  
Unless expressly designated as a high reliability product or a product for harsh environments in a Renesas Electronics data sheet or other Renesas Electronics document, Renesas Electronics products are not intended or authorized for use in products or systems that may pose a direct threat to human life or bodily injury (artificial life support devices or systems; surgical implantations; etc.), or may cause serious property damage (space system; undersea repeaters; nuclear power control systems; aircraft control systems; key plant systems; military equipment; etc.). Renesas Electronics disclaims any and all liability for any damages or losses incurred by you or any third parties arising from the use of any Renesas Electronics product that is inconsistent with any Renesas Electronics data sheet, user's manual or other Renesas Electronics document.
6. When using Renesas Electronics products, refer to the latest product information (data sheets, user's manuals, application notes, "General Notes for Handling and Using Semiconductor Devices" in the reliability handbook, etc.), and ensure that usage conditions are within the ranges specified by Renesas Electronics with respect to maximum ratings, operating power supply voltage range, heat dissipation characteristics, installation, etc. Renesas Electronics disclaims any and all liability for any malfunctions, failure or accident arising out of the use of Renesas Electronics products outside of such specified ranges.
7. Although Renesas Electronics endeavors to improve the quality and reliability of Renesas Electronics products, semiconductor products have specific characteristics, such as the occurrence of failure at a certain rate and malfunctions under certain use conditions. Unless designated as a high reliability product or a product for harsh environments in a Renesas Electronics data sheet or other Renesas Electronics document, Renesas Electronics products are not subject to radiation resistance design. You are responsible for implementing safety measures to guard against the possibility of bodily injury, injury or damage caused by fire, and/or danger to the public in the event of a failure or malfunction of Renesas Electronics products, such as safety design for hardware and software, including but not limited to redundancy, fire control and malfunction prevention, appropriate treatment for aging degradation or any other appropriate measures. Because the evaluation of microcomputer software alone is very difficult and impractical, you are responsible for evaluating the safety of the final products or systems manufactured by you.
8. Please contact a Renesas Electronics sales office for details as to environmental matters such as the environmental compatibility of each Renesas Electronics product. You are responsible for carefully and sufficiently investigating applicable laws and regulations that regulate the inclusion or use of controlled substances, including without limitation, the EU RoHS Directive, and using Renesas Electronics products in compliance with all these applicable laws and regulations. Renesas Electronics disclaims any and all liability for damages or losses occurring as a result of your noncompliance with applicable laws and regulations.
9. Renesas Electronics products and technologies shall not be used for or incorporated into any products or systems whose manufacture, use, or sale is prohibited under any applicable domestic or foreign laws or regulations. You shall comply with any applicable export control laws and regulations promulgated and administered by the governments of any countries asserting jurisdiction over the parties or transactions.
10. It is the responsibility of the buyer or distributor of Renesas Electronics products, or any other party who distributes, disposes of, or otherwise sells or transfers the product to a third party, to notify such third party in advance of the contents and conditions set forth in this document.
11. This document shall not be reprinted, reproduced or duplicated in any form, in whole or in part, without prior written consent of Renesas Electronics.
12. Please contact a Renesas Electronics sales office if you have any questions regarding the information contained in this document or Renesas Electronics products.  
(Note 1) "Renesas Electronics" as used in this document means Renesas Electronics Corporation and also includes its directly or indirectly controlled subsidiaries.  
(Note 2) "Renesas Electronics product(s)" means any product developed or manufactured by or for Renesas Electronics.

(Rev.4.0-1 November 2017)



### SALES OFFICES

Renesas Electronics Corporation

<http://www.renesas.com>

Refer to "<http://www.renesas.com/>" for the latest and detailed information.

**Renesas Electronics America Inc.**  
1001 Murphy Ranch Road, Milpitas, CA 95035, U.S.A.  
Tel: +1-408-432-8888, Fax: +1-408-434-5351

**Renesas Electronics Canada Limited**  
9251 Yonge Street, Suite 8309 Richmond Hill, Ontario Canada L4C 9T3  
Tel: +1-905-237-2004

**Renesas Electronics Europe Limited**  
Dukes Meadow, Millboard Road, Bourne End, Buckinghamshire, SL8 5FH, U.K  
Tel: +44-1628-651-700, Fax: +44-1628-651-804

**Renesas Electronics Europe GmbH**  
Arcadiastrasse 10, 40472 Düsseldorf, Germany  
Tel: +49-211-6503-0, Fax: +49-211-6503-1327

**Renesas Electronics (China) Co., Ltd.**  
Room 1709 Quantum Plaza, No.27 ZhichunLu, Haidian District, Beijing, 100191 P. R. China  
Tel: +86-10-8235-1155, Fax: +86-10-8235-7679

**Renesas Electronics (Shanghai) Co., Ltd.**  
Unit 301, Tower A, Central Towers, 555 Langao Road, Putuo District, Shanghai, 200333 P. R. China  
Tel: +86-21-2226-0888, Fax: +86-21-2226-0999

**Renesas Electronics Hong Kong Limited**  
Unit 1601-1611, 16/F., Tower 2, Grand Century Place, 193 Prince Edward Road West, Mongkok, Kowloon, Hong Kong  
Tel: +852-2265-6688, Fax: +852-2886-9022

**Renesas Electronics Taiwan Co., Ltd.**  
13F, No. 363, Fu Shing North Road, Taipei 10543, Taiwan  
Tel: +886-2-8175-9600, Fax: +886-2-8175-9670

**Renesas Electronics Singapore Pte. Ltd.**  
80 Bendemeer Road, Unit #06-02 Hyflux Innovation Centre, Singapore 339949  
Tel: +65-6213-0200, Fax: +65-6213-0300

**Renesas Electronics Malaysia Sdn.Bhd.**  
Unit 1207, Block B, Menara Amcorp, Amcorp Trade Centre, No. 18, Jln Persiaran Barat, 46050 Petaling Jaya, Selangor Darul Ehsan, Malaysia  
Tel: +60-3-7955-9390, Fax: +60-3-7955-9510

**Renesas Electronics India Pvt. Ltd.**  
No.777C, 100 Feet Road, HAL 2nd Stage, Indiranagar, Bangalore 560 038, India  
Tel: +91-80-67208700, Fax: +91-80-67208777

**Renesas Electronics Korea Co., Ltd.**  
17F, KAMCO Yangjae Tower, 262, Gangnam-daero, Gangnam-gu, Seoul, 06265 Korea  
Tel: +82-2-558-3737, Fax: +82-2-558-5338