

INDUCTIVE POSITION SENSOR (IPS) DESIGN GUIDELINES

2021-03-08

RENESAS ELECTRONICS CORPORATION

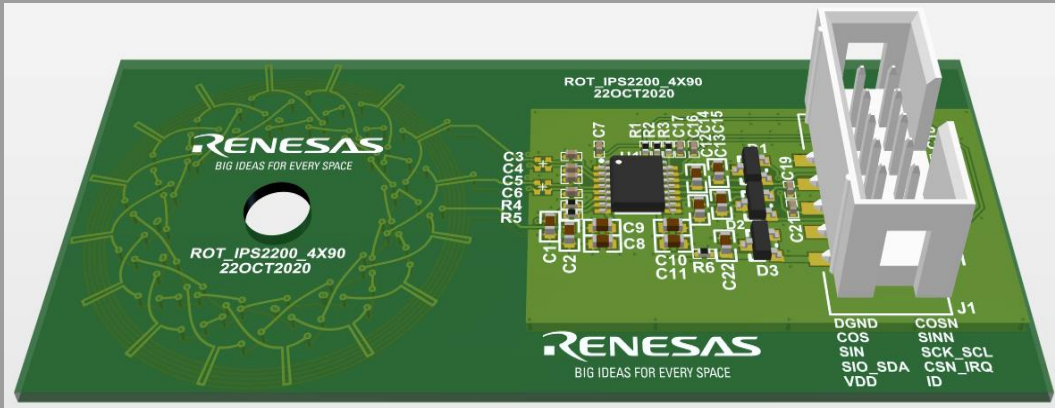

CONTENTS

- Introduction
 - What is an IPS design?
 - Tools for design generation
- Working with custom generated coils (ICOT)
 - How to import and adjust Gerber data?
 - How to export Gerber to PCB?
 - Design hints - Altium Designer
- Working with templates
 - How to obtain the templates?
 - How to connect the sensor coils?
 - Basic EMC recommendations
 - PCB Target design

WHAT IS AN IPS DESIGN?

PCB = Printed Circuit Board

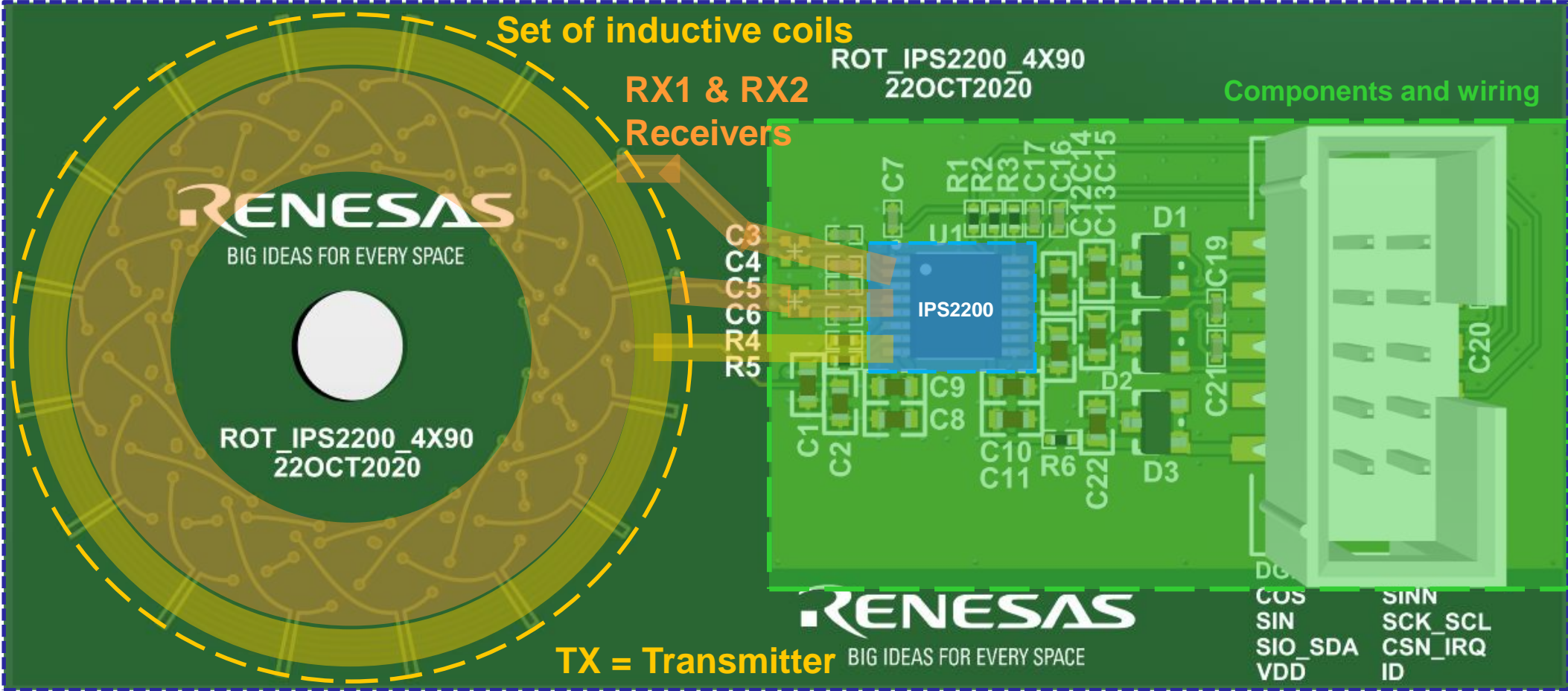

TOOLS FOR DESIGN GENERATION

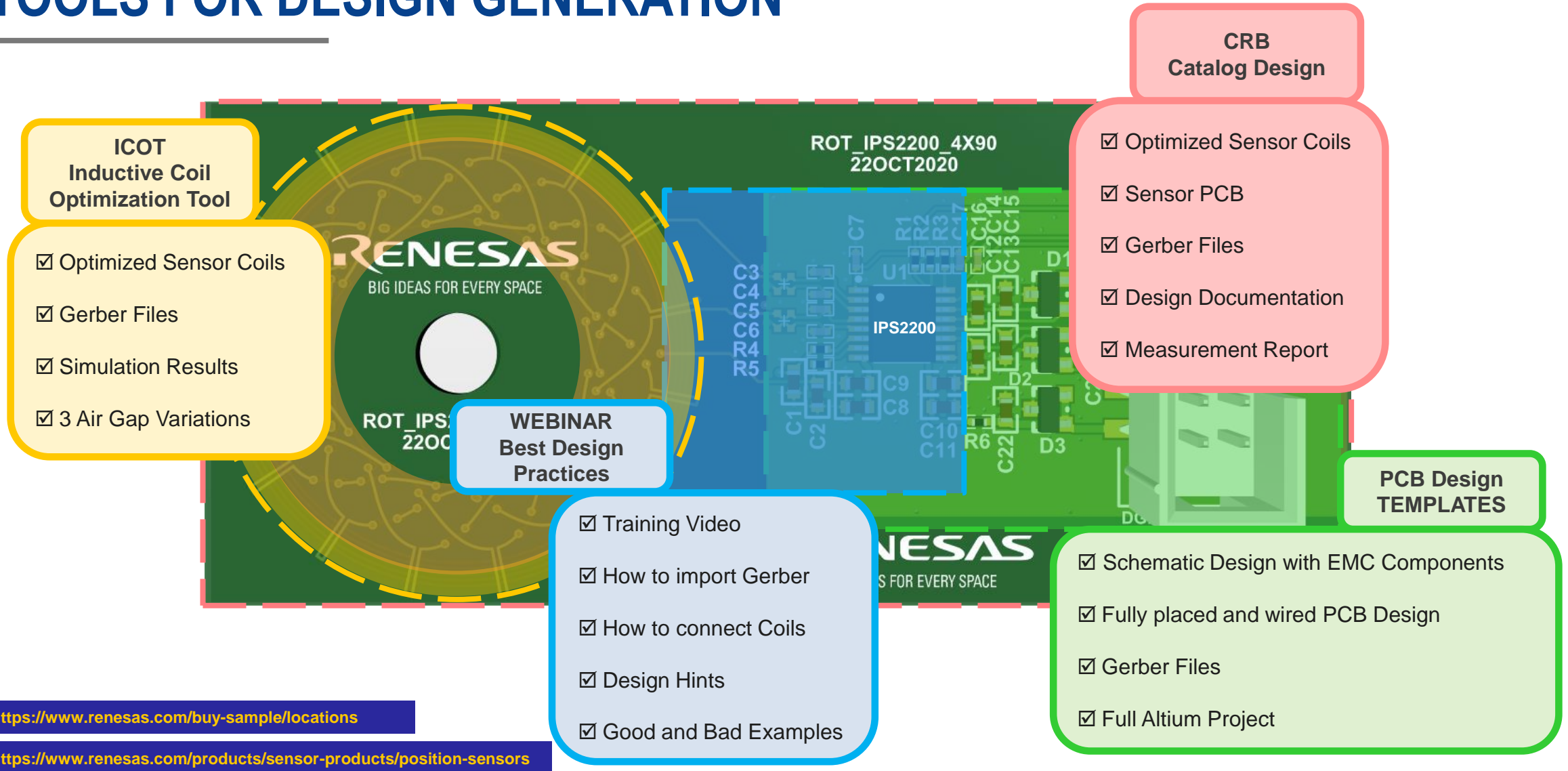

HOW TO IMPORT GERBER?

☑ Gerber Files of Optimized Sensor Coils

pcb_layout_advanced.zip
227 KB

Save and unpack ZIP container

1

Dear User,
Your coil design optimization results are attached in the email.
Please send an email to „Teamsupport@coildesign“ if any questions.

Send the legal disclaimer as a PDF to the customer upfront.
The Legal Disclaimer can be found on Seismic as “Renesas Inductive Position Sensor”
Do not deliver the results and the Gerber files without the customer acknowledgment.
Attach the disclaimer again when the results and the Gerber files are sent.

Note
The attached ZIP file is encrypted with your user password.

Regards,
AASBD Apps support team

NB: This is a generated email please do not reply.

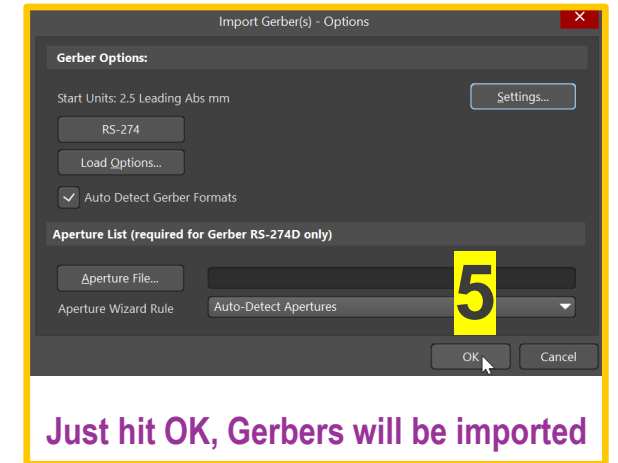
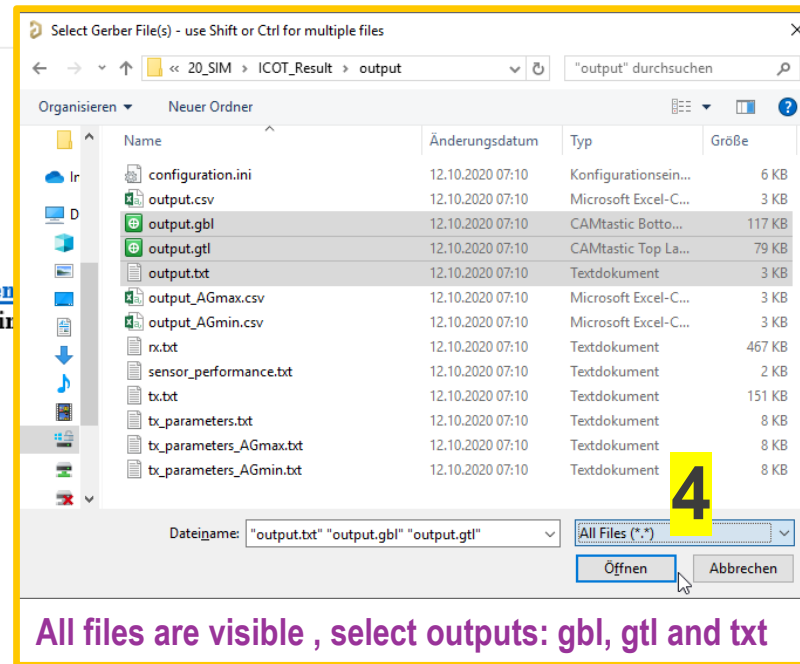
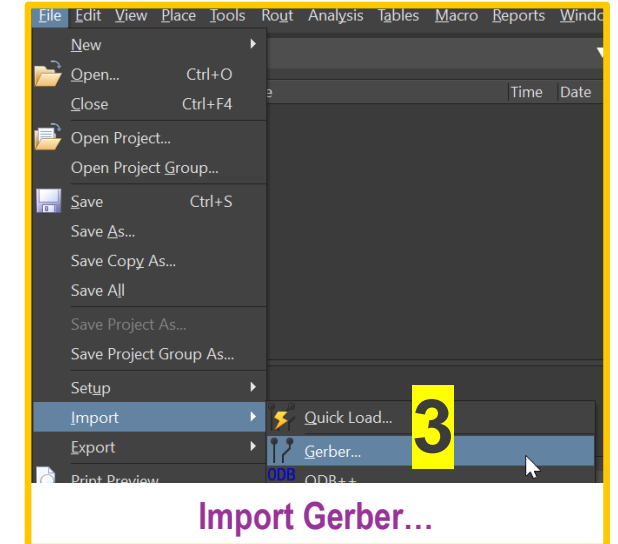
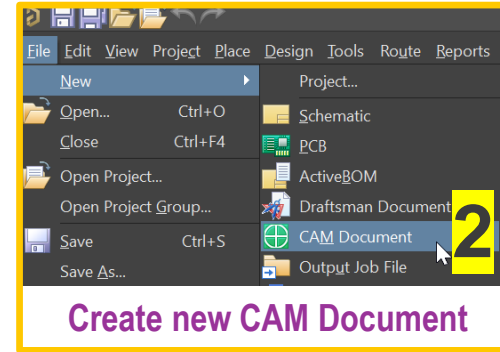

HOW TO SET THE LAYERS?

Home Page CAMtastic.Cam * LogFileLog_2020_10_14_16_33.log

```

CAMtastic DXF : Gerber / NC Drill / Mill/Rout Import Process Report
CAMtastic File : CAMtastic.Cam
Date : 14/10/2020
Time : 4:33:33 PM

Information : Layer 1 - output.gbl - start loading.
Information : Layer 1 - output.gbl - end loading.
Information : Layer 2 - output.gtl - start loading.
Information : Layer 2 - output.gtl - end loading.
Information : Layer 3 - output.txt - start loading.
Information : Layer 3 - output.txt - end loading.

Statistics :
Errors : 0
Warnings : 0
Information : 6
    
```

1

0 Errors and 0 Warnings → good

2

Back to CAMtastic, coils imported

Tables Macro Reports Window

- Aperture List Wizard...
- Apertures... Shift+A
- Layers...**
- Layer Type Detection

3

Click Tables, Layers...

#	Layer Name	Type	Draw	Flash	On	Lock	Delete
1	output.gbl	Bottom	<input checked="" type="checkbox"/>	<input checked="" type="checkbox"/>	<input checked="" type="checkbox"/>	<input type="checkbox"/>	<input type="checkbox"/>
2	output.gtl	Top	<input checked="" type="checkbox"/>	<input checked="" type="checkbox"/>	<input checked="" type="checkbox"/>	<input type="checkbox"/>	<input type="checkbox"/>
3	output.txt	Border	<input checked="" type="checkbox"/>	<input checked="" type="checkbox"/>	<input checked="" type="checkbox"/>	<input type="checkbox"/>	<input type="checkbox"/>

Top
Bottom
Internal
Neg Plane
Pos Plane
Drill Top
Drill Bot

4

Set the TXT file for drilling layer

#	LayerName	Layer Logical Order	Layer Physical O...
2	L2: gtl	2	1
1	L1: gbl	1	2

5

Set physical Layers: GTL→1, GBL →2

HOW TO SET THE VIAS?

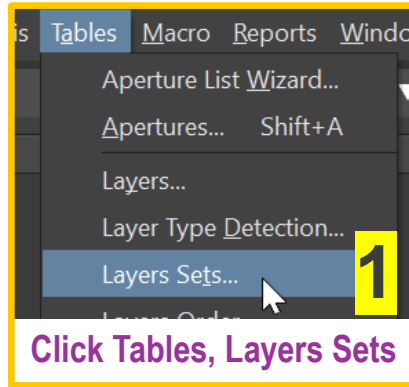

is Tables Macro Reports Window

- Aperture List Wizard...
- Apertures... Shift+A
- Layers...
- Layer Type Detection...
- Layers Sets...** 1
- Layers Order...

Click Tables, Layers Sets

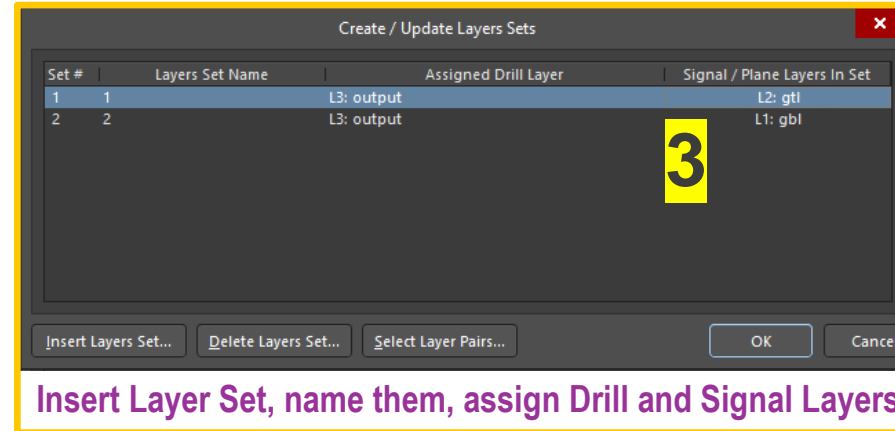

Create / Update Layers Sets

Set #	Layers Set Name	Assigned Drill Layer	Signal / Plane Layers In Set
1	1	L3: output	L2: gtl
2	2	L3: output	L1: gbl

3

Insert Layers Set... Delete Layers Set... Select Layer Pairs... OK Cancel

Insert Layer Set, name them, assign Drill and Signal Layers

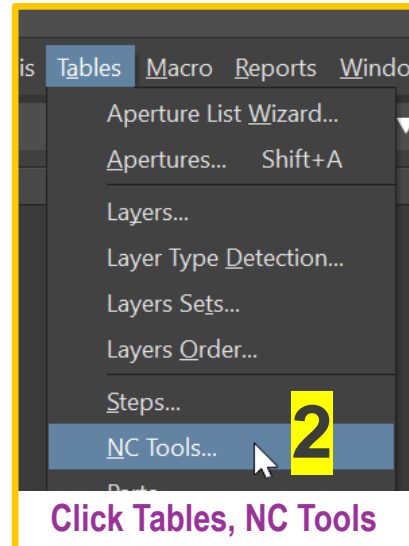

is Tables Macro Reports Window

- Aperture List Wizard...
- Apertures... Shift+A
- Layers...
- Layer Type Detection...
- Layers Sets...
- Layers Order...
- Steps...
- NC Tools...** 2
- Drill...

Click Tables, NC Tools

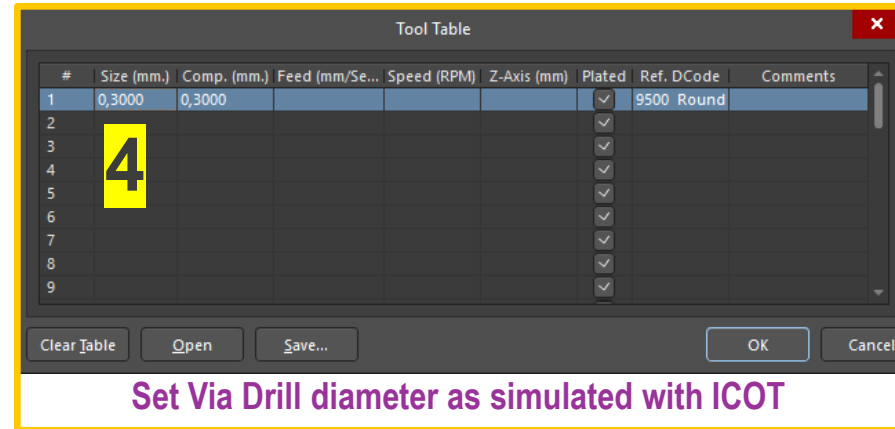

Tool Table

#	Size (mm.)	Comp. (mm.)	Feed (mm/Se...	Speed (RPM)	Z-Axis (mm)	Plated	Ref. DCode	Comments
1	0,3000	0,3000				<input checked="" type="checkbox"/>	9500 Round	
2						<input type="checkbox"/>		
3						<input type="checkbox"/>		
4						<input type="checkbox"/>		
5						<input type="checkbox"/>		
6						<input type="checkbox"/>		
7						<input type="checkbox"/>		
8						<input type="checkbox"/>		
9						<input type="checkbox"/>		

4

Clear Table Open Save... OK Cancel

Set Via Drill diameter as simulated with ICOT

HOW TO EXPORT TO PCB?

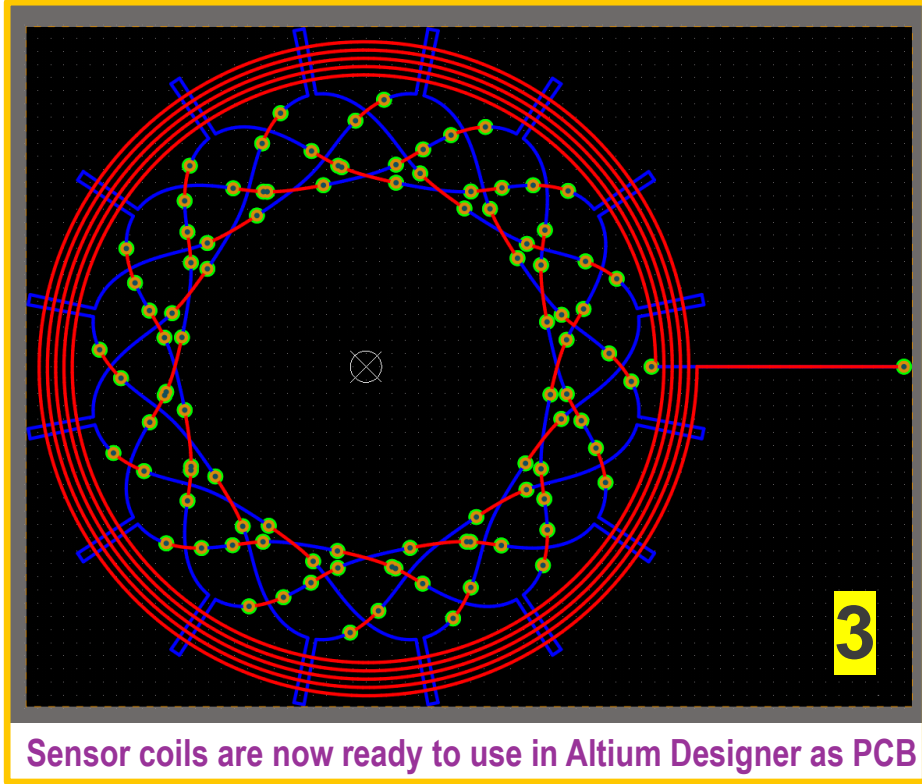
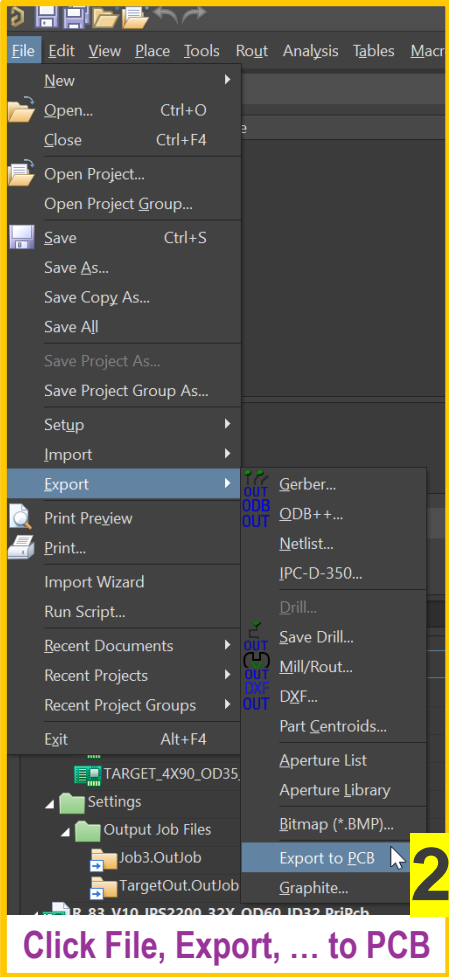
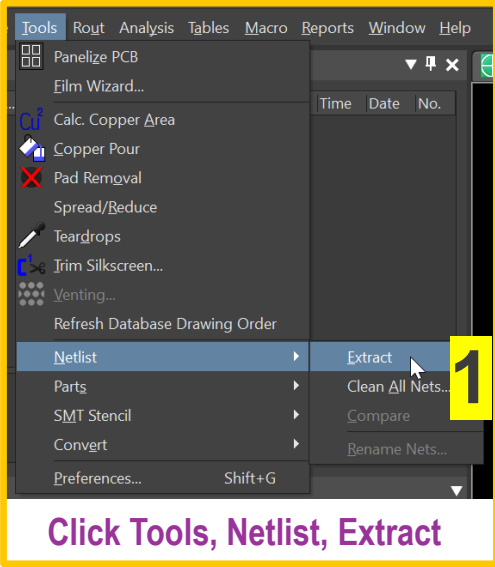

DESIGN HINT FOR ADJUSTING VIAS

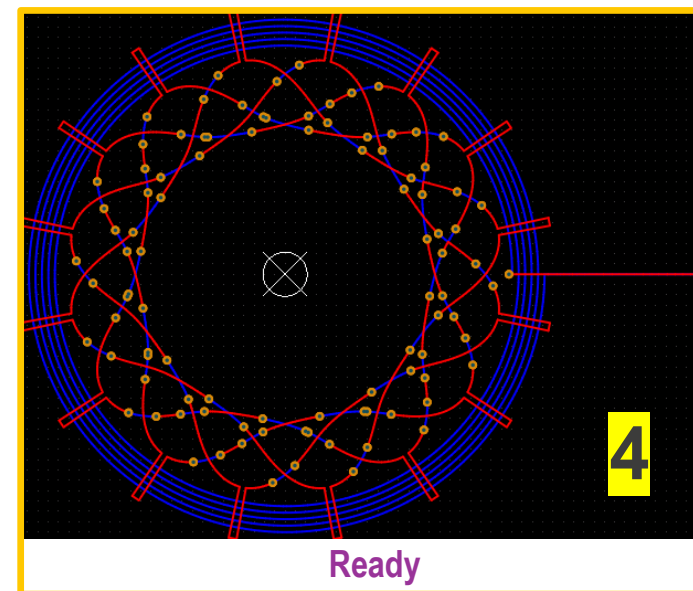
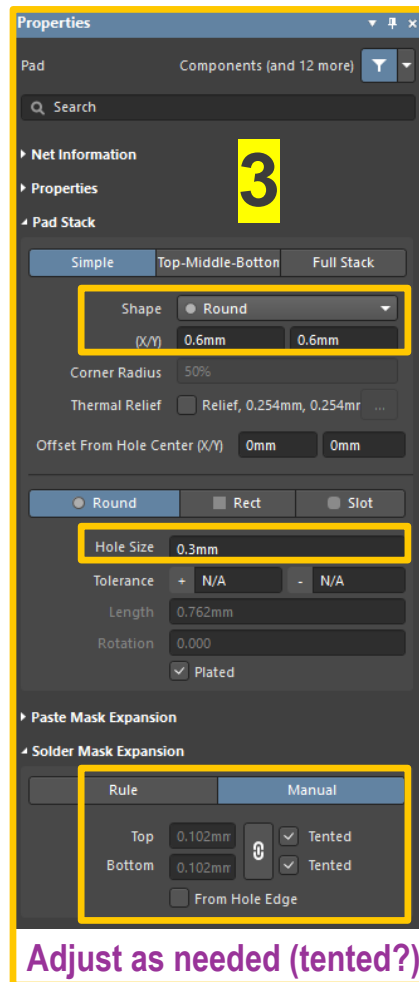
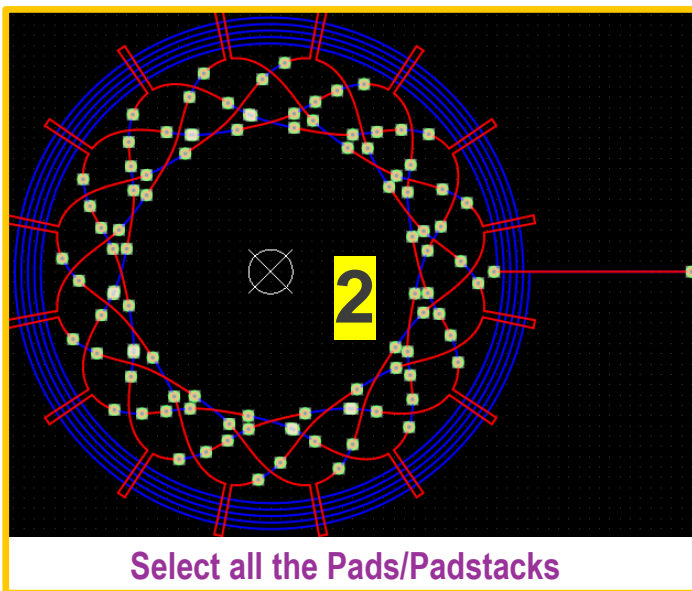



DESIGN HINT FOR SHIFTING LAYERS

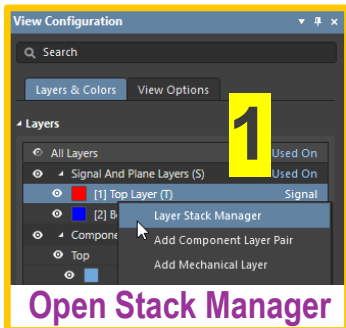

Open Stack Manager

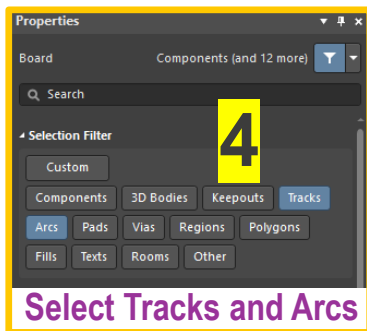

Select Tracks and Arcs

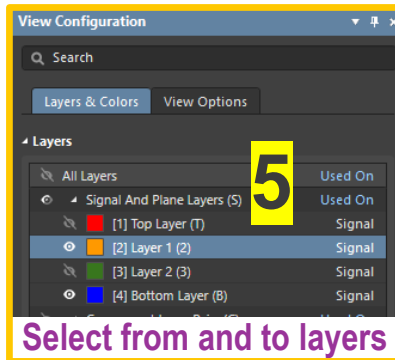

Select from and to layers

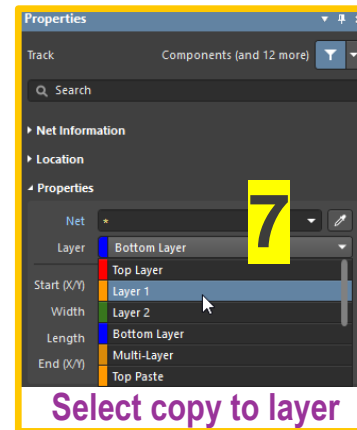

Select copy to layer

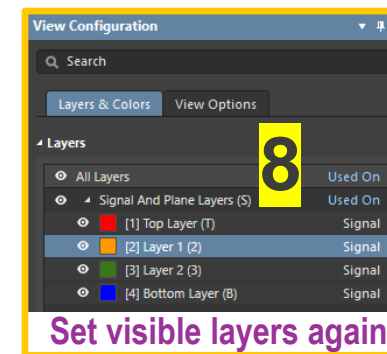

Set visible layers again

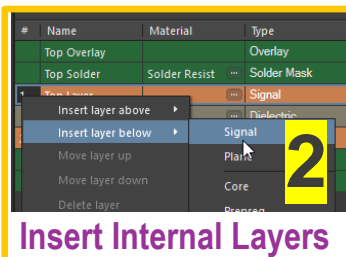

Insert Internal Layers

#	Name	Material	Type	Weight	Thickness
	Top Overlay		Overlay		
	Top Solder	Solder Resist	Solder Mask		0.01016mm
1	Top Layer		Signal	1oz	0.03556mm
	Dielectric 2	PP-006	Prepreg		0.11mm
2	Layer 1	CF-004	Signal	1oz	0.035mm
	Dielectric 1	FR-4	Dielectric		1.11mm
3	Layer 2	CF-004	Signal	1oz	0.035mm
	Dielectric 3	PP-006	Prepreg		0.11mm
4	Bottom Layer		Signal	1oz	0.03556mm
	Bottom Solder	Solder Resist	Solder Mask		0.01016mm
	Bottom Overlay		Overlay		

4 Layers are ready, Save and Exit Stack

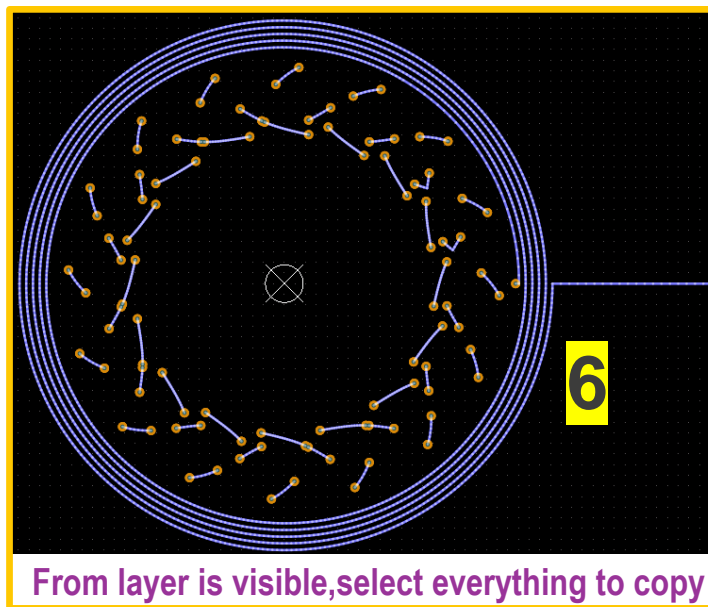

From layer is visible,select everything to copy

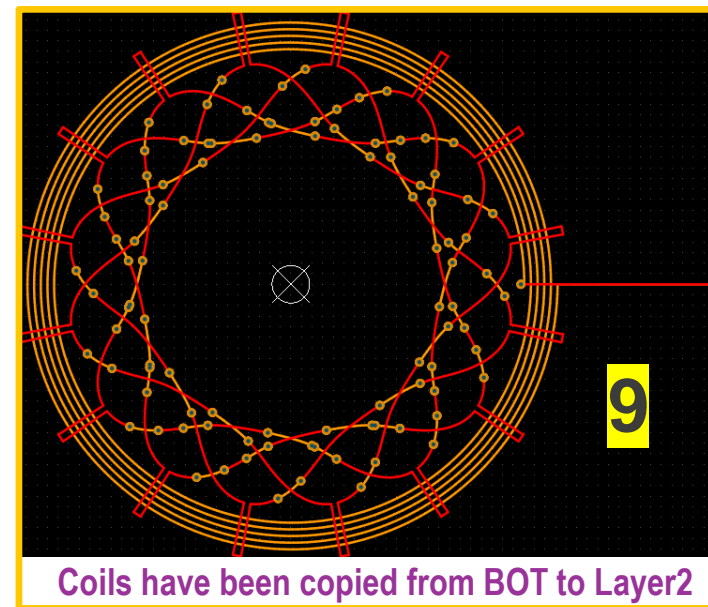

Coils have been copied from BOT to Layer2

HOW TO OPEN THE TEMPLATE?

Download Templates – Altium Project Files

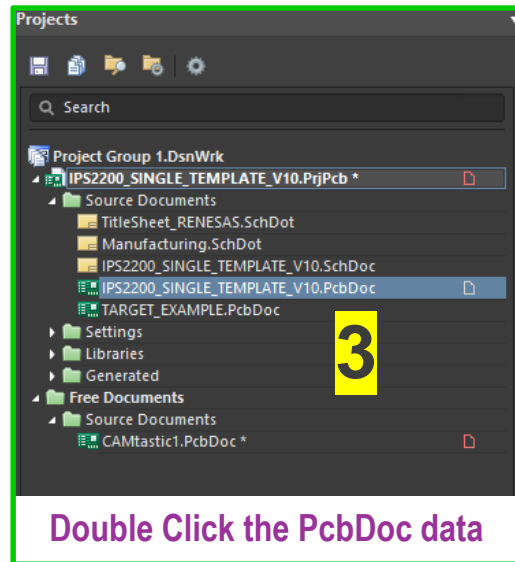
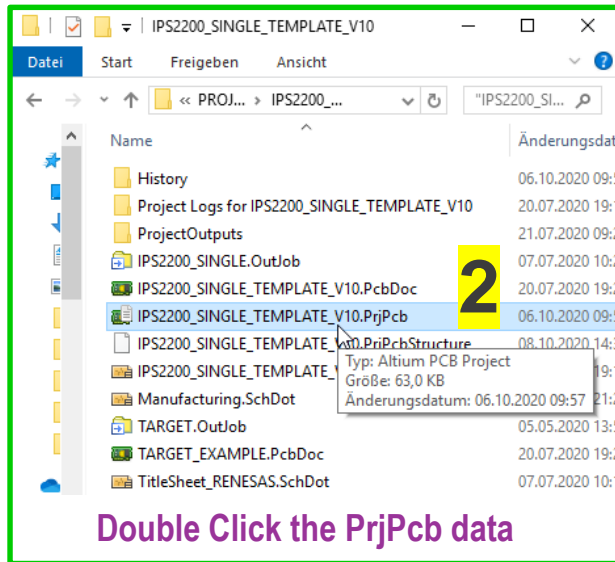

HOW TO COPY/PASTE THE COILS?



Back to the imported coils



Filters all ON

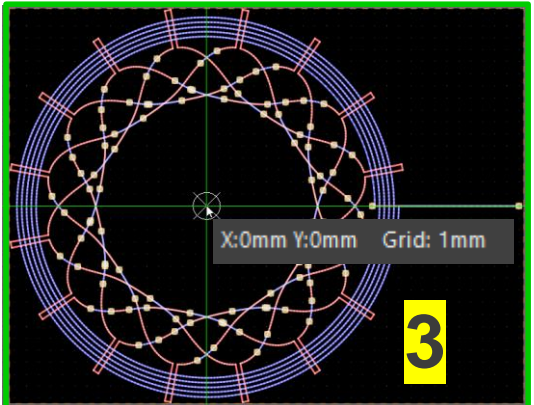

Select everything, press ctrl+c and click on the origin (0;0)

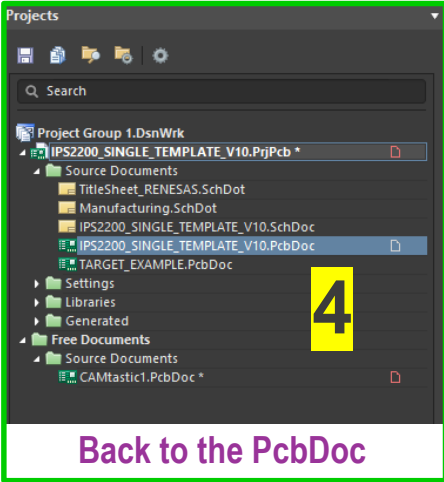

Back to the PcbDoc

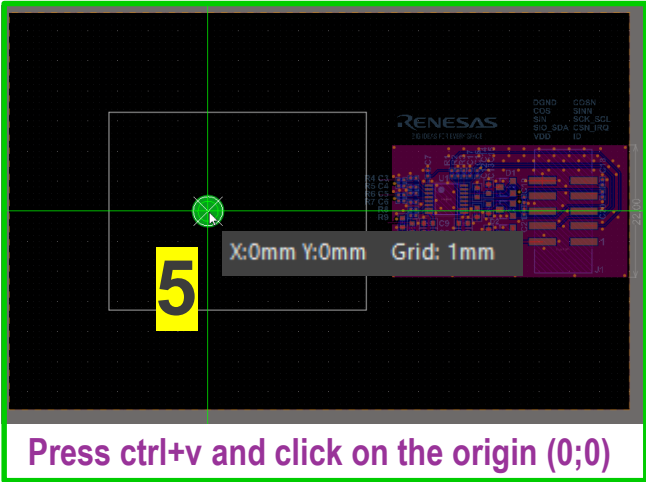

Press ctrl+v and click on the origin (0;0)

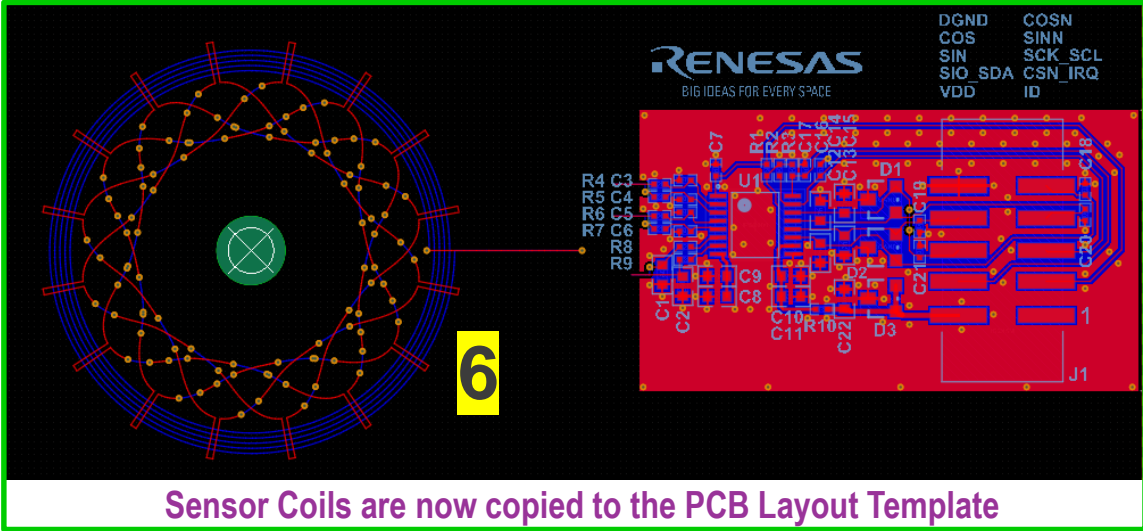

Sensor Coils are now copied to the PCB Layout Template



DESIGN HINT FOR COMPACTING THE BOARD

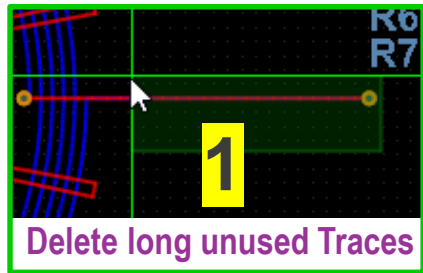

To eliminate the unwanted influence of large metallic objects:

- Keep **3mm** minimum distance from copper planes to the coils!
- Keep **5mm** or larger safety distance if your design lets you!

3

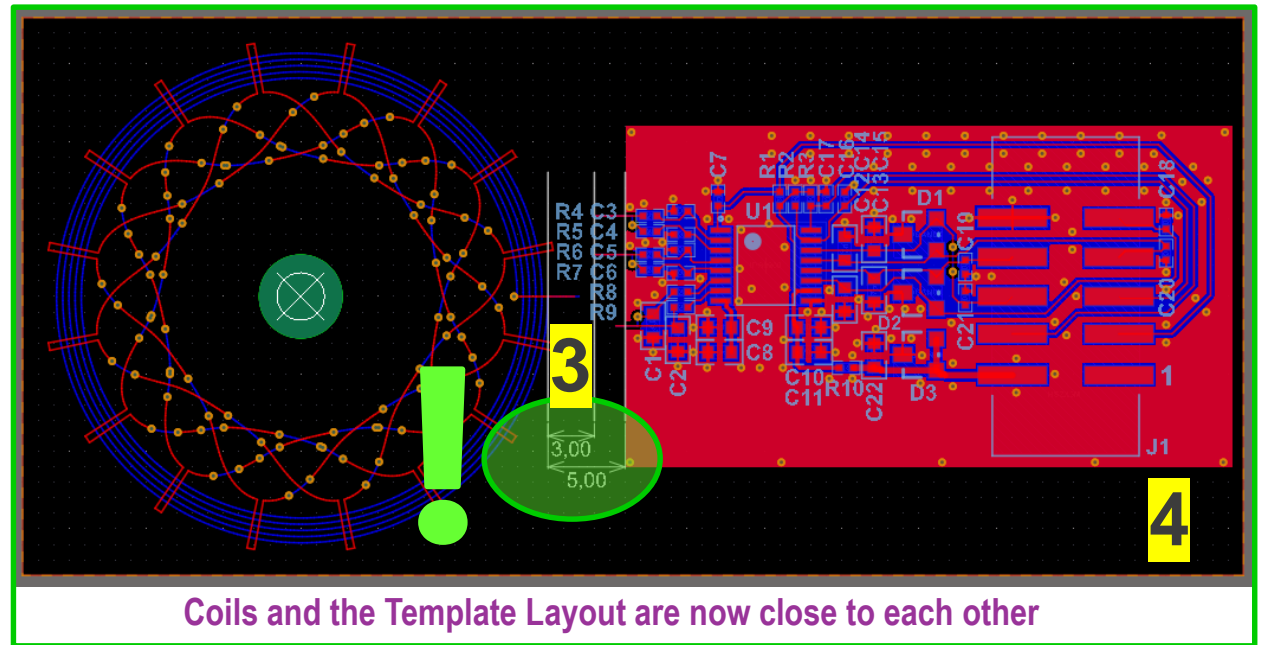
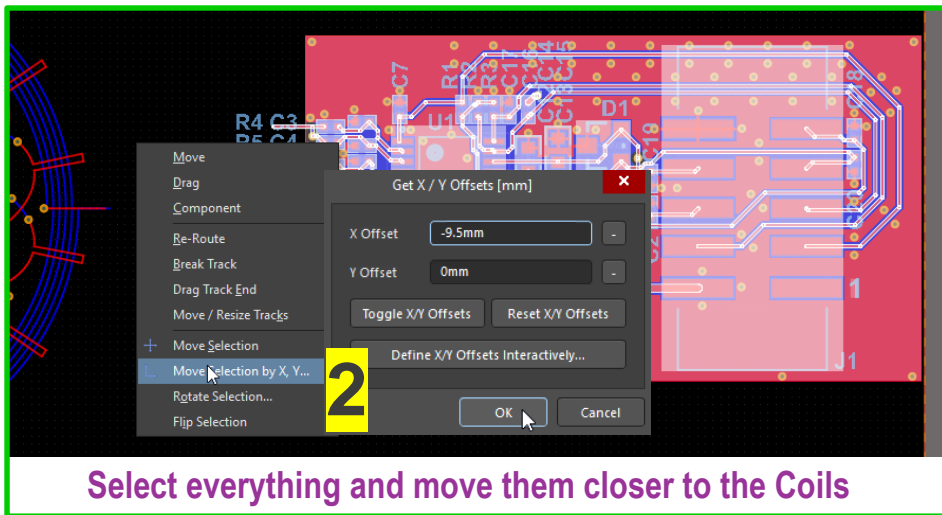

HOW TO RENAME THE COILS?

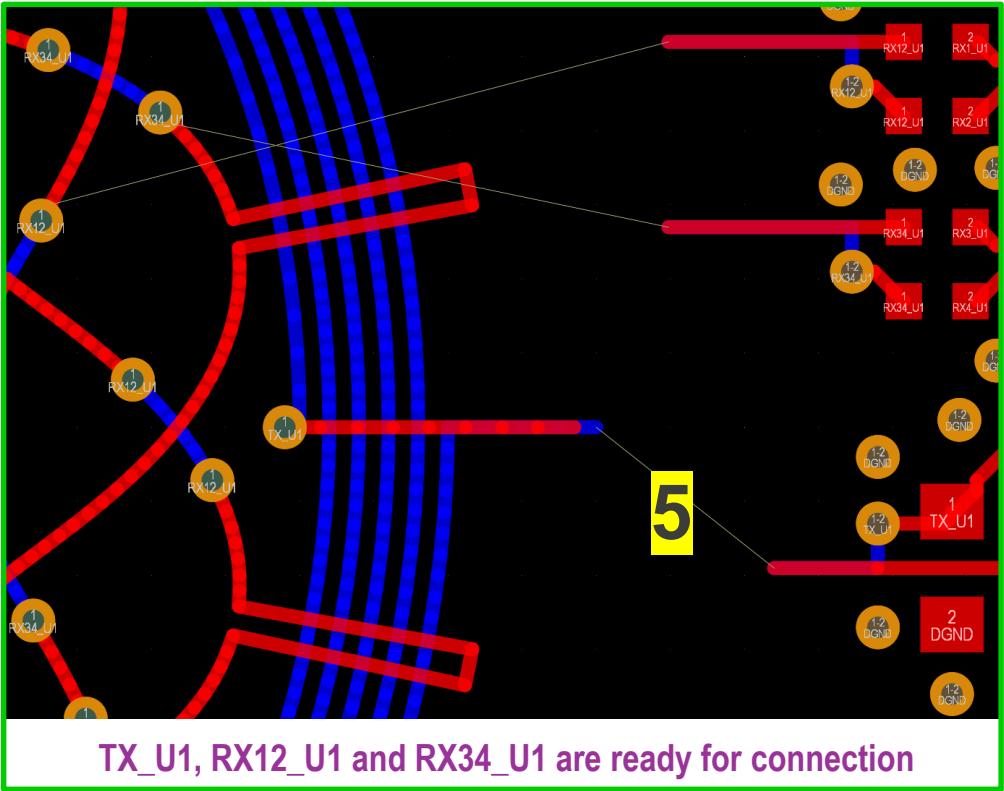
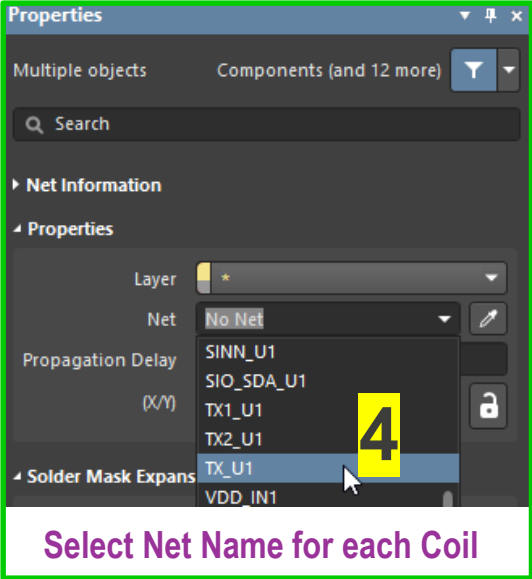
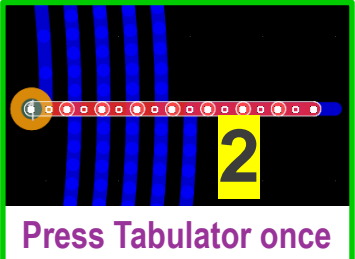
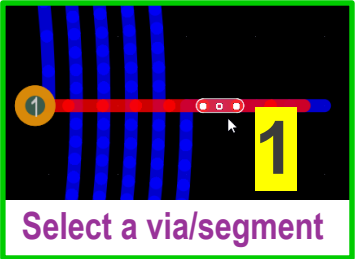

HOW TO CONNECT THE COILS?

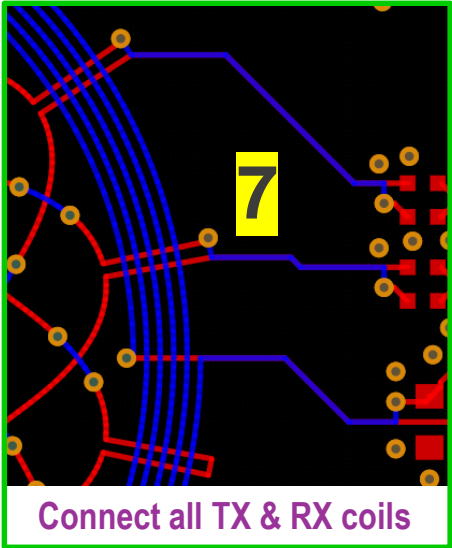
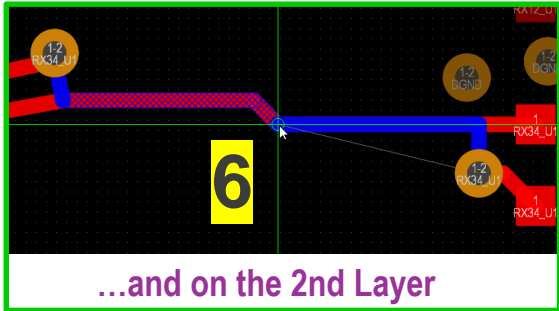
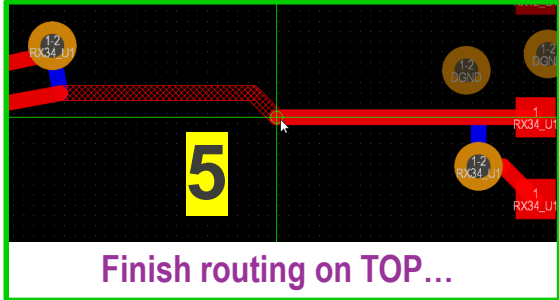
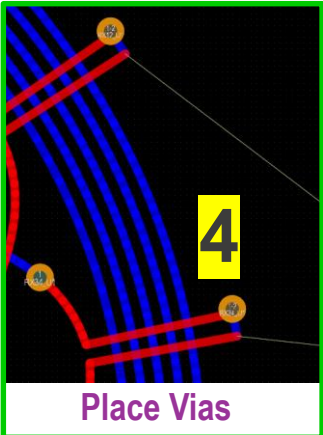
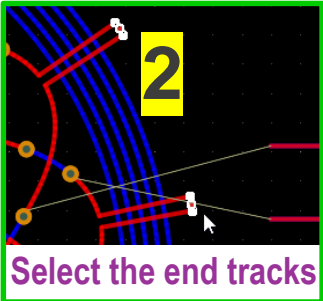
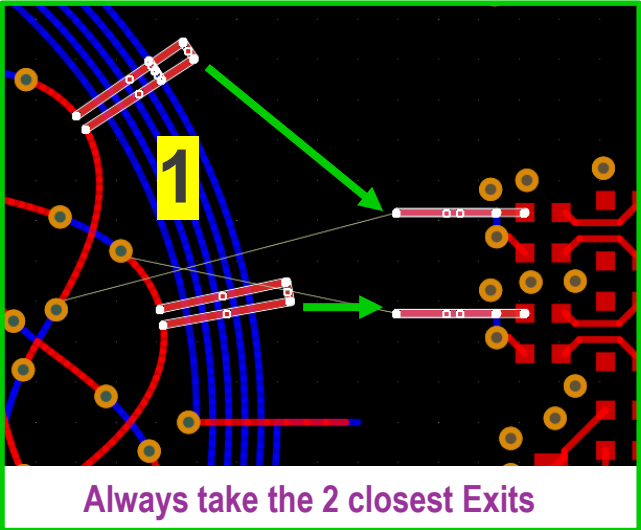



DESIGN HINT FOR COIL ROUTING

To eliminate the unwanted influence of bad wiring:

- 1** Always use the Exits as simulated
- 2** Always route the Coils overlapped on neighboring Layers!
 Don't change the Renesas Layout Template

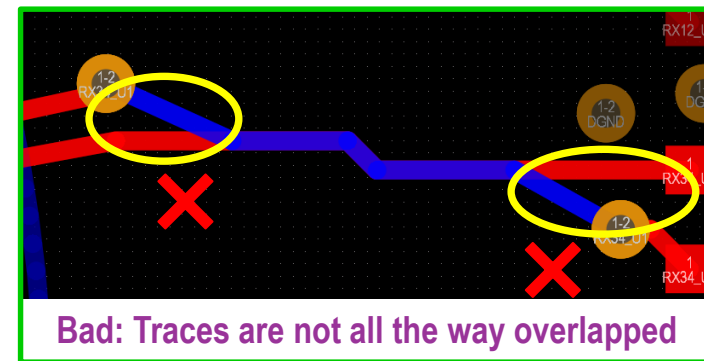
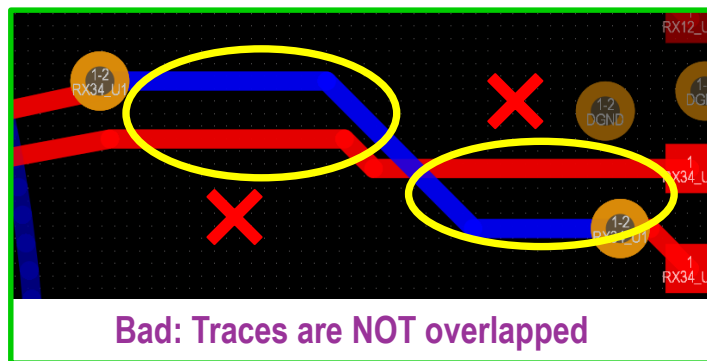
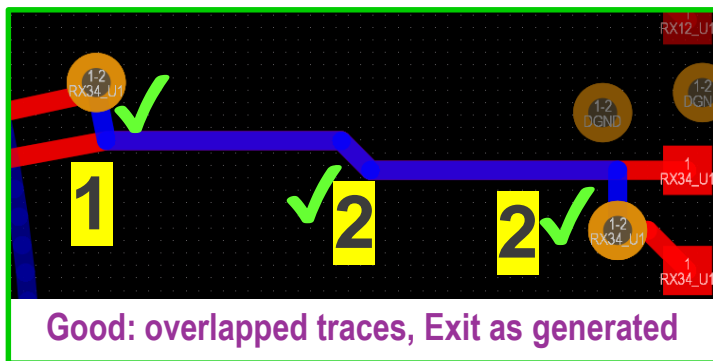



DESIGN HINT FOR GND PLANES

- 1** Always fill all the Copper Layers with GND Planes
- 2** Have at least one fully filled GND Layer below IPS2200
- 3** Use GND Vias to connect the Layers on every 1-2mm
- 4** Consider return Current Paths especially for VDD Supply
- 5** Only very short Tracks are allowed on GND Layer

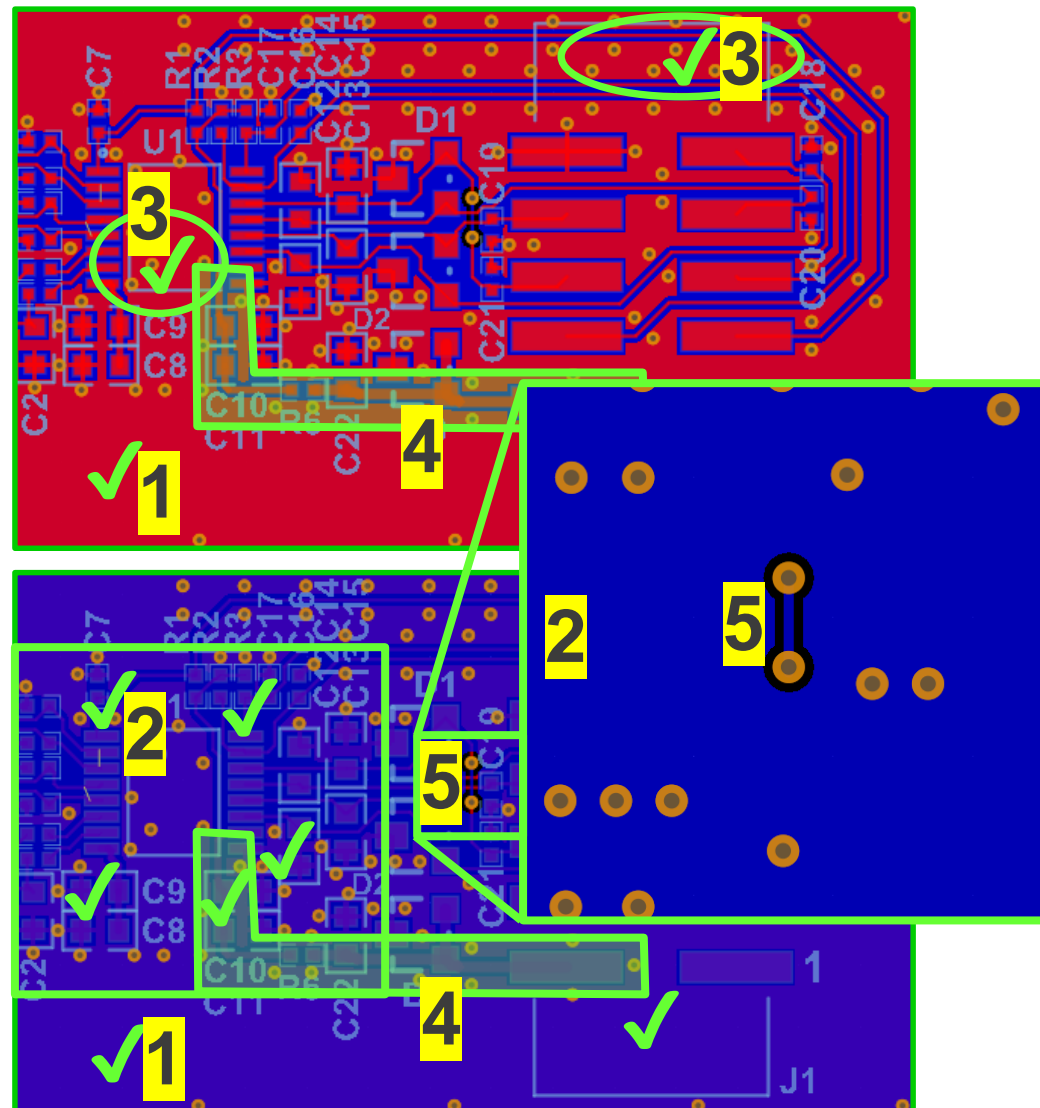

HOW TO DESIGN A PCB TARGET?

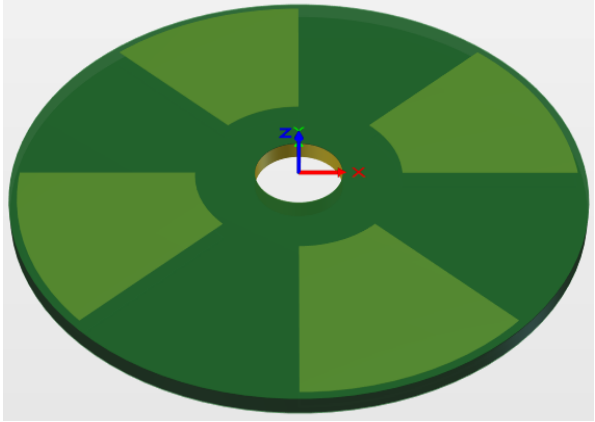

1

Open Target PcbDoc

2

Delete unwanted drawings

3

Design d1mm larger PCB Outline

4

Draw one wing as large as simulated

5

Generate solid Copper Plane

6

Copy/Paste Circular Array

IPS2200 SCHEMATIC TEMPLATES

1 Remove Components if unused or change them freely to your needs!

2 We advise NOT to change the rest of the schematic!

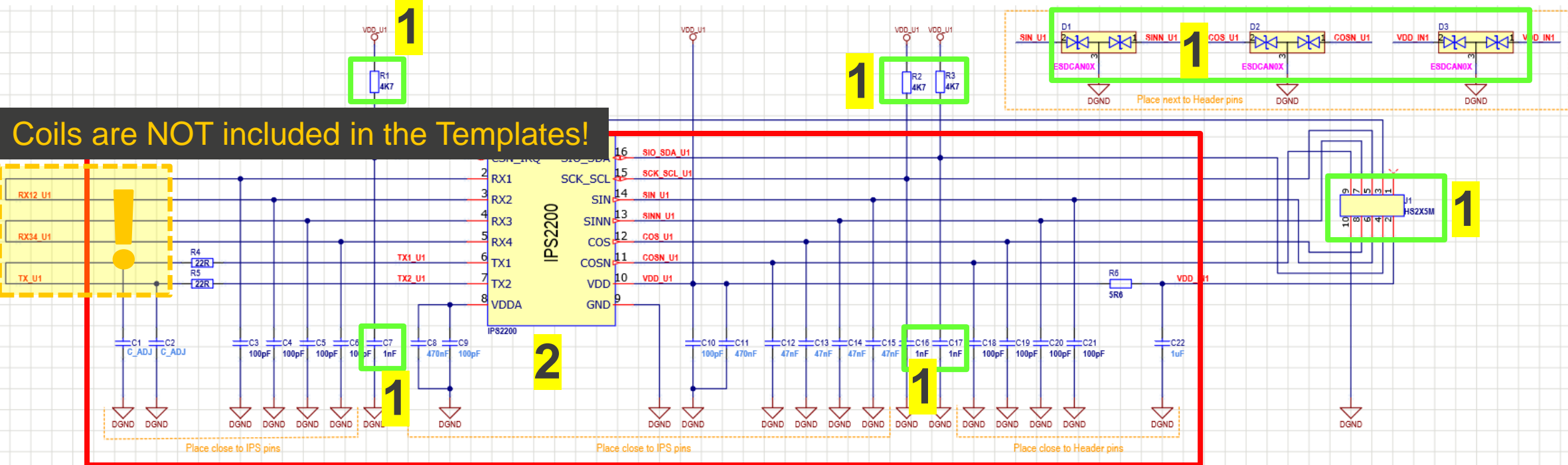

THANK YOU FOR YOUR ATTENTION!