

Understanding Noise in the Signal Chain

Introduction: What is the Signal Chain?

A signal chain is any a series of signal-conditioning components that receive an input, passes the signal from component to component, and produces an output.

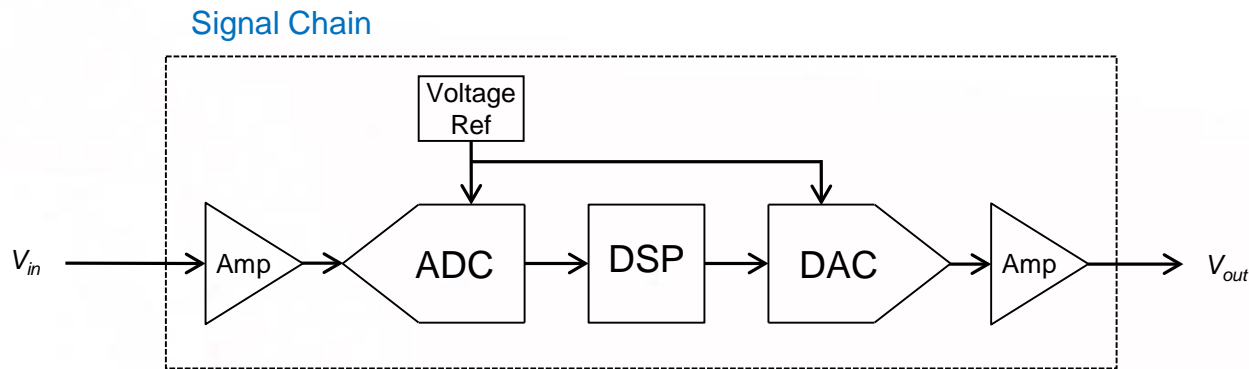

Introduction: What is Noise?

- **Noise is any electrical phenomenon that is unwelcomed in the signal chain**

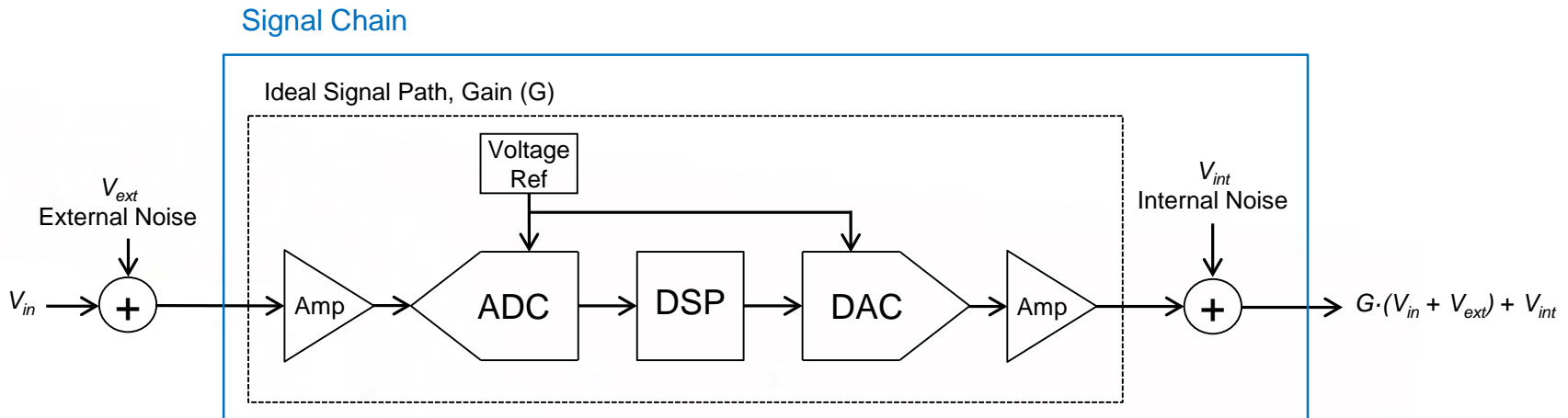

- **Our focus is on the internal sources of noise**
 - Noise in semiconductor devices in general
 - Noise in data converters in particular

Noise in Semiconductor Devices

1. How noise is specified

- a. Noise amplitude
- b. Noise spectral density

2. Types of noise

- a. White noise sources
- b. Pink noise sources

3. Reading noise specifications

- a. Time domain specs
- b. Frequency domain specs

4. Estimating noise amplitudes

- a. Creating a noise spectral density plot
- b. Finding the noise amplitude

Noise in Semiconductor Devices

1. How noise is specified

- a. Noise amplitude
- b. Noise spectral density

2. Types of noise

- a. White noise sources
- b. Pink noise sources

3. Reading noise specifications

- a. Time domain specs
- b. Frequency domain specs

4. Estimating noise amplitudes

- a. Creating a noise spectral density plot
- b. Finding the noise amplitude

Noise in Semiconductor Devices

How Noise is Specified: Amplitude

Noise Amplitude

Semiconductor noise results from random processes and thus the instantaneous amplitude is unpredictable. Amplitude exhibits a Gaussian (Normal) distribution.

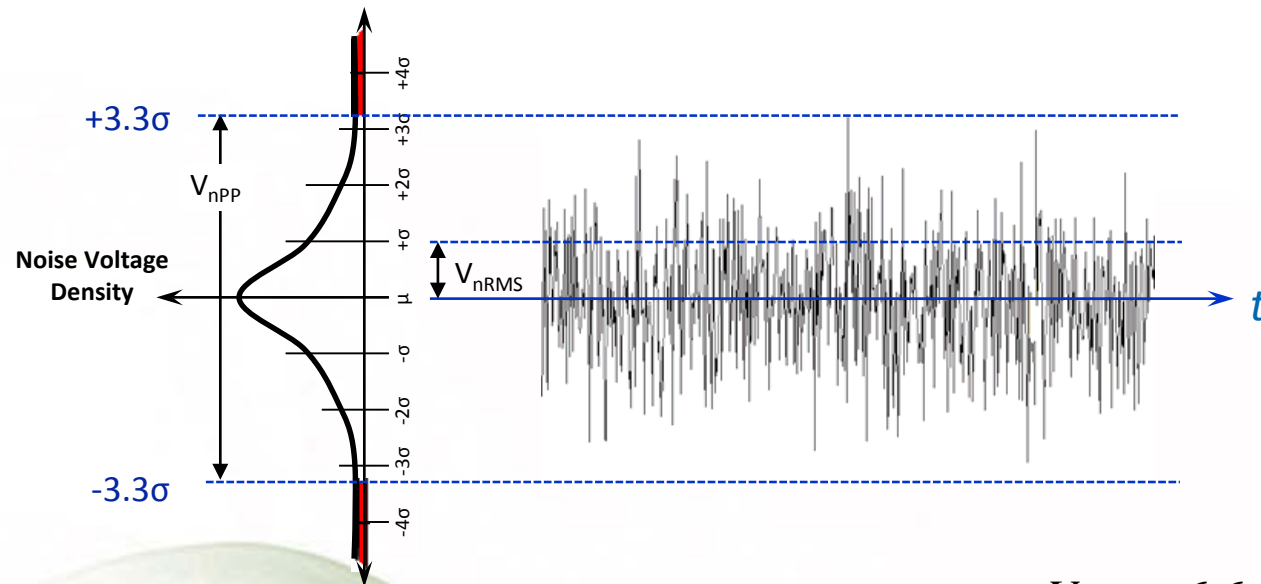

The ratio of $\frac{V_{pp}}{V_{rms}}$ is called the Cresting Factor

$$Vn_{pp} = 6.6 \cdot Vn_{rms}$$

Root Mean Square (RMS)

Peak-to-Peak (PP)

Noise in Semiconductor Devices

How Noise is Specified: Amplitude

Common Cresting Factors

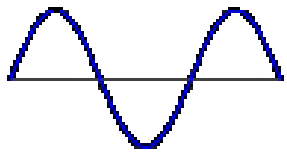

$$\frac{V_P}{V_{RMS}} = \sqrt{2}$$

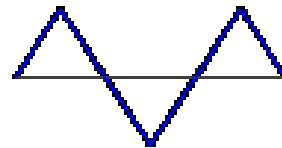

$$\frac{V_P}{V_{RMS}} = \sqrt{3}$$



$$\frac{V_P}{V_{RMS}} = \sqrt{2}$$

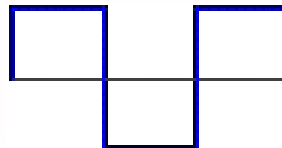

$$\frac{V_P}{V_{RMS}} = 1$$



$$\frac{V_P}{V_{RMS}} = 2$$



$$\frac{V_{PP}}{V_{RMS}} = 6.6$$

Noise in Semiconductor Devices

How Noise is Specified: Spectral Density

Noise Spectral Density

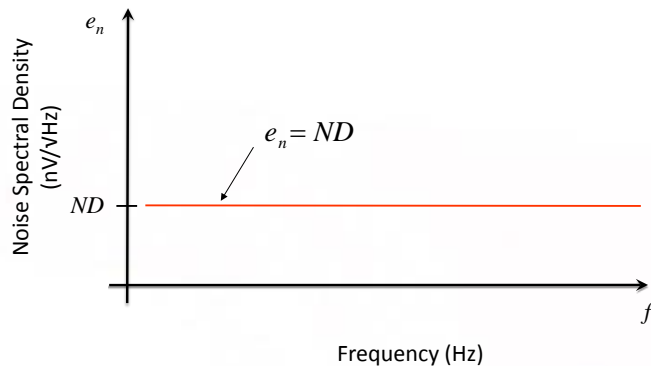

White Noise

Characterized by a uniform spectral density having equal energy in any given bandwidth interval.

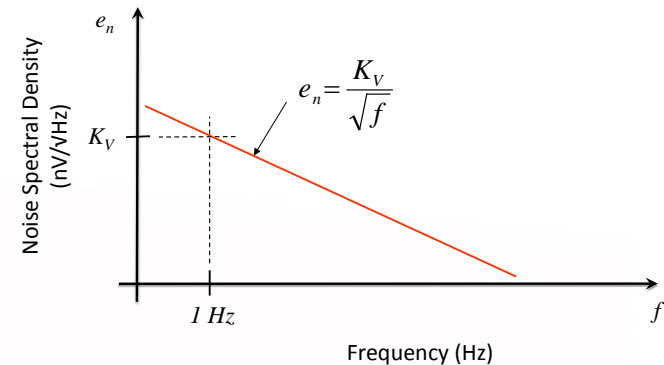

Pink Noise

Characterized by a spectral density that increases inversely proportional to frequency, thus the common name “ $1/f$ ” noise.

Noise in Semiconductor Devices

How Noise is Specified: Spectral Density

Semiconductor noise is a combination of white and pink noise, resulting in the noise spectral density curve shown below, plotted on a log-log scale.

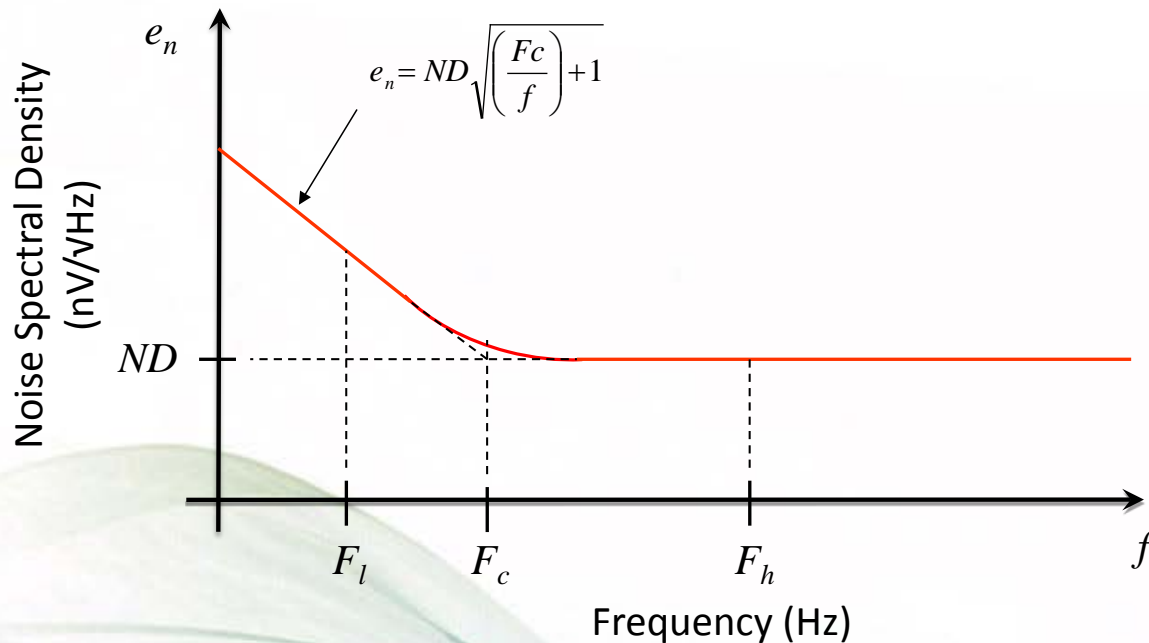

Noise in Semiconductor Devices

How Noise is Specified: Spectral Density

Semiconductor noise is a combination of white and pink noise, resulting in the noise spectral density curve shown below, plotted on a log-log scale.

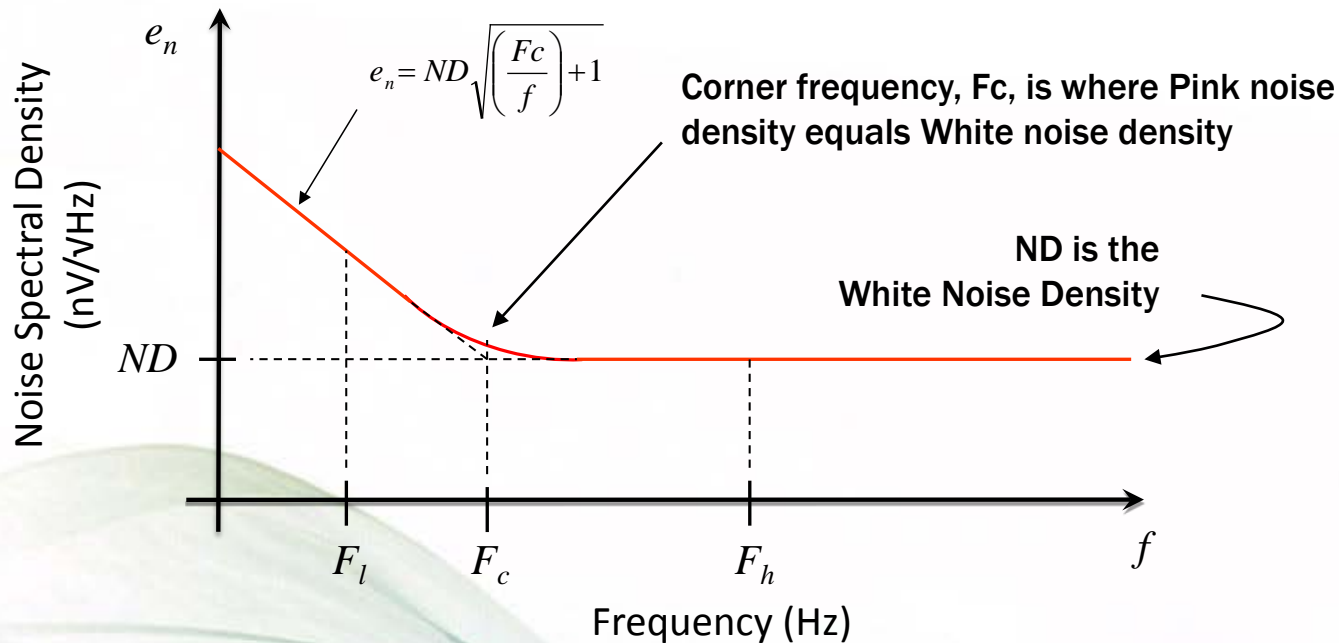

Noise in Semiconductor Devices

1. How noise is specified

- a. Noise amplitude
- b. Noise spectral density

2. Types of noise

- a. White noise sources
- b. Pink noise sources

3. Reading noise specifications

- a. Time domain specs
- b. Frequency domain specs

4. Estimating noise amplitudes

- a. Creating a noise spectral density plot
- b. Finding the noise amplitude

Noise in Semiconductor Devices

Types of Noise: White Noise

White Noise

- Uniform spectral density having equal energy in any given bandwidth
- Distinctive appearance on an oscilloscope

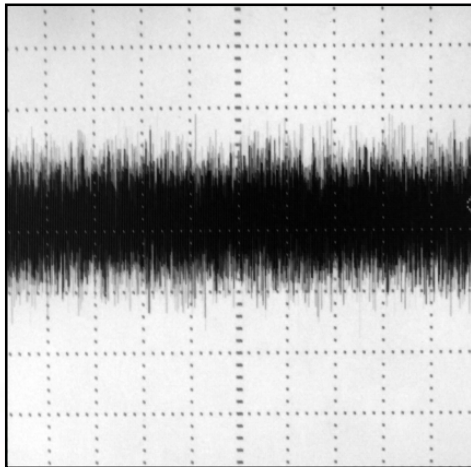

(1 μ s/div)

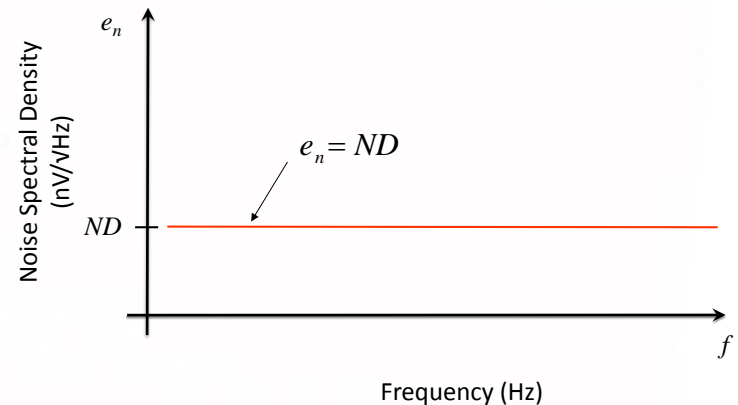

Noise in Semiconductor Devices

Types of Noise: White Noise

Thermal Noise

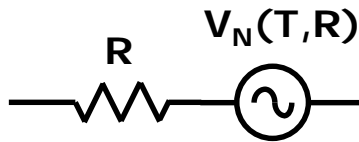

Thermal Noise

- Found in all passive resistive elements
- Caused by the random Brownian motion of electrons in the resistive medium
- Thermal noise density, ND , is defined as,

$$ND = \sqrt{4kRT} \quad \text{nV}/\sqrt{\text{Hz}}$$

Where,

k is Boltzmann's constant

R is resistance in Ohms

T is the temperature in Kelvin

Noise in Semiconductor Devices

Types of Noise: White Noise

Shot Noise

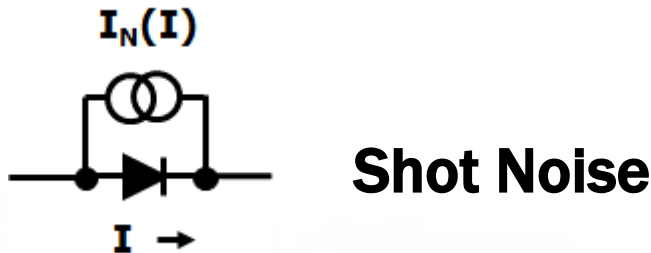

- Generated whenever charge crosses a potential barrier
- Caused by the fact that current flowing cross a junction is not smooth, but is made of individual electrons arriving at random times
- Shot noise density, ND , is defined as,

$$ND = \sqrt{2qI} \text{ nA}/\sqrt{\text{Hz}}$$

Where,

q is the electric charge

I is the current flowing through the barrier

Noise in Semiconductor Devices

Types of Noise: White Noise

Avalanche Noise



- Found in PN junctions operating in reverse breakdown mode, such as Zener diodes
- Caused by carriers developing sufficient energy to dislodge additional carriers through physical impact – resulting in a fluctuation in current
- Like shot noise, avalanche noise requires the flow of current

$$ND = f(I) \text{ nA}/\sqrt{\text{Hz}}$$

Noise in Semiconductor Devices

Types of Noise: Pink Noise

Pink Noise

- Spectral density increases with decreasing frequency. It contains equal amounts of voltage in each decade of bandwidth
- Distinctive appearance on an oscilloscope

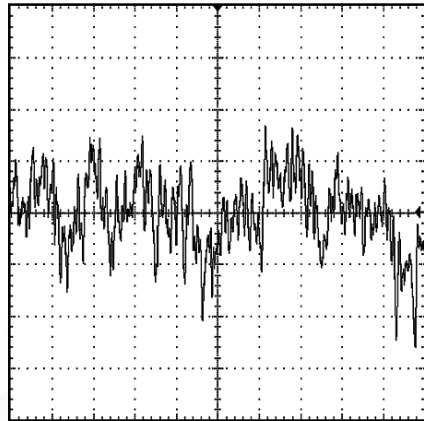

(1s/div, 0.1 to 10Hz BW)

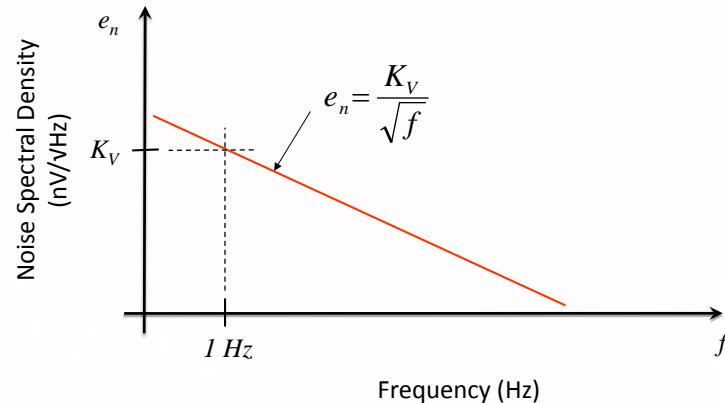

Noise in Semiconductor Devices

Types of Noise: Pink Noise

Flicker Noise

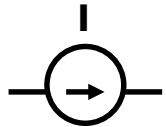

Flicker Noise ($1/f$ Noise)

- Found in all types of transistors and some types of resistors. Always associated with DC current
- Caused by random fluctuations in current due to contamination in semiconductor materials
- Flicker noise density, ND , is defined as,

$$ND = KI \sqrt{\frac{1}{f}} \quad \text{nA}/\sqrt{\text{Hz}}$$

Where,

K is a device constant

I is the DC current

f is the frequency

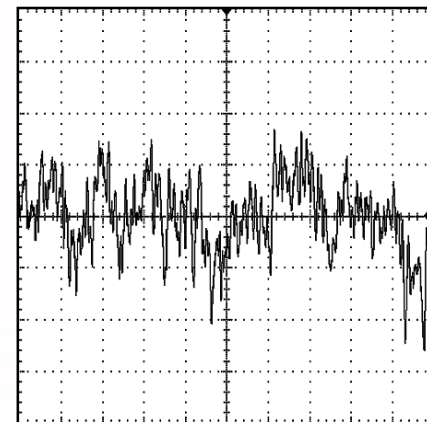

(1s/div, 0.1 to 10Hz BW)

Noise in Semiconductor Devices

Types of Noise: Pink Noise

Popcorn Noise

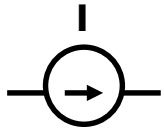

Popcorn Noise

- A low frequency modulation of current. The noise occurs randomly at rates below 100Hz, has a discrete amplitude and a duration between 1ms and 1s
- Caused by the capture and emission of charge carriers. Related to heavy metal ion contamination in the material
- Popcorn noise density, ND , is defined as,

$$ND = KI \sqrt{\frac{1}{1 + \left(\frac{f}{Fc}\right)^2}} \text{ nA}/\sqrt{\text{Hz}}$$

Where,

K is a device constant

I is the DC current

Fc is the corner frequency

f is the frequency

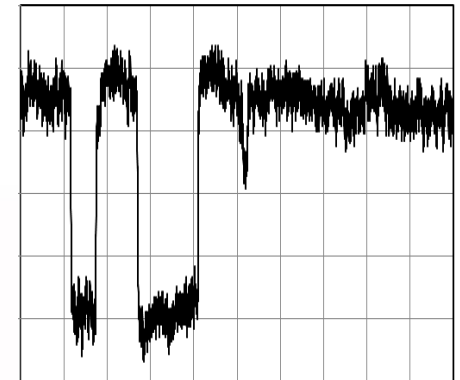

(0.4sec/div)

Noise in Semiconductor Devices

Types of Noise: kT/C

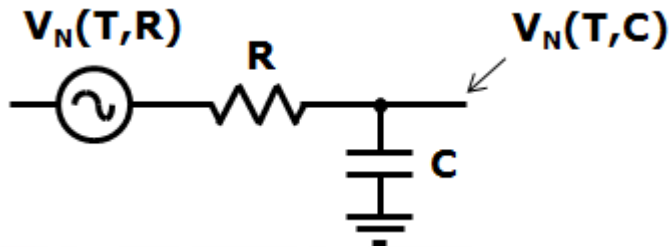

kT/C Noise

kT/C noise is not a fundamental noise source, but is thermal noise in the presence of a filter capacitor. The R terms drops out leaving $V_n = kT/C$.

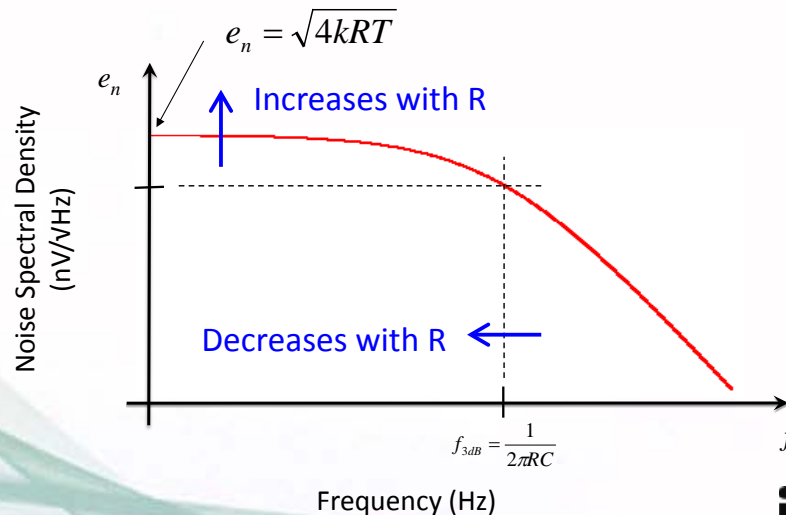
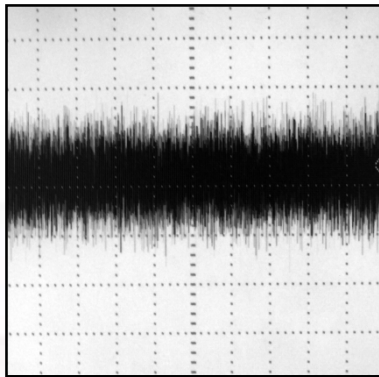

Noise in Semiconductor Devices

1. How noise is specified

- a. Noise amplitude
- b. Noise spectral density

2. Types of noise

- a. White noise sources
- b. Pink noise sources

3. Reading noise specifications

- a. Time domain specs
- b. Frequency domain specs

4. Estimating noise amplitudes

- a. Creating a noise spectral density plot
- b. Finding the noise amplitude

Noise in Semiconductor Devices Reading Noise Specifications

ADCs

DACs

VRefs

Amplifiers

- Electrical Specifications Table**

Electrical Specifications $V_{IN} = 5V$ (1.25V option), $I_{OUT} = 0$, $C_L = 0.1\mu F$ and $C_C = 0.01\mu F$, unless otherwise specified. Boldface limits apply over the operating temperature range, -40 °C to +125 °C.

PARAMETER	DESCRIPTION	CONDITIONS	MIN (Note 7)	TYP	MAX (Note 7)	UNIT
-----------	-------------	------------	--------------	-----	--------------	------

- Typical Performance Curves Section**

Typical Performance Characteristics Curves

$V_{IN} = 3.0V$, $I_{OUT} = 0mA$, $T_A = +25^\circ C$ unless otherwise specified.

Noise in Semiconductor Devices

Reading Noise Specifications

Time Domain Specifications

Noise Voltage Amplitude

ISL21090 Voltage Reference – ES Table

PARAMETER	DESCRIPTION	CONDITIONS	MIN (Note 7)	TYP	MAX (Note 7)	UNIT
e_{np-p}	Output Voltage Noise	$0.1\text{Hz} \leq f \leq 10\text{Hz}$, $V_{OUT} = 7.5\text{V}$		6.2		μV_{P-P}
V_n	Broadband Voltage Noise	$10\text{Hz} \leq f \leq 1\text{kHz}$, $V_{OUT} = 7.5\text{V}$		4.8		μV_{RMS}

- **Peak to Peak, μV_{P-P}**

6.2 μV_{P-P} is the “flicker” or “1/f” noise. It can be identified as flicker noise by the low frequency band (0.1Hz to 10Hz) in the conditions column

- **Root Mean Square, μV_{RMS}**

It is measured over a wider and higher frequency band of 10Hz to 1kHz, where white noise dominates, and 1/f noise is negligible

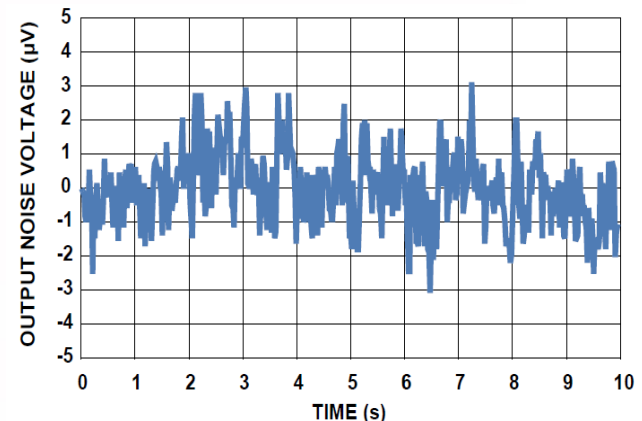

V_{OUT} vs NOISE, 0.1Hz TO 10Hz

Noise in Semiconductor Devices

Reading Noise Specifications

Frequency Domain Specifications

Noise Voltage Spectral Density

ISL21090 Voltage Reference – ES Table

PARAMETER	DESCRIPTION	CONDITIONS	MIN (Note 7)	TYP	MAX (Note 7)	UNIT
e_n	Noise Voltage Density	$f = 1\text{kHz}$, $V_{OUT} = 7.5\text{V}$		150		$\text{nV}/\sqrt{\text{Hz}}$

- **Noise spectral density**
- **Noise density is specified at a particular frequency, called the spot frequency, f**
- **Common spot frequencies include, 1kHz, 10kHz, 100kHz, and 1MHz**
- **Typical performance curve (ISL28108)** →

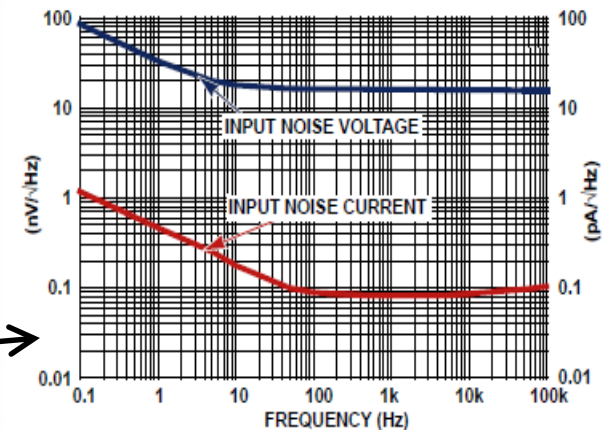

Noise in Semiconductor Devices

1. How noise is specified

- a. Noise amplitude
- b. Noise spectral density

2. Types of noise

- a. White noise sources
- b. Pink noise sources

3. Reading noise specifications

- a. Time domain specs
- b. Frequency domain specs

4. Estimating noise amplitudes

- a. Creating a noise spectral density plot
- b. Calculating the noise

Noise in Semiconductor Devices

Estimating Noise Amplitudes

Here is the key ...

The noise voltage present over any bandwidth is the Root Sum Square (RSS) of the area under the noise spectral density curve, between the upper (F_h) and lower (F_l) frequencies of the band.

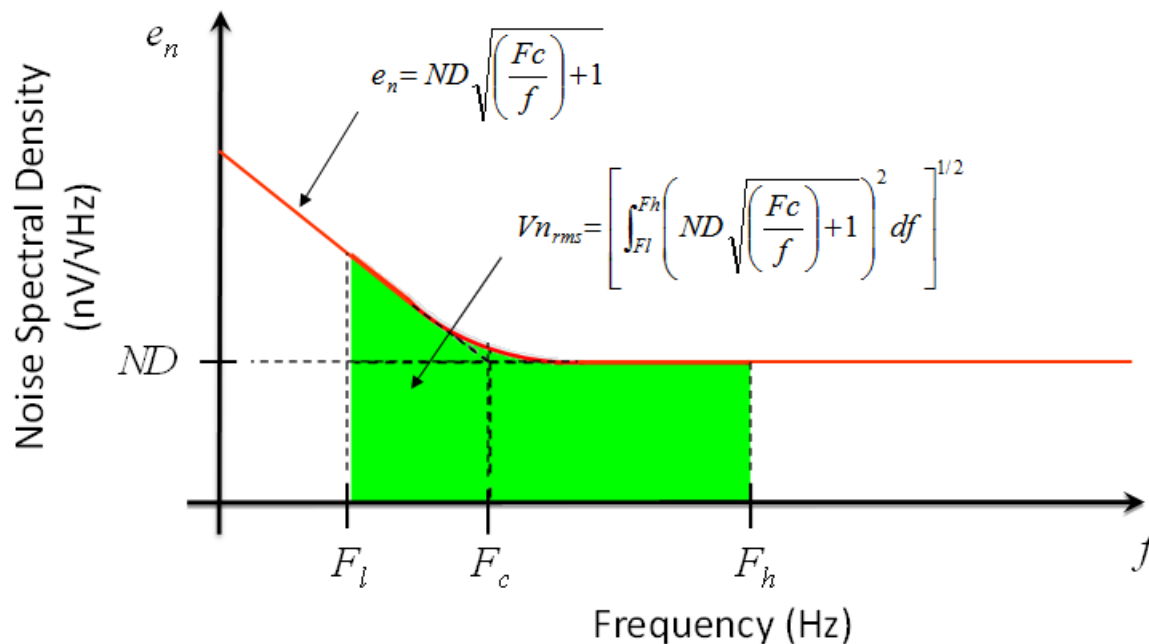

Noise in Semiconductor Devices

Estimating Noise Amplitudes

Simplifying,

$$Vn_{rms} = \left[\int_{Fl}^{Fh} \left(ND \sqrt{\left(\frac{Fc}{f} \right) + 1} \right)^2 df \right]^{1/2} = ND \sqrt{Fc \cdot \ln\left(\frac{Fh}{Fl} \right) + Fh - Fl}$$

The noise voltage can be predicted over any desired frequency band if the noise spectral density (ND) and corner frequency (Fc) are known.

Noise in Semiconductor Devices

Estimating Noise Amplitudes

Thermal Noise Calculator



TNC Calc.exe

A calculator for making quick work of noise calculations

Uses the equations,

$$ND = \sqrt{4kR(T + 273.15)}$$

$$Vn_{rms} = ND \sqrt{Fc \cdot \ln\left(\frac{Fh}{Fl}\right) + Fh - Fl}$$

$$Vn_{pp} = 6.6 \cdot Vn_{rms}$$

All variables can be entered
or found

Variable	Value	Unit
Noise Voltage (Vn)	66.00	μVpp
Noise Voltage (Vn)	10.00	μVrms
White Noise Spectral Density (ND)	31.48	nV/√Hz
Johnson Resistance (R)	60184	Ω
Temperature (Temp)	25.0	C
Upper Frequency (Fh)	100000.0	Hz
Lower Frequency (Fl)	10.0	Hz
1/f Corner Frequency (Fc)	100.0	Hz

Consistent

Buttons: Defaults, Help, Import, Export, Find, Graph, Close

Noise in Semiconductor Devices

Estimating Noise Amplitudes

Thermal Noise Calculator

Description	Name	Value	Unit
Noise Voltage	Vn	66.00	μVpp
Noise Voltage	Vn	10.00	μVrms
White Noise Spectral Density	ND	31.48	$\text{nV}/\sqrt{\text{Hz}}$
Johnson Resistance	R	60184	Ω
Temperature	Temp	25.0	C
Upper Frequency	Fh	100000.0	Hz
Lower Frequency	Fl	10.0	Hz
1/f Corner Frequency	Fc	100.0	Hz

Consistent

Parameters

Message Line

Command Buttons

Consistent Indicator

Defaults Import Find
Help Export Graph Close

Noise in Semiconductor Devices

Estimating Noise Amplitudes

Thermal Noise Calculator Commands

F ind	Alt + F	Find the selected parameter
G raph	Alt + G	Graph the noise spectral density curve specified by the parameters
E xport	Alt + E	Export all parameters to a <u>.cvs</u> file
I mport	Alt + I	Import all parameters from a <u>.cvs</u> file
D efaults	Alt + D	Load the default startup parameter values
H elp	Alt + H	Display the help page
C lose	Alt + C	Close the calculator

“**Consistent**” indicates all parameters are consistent, otherwise “**Inconsistent**” is displayed.

Noise in Semiconductor Devices

Estimating Noise Amplitudes

Typically, datasheets only provide three noise specs in the EP table

1. Noise density (ND)
2. Flicker noise (Vn_{pp})
3. Wideband noise (Vn_{rms})

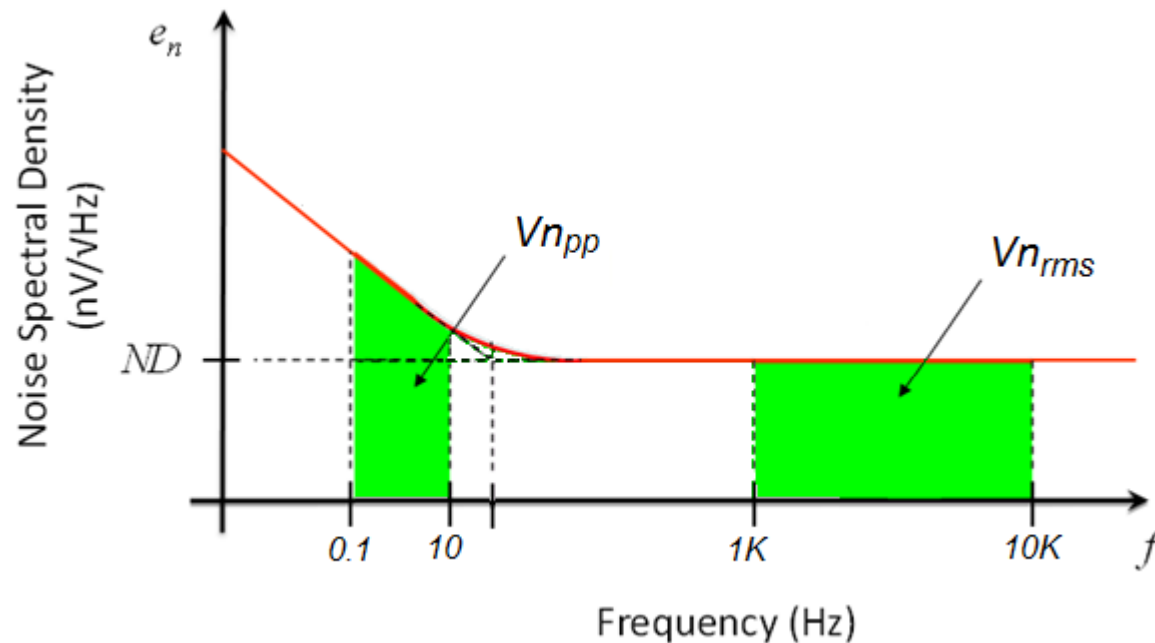

Noise in Semiconductor Devices

Estimating Noise Amplitudes

Example – Customer Question

What is the output noise voltage (V_n) of the ISL21090 voltage reference over the audio band of 20Hz to 20kHz?

We will use the calculator and datasheet to find the answer. We will draw the noise spectral density curve to help us visualize what the calculator is doing.

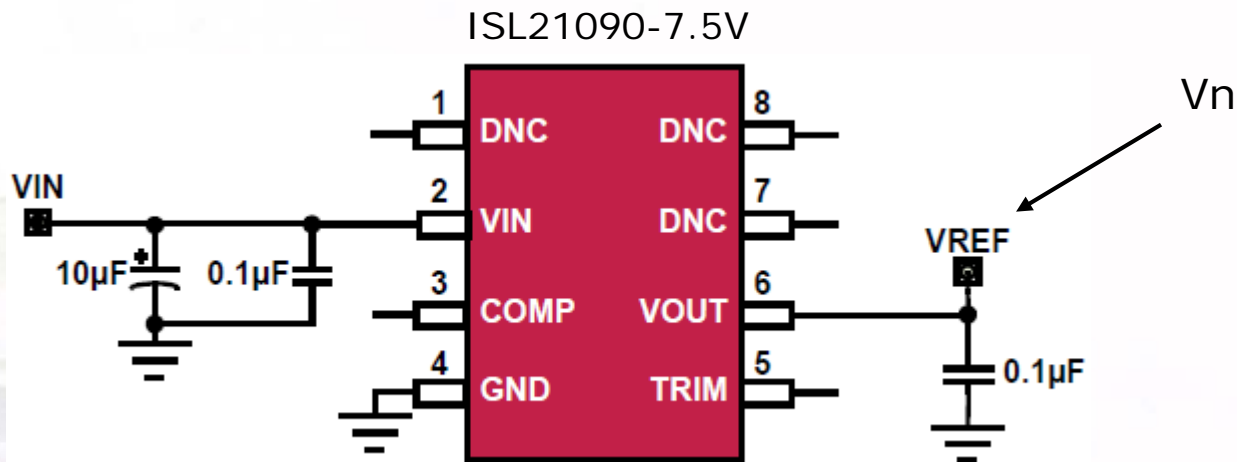

Noise in Semiconductor Devices

Estimating Noise Amplitudes

Drawing the Noise Spectral Density Curve

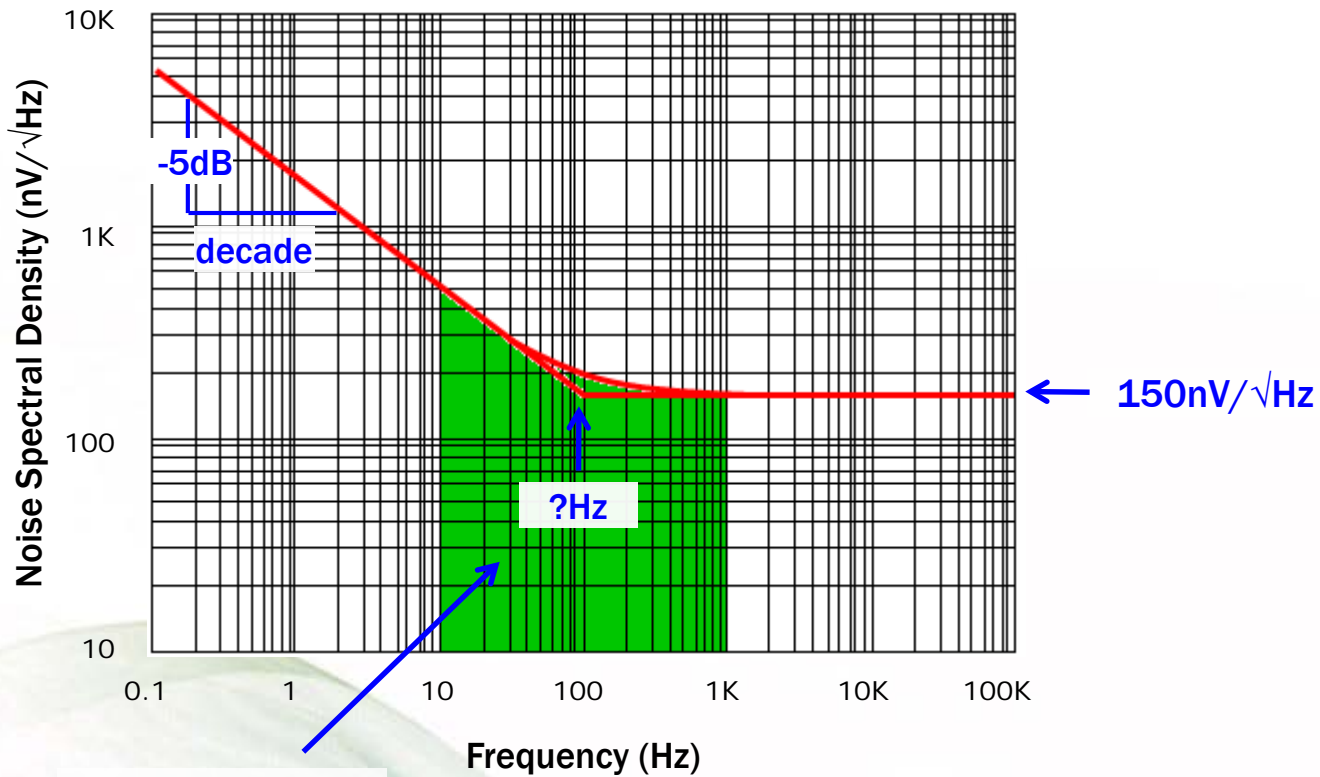

Broadband Noise
4.8 μV_{rms}

Noise in Semiconductor Devices

Estimating Noise Amplitudes

Drawing the Noise Spectral Density Curve – Finding F_c

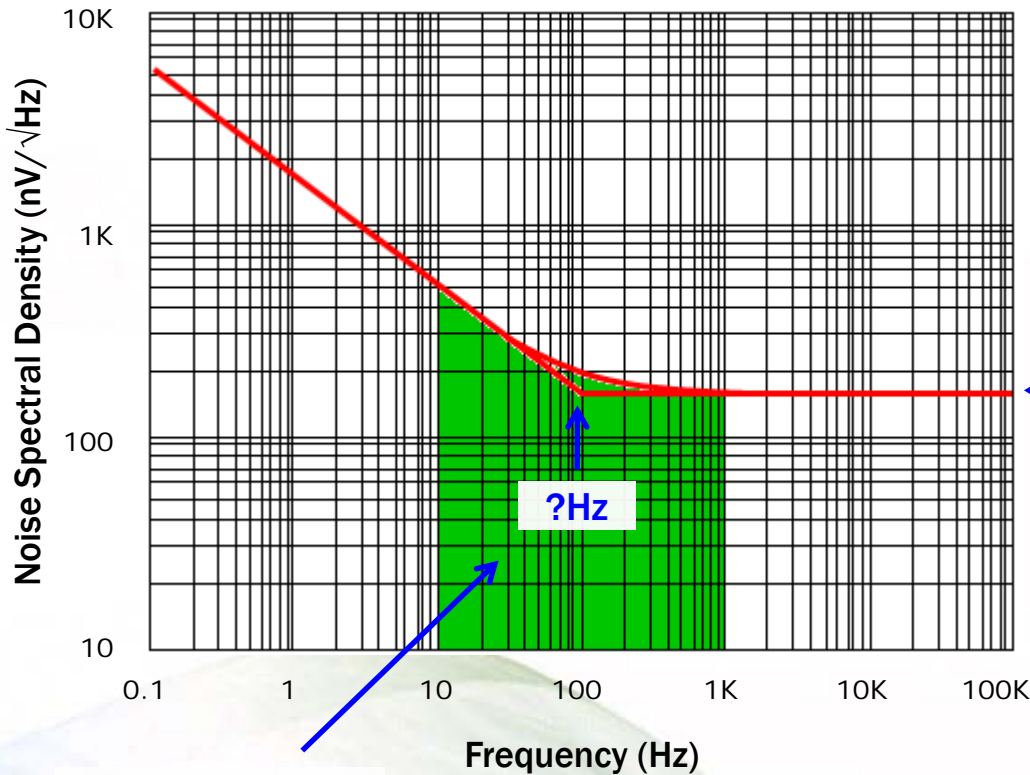

Find F_c from the broadband noise and ND

1. Enter $150\text{nV}/\sqrt{\text{Hz}}$ in ND
2. Enter 10Hz in F_l
3. Enter $1,000\text{Hz}$ in F_h
4. Enter $4.8\mu\text{Vrms}$ in V_n
5. Find F_c

$150\text{nV}/\sqrt{\text{Hz}}$

Thermal Noise Calculator			
Noise Voltage	V_n	31.68	μVpp
Noise Voltage	V_n	4.80	μVrms
White Noise Spectral Density	ND	150.00	$\text{nV}/\sqrt{\text{Hz}}$
Johnson Resistance	R	1366482	Ω
Temperature	Temp	25.0	C
Upper Frequency	F_h	1000.0	Hz
Lower Frequency	F_l	10.0	Hz
1/f Corner Frequency	F_c	7.4	Hz
Consistent			
Defaults		Import	Find
Help		Export	Graph
Close			

Broadband Noise
 $4.8\mu\text{Vrms}$

Noise in Semiconductor Devices

Estimating Noise Amplitudes

Completing the Noise Spectral Density Curve

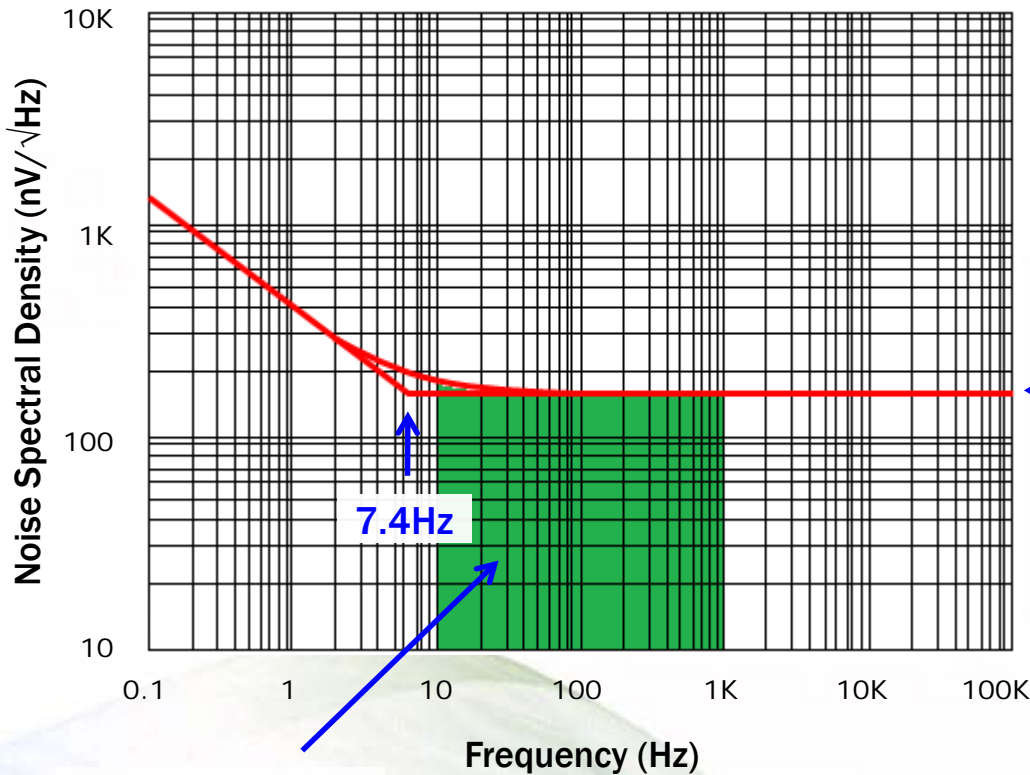

Find F_c from the broadband noise and ND

1. Enter 150nV/√Hz in ND
2. Enter 10Hz in Fl
3. Enter 1,000Hz in Fh
4. Enter 4.8μVrms in Vn
5. Find F_c

150nV/√Hz

Thermal Noise Calculator

Noise Voltage	Vn	31.68	μVpp
Noise Voltage	Vn	4.80	μVrms
White Noise Spectral Density	ND	150.00	nV/√Hz
Johnson Resistance	R	1366482	Ω
Temperature	Temp	25.0	C
Upper Frequency	Fh	1000.0	Hz
Lower Frequency	Fl	10.0	Hz
1/f Corner Frequency	Fc	7.4	Hz

Consistent

Defaults Import Find
Help Export Graph Close

Broadband Noise
4.8μVrms

Noise in Semiconductor Devices

Estimating Noise Amplitudes

Estimating the Output Noise Voltage Over the Full Audio Band

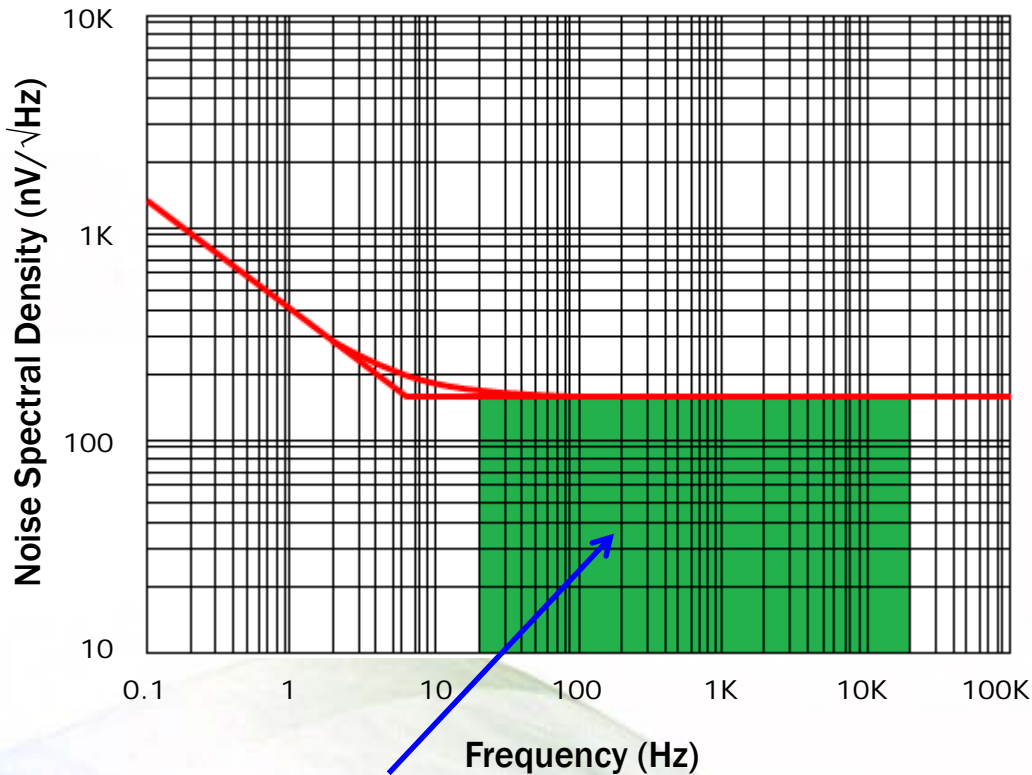

Find the audio band noise, noise not given in the datasheet:

1. Enter 20Hz in Fl
2. Enter 20,000Hz in Fh
3. Enter Vn

Thermal Noise Calculator

Noise Voltage	Vn	140.12	μ Vpp
Noise Voltage	Vn	21.23	μ Vrms
White Noise Spectral Density	ND	150.00	nV/ \sqrt Hz
Johnson Resistance	R	1366482	Ω
Temperature	Temp	25.0	C
Upper Frequency	Fh	20000.0	Hz
Lower Frequency	Fl	20.0	Hz
1/f Corner Frequency	Fc	7.4	Hz

Consistent

Defaults Import Find
Help Export Graph Close

Noise in Semiconductor Devices

Estimating Noise Amplitudes

Verifying the 1/f Noise

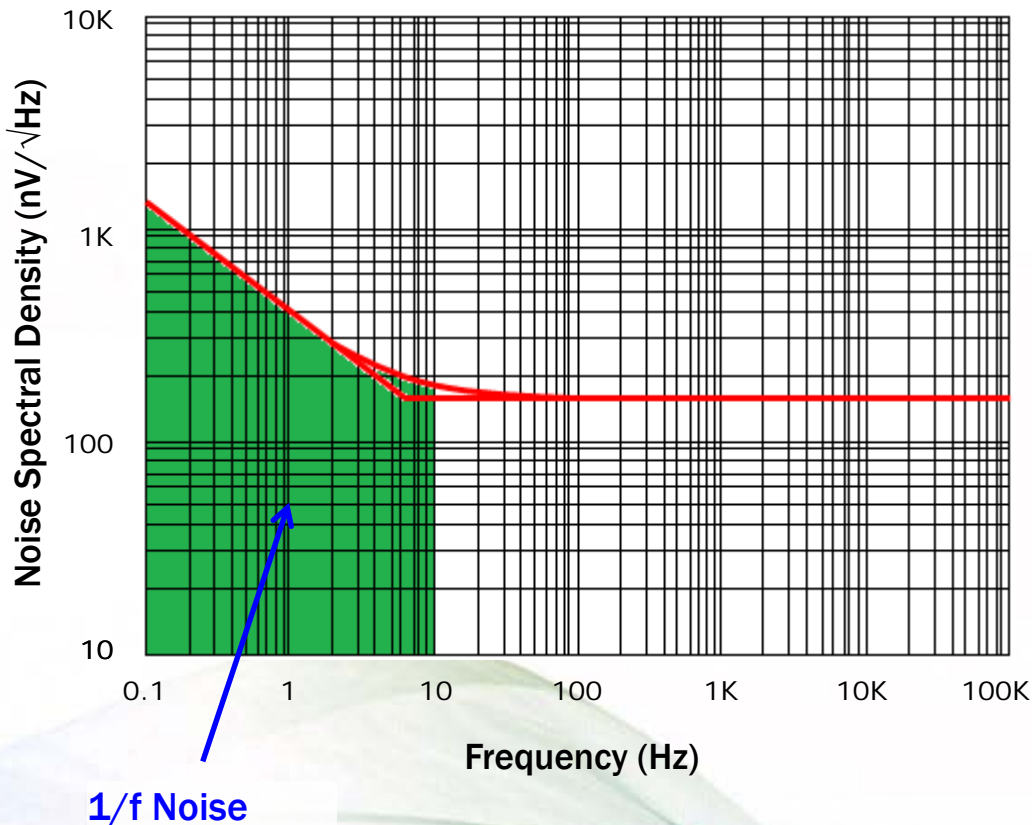

Check the 1/f noise with the datasheet

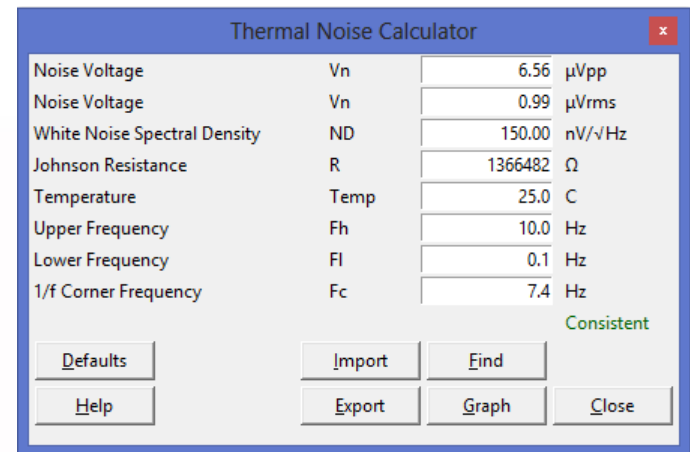

Calculated: 6.6 μVpp

Datasheet: 6.2 μVpp



Noise in Semiconductor Devices

Estimating Noise Amplitudes

Finding the Corner Frequency From a Noise Spectral Density Curve

Curve taken from the MAX6142

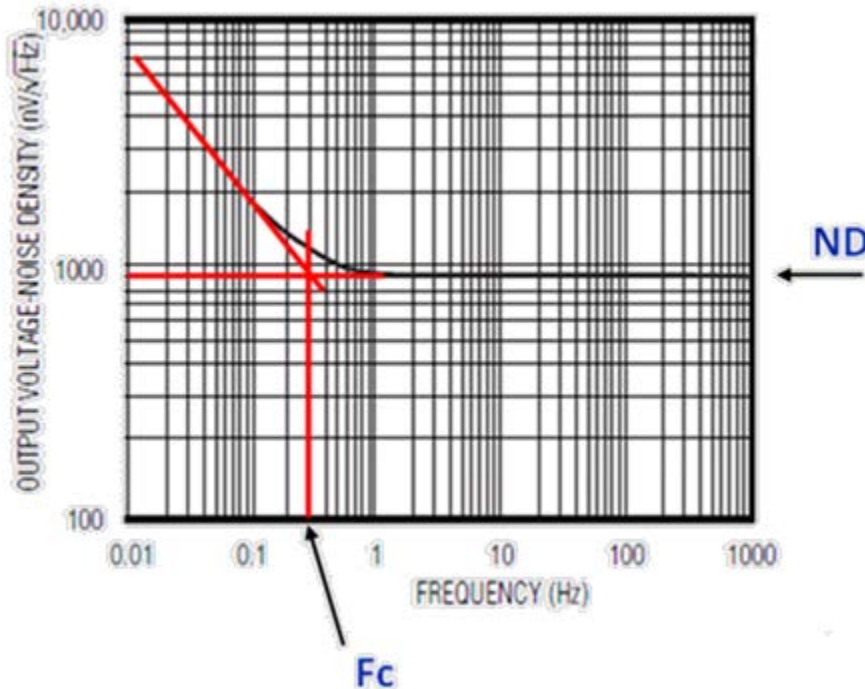

Finding ND and Fc

1. Refer to the performance curve
2. Fc is found at the intersection of the $1/f$ curve and ND, when plotted on a log-log scale.
3. ND = 910nV/√Hz and Fc = 0.3Hz

Noise in Semiconductor Devices

Estimating Noise Amplitudes

Estimating the Output Noise Voltage Over the Full Audio Band

1. Enter $910\text{nV}/\sqrt{\text{Hz}}$ in ND
2. Enter 0.3Hz in F_c
3. Enter 20Hz in F_l
4. Enter $20,000\text{Hz}$ in F_h
5. Find V_n : $128.6\mu\text{Vrms}$

Thermal Noise Calculator		
Noise Voltage	V_n	849.00 μVpp
Noise Voltage	V_n	128.64 μVrms
White Noise Spectral Density	ND	910.00 $\text{nV}/\sqrt{\text{Hz}}$
Johnson Resistance	R	50292620 Ω
Temperature	Temp	25.0 C
Upper Frequency	F_h	20000.0 Hz
Lower Frequency	F_l	20.0 Hz
1/f Corner Frequency	F_c	0.3 Hz
Consistent		
Defaults Import Find		
Help Export Graph Close		

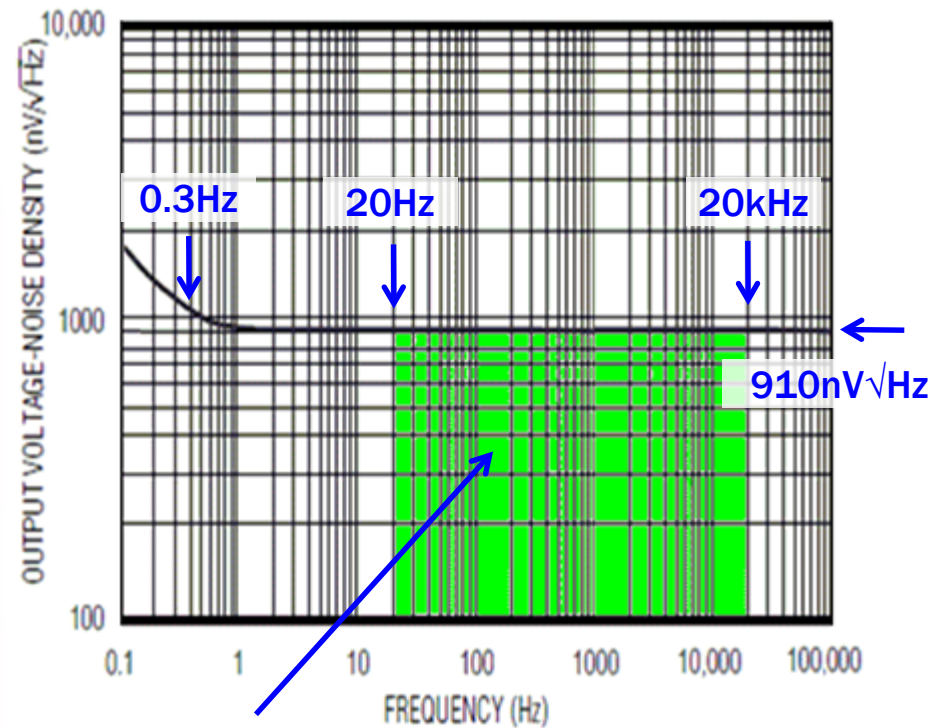

$128.6\mu\text{Vrms}$

Noise in Semiconductor Devices

Estimating Noise Amplitudes

Component Selection Example

Example – Customer Requirement

An audio application requires a Signal to Noise Ratio (SNR) of 105dB with a 5Vpp audio signal. This represents a noise budget of $10\mu\text{V}_{\text{rms}}$. Assuming the DAC noise is negligible, determine if the output noise of the ISL21090-5V meets our noise budget over the audio band of 20Hz to 20kHz.

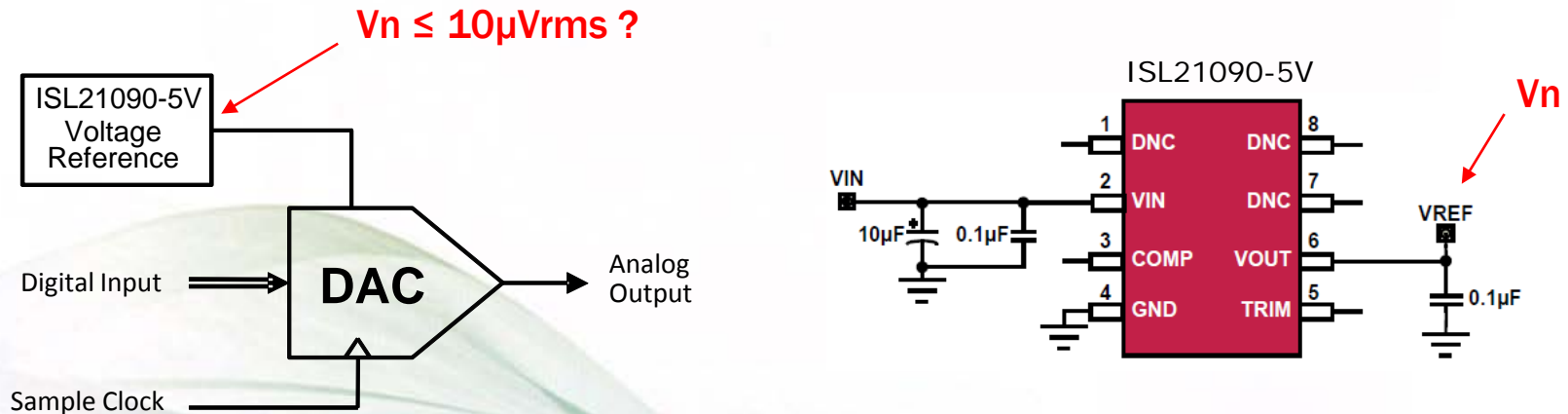

Noise in Semiconductor Devices

How Noise is Specified: Noise Amplitude

Adding Random Noise Sources

All uncorrelated noise sources sum geometrically, in Root Sum Square (RSS) fashion.

$$e_{nT} = \sqrt{e_{n1}^2 + e_{n2}^2 + e_{n3}^2 + \dots + e_{nm}^2}$$

- One term often dominates RMS sums. For example,

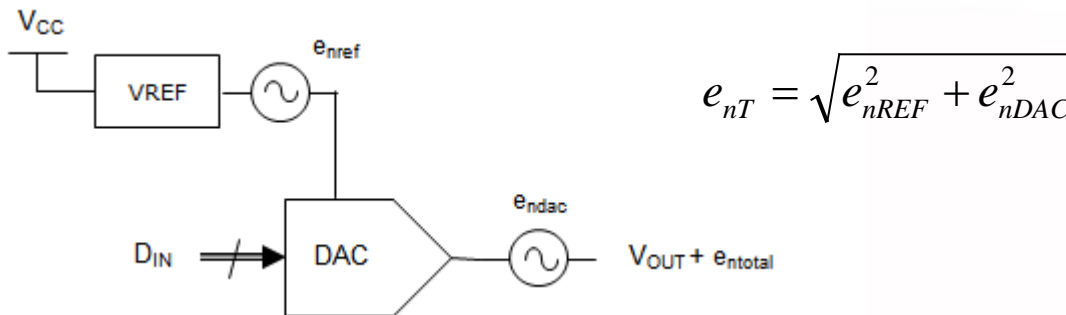

If $e_{nREF} = 300\text{nV}/\sqrt{\text{Hz}}$ and $e_{nDAC} = 100\text{nV}/\sqrt{\text{Hz}}$ then $e_{nT} = 316\text{nV}/\sqrt{\text{Hz}}$

The DAC only contributes $16\text{nV}/\sqrt{\text{Hz}}$!

- When fighting uncorrelated noise - focus on the dominant term

Noise in Semiconductor Devices

Estimating Noise Amplitudes

Drawing the Noise Spectral Density Curve for the ISL21090-5V

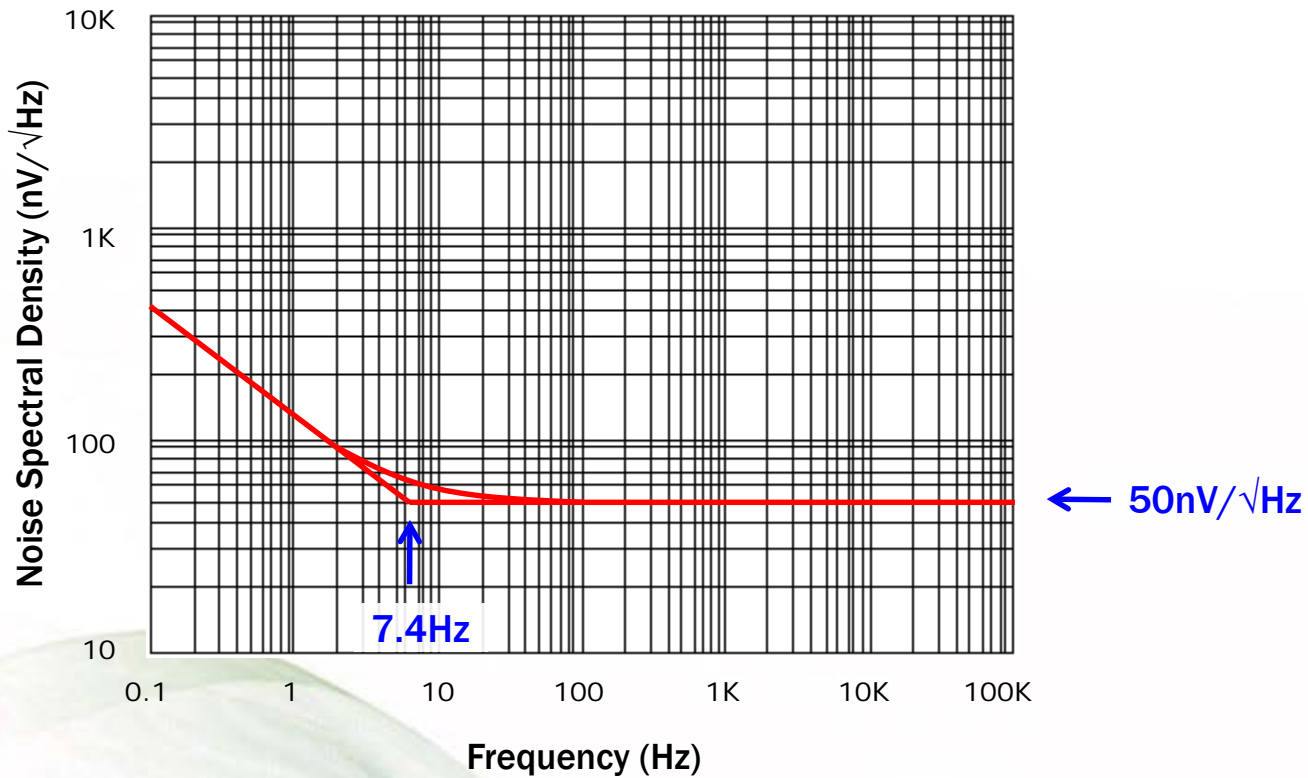

Noise in Semiconductor Devices

Estimating Noise Amplitudes

Estimating the Output Noise Voltage Over the Full Audio Band

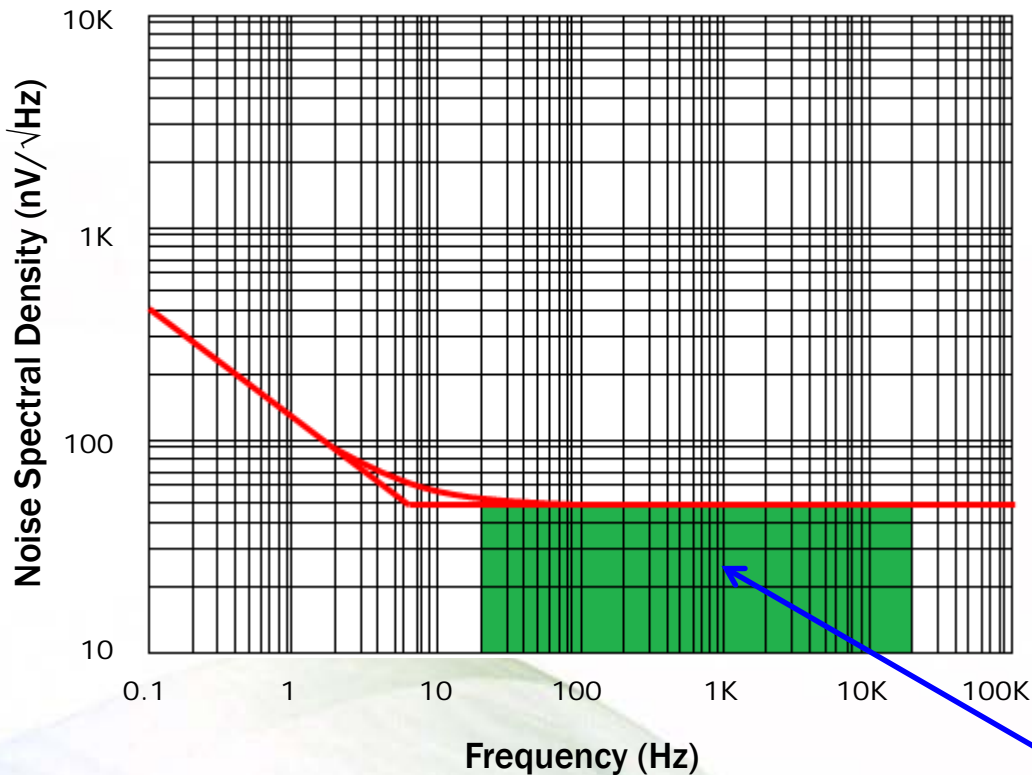

Find the audio band noise - noise not given in the datasheet:

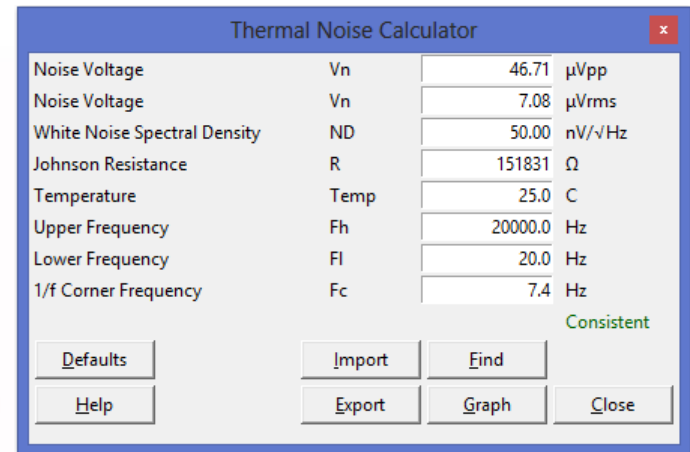

Audio Band Noise
7.08µVrms

Noise in Semiconductor Devices

Estimating Noise Amplitudes

Finding the Maximum Allowable Bandwidth

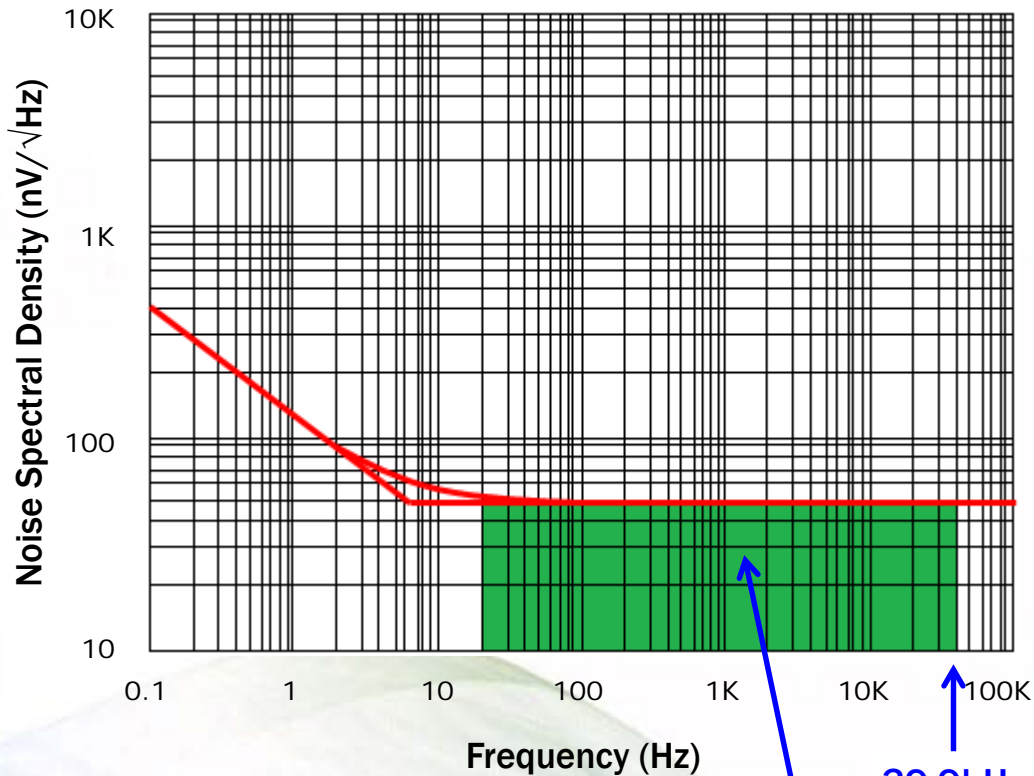

Audio Band Noise
10 μ Vrms

39.9kHz

Find the maximum allowable bandwidth for the noise budget:

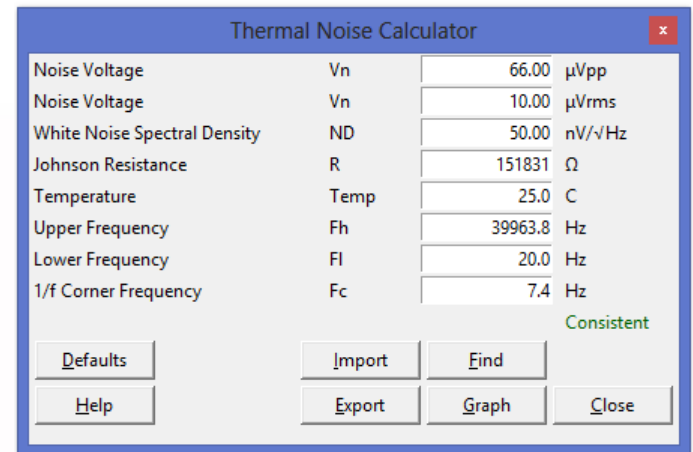

Noise in Data Converters



**Analog to Digital
Converters**



**Digital to Analog
Converters**

In addition to semiconductor noise, data converters have additional sources of noise and distortion. These noise sources include,

- **Quantization noise**
- **Sample jitter**
- **Harmonic distortion**
- **Analog noise**

Noise in Data Converters

- **Noise Sources**

- Quantization noise
- Sample jitter
- Harmonic distortion
- Analog noise

- **How noise is specified in data converters**

- **Selecting the best data converter for a given noise budget**

Noise in Data Converters

Noise Sources Exist in the Signal Chain and Data Converters

Noise can be redistributed among sources within a signal chain as long as the total noise budget is not exceeded.

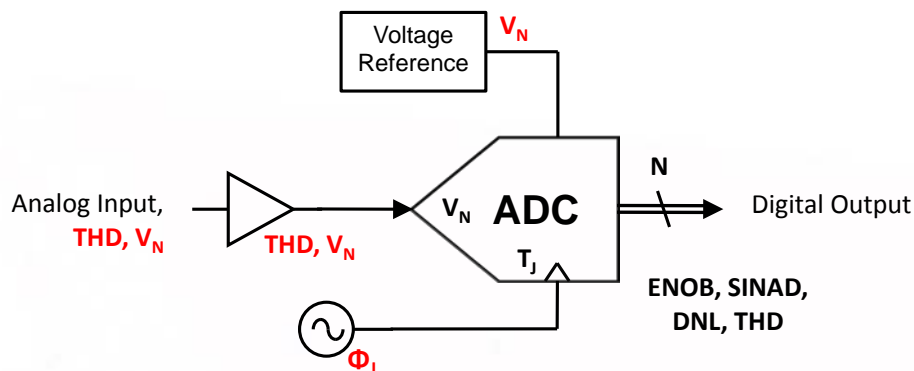

- Additional external noise sources are shown in red.
- Improvements can be made by using a lower noise and distortion input amplifier (ADC) or external driver (DAC), lower noise voltage reference, or a lower jitter sample clock.

Noise in Data Converters

- **Noise Sources**

- Quantization noise
 - Resolution
 - Differential nonlinearity
 - Bandwidth
- Sample jitter
- Harmonic distortion
- Analog noise

- **How noise is specified in data converters**

- **Selecting the best data converter for a given noise budget**

Noise in Data Converters

Quantization Noise - Resolution, N

Increasing resolution (N) means decreasing quantization noise (nq_{PP})

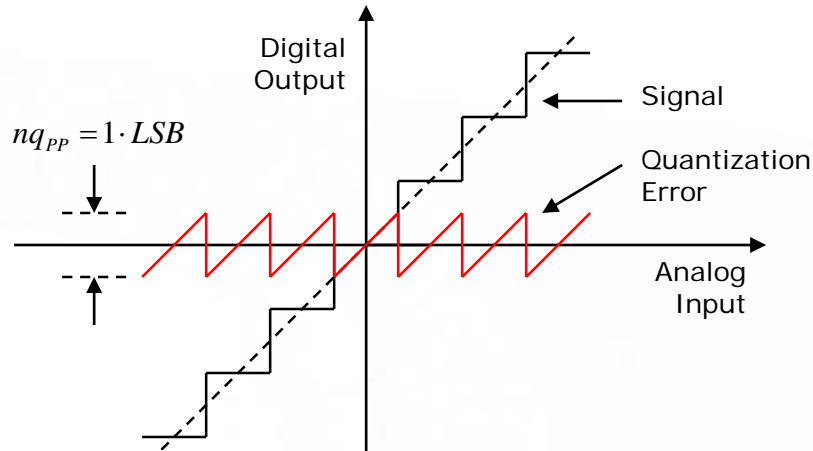

N bit resolution

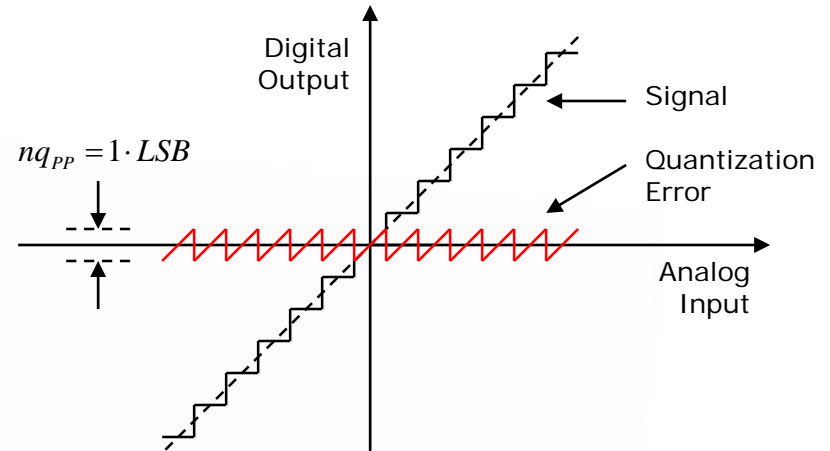

N+1 bit resolution

Least Significant Bit (LSB): $1 \text{ LSB} = \frac{FS}{2^N}$, where FS is the full scale value

Noise in Data Converters

Quantization Noise - Resolution, N

Quantization is the uncertainty that results from dividing a continuous signal into 2^N parts

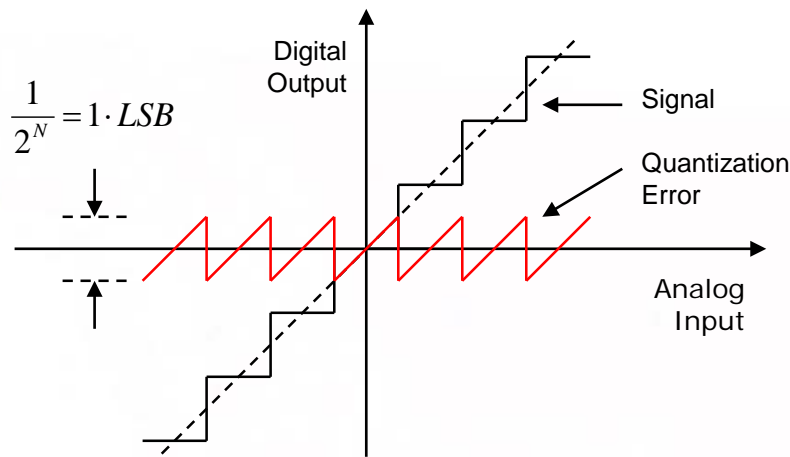

$$n_q = \frac{1}{\sqrt{12}} \text{LSB}_{\text{RMS}}$$

Noise in Data Converters

Quantization Noise - Differential Nonlinearity, DNL

Differential Nonlinearity (DNL) is the deviation of any code width from an ideal 1LSB step. An ideal data converter has a DNL of 0.

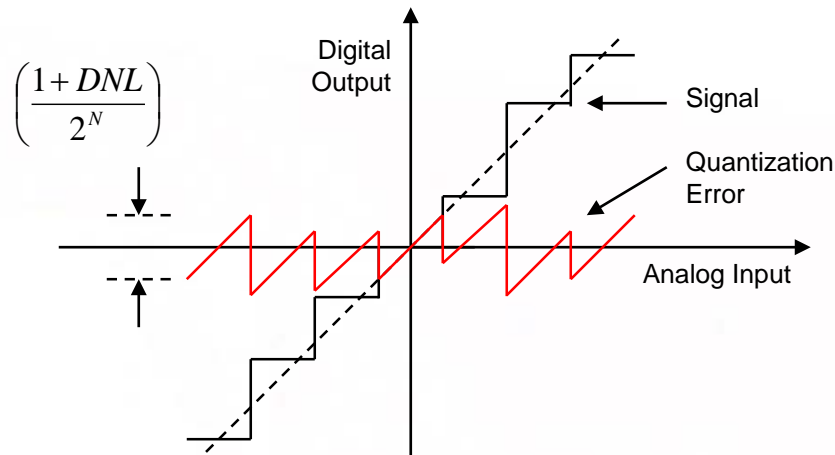

$$n_q = \frac{1 + DNL}{\sqrt{12}} \text{ LSB}_{\text{RMS}}$$

The average DNL of a data converter increases its average quantization error and therefore its quantization noise.

Noise in Data Converters

Quantization Noise - Bandwidth, BW

The quantization noise described up to this point are over the full Nyquist bandwidth (BW).

- Decreasing BW decreases noise

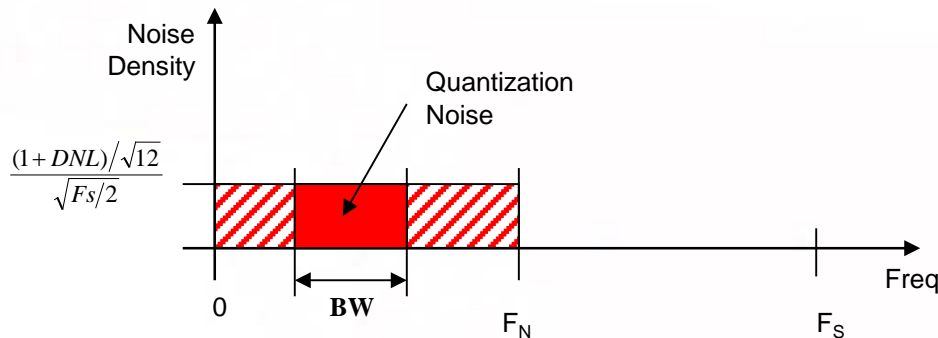

$$n_q = \frac{\sqrt{\frac{BW}{100}} (1 + DNL)}{\sqrt{12}} \text{ LSB}_{\text{RMS}}$$

- If the sample frequency (F_s) and the input signal are harmonically uncorrelated then the noise is Gaussian and is distributed evenly between DC and F_N
- BW is defined here as a percentage of F_N , %

Noise in Data Converters

Quantization Noise - Oversample Rate, OSR

Alternatively, Over Sample Ratio (OSR) can be used in place of BW.

- OSR is the ratio of some higher sample rate $OSR \cdot F_s$ to the original F_s , sampling the full original Nyquist bandwidth. Increasing OSR decreases noise.

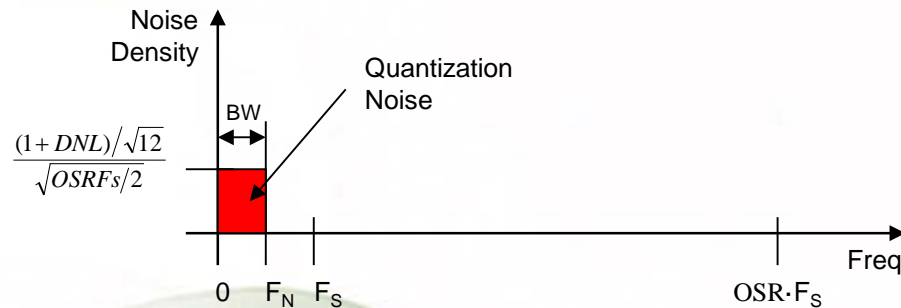

$$n_q = \frac{\sqrt{\frac{1}{OSR}} (1+DNL)}{\sqrt{12}} \text{ LSB}_{\text{RMS}}$$

- Oversampling is used in Sigma-Delta converters to reduce noise.

Noise in Data Converters

- **Noise sources**

- Quantization noise
 - Resolution
 - Differential nonlinearity
 - Bandwidth
- Sample jitter
- Harmonic distortion
- Analog noise

- **How Noise is specified in data converters**

- **Selecting the best data converter for a given noise budget**

Noise in Data Converters

Sample Jitter, Tj

Sample jitter introduces noise when sampling a time varying signal, by producing unwanted variations in sampled values.

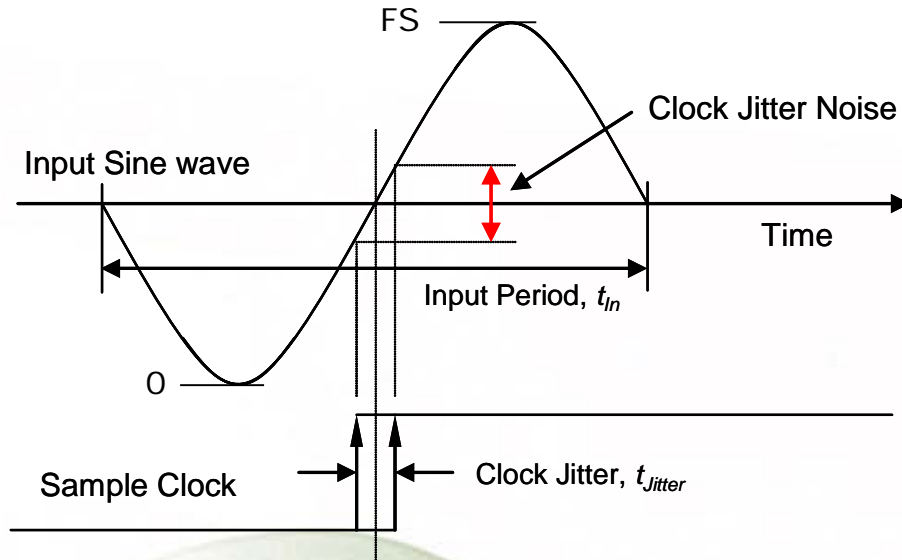

$$n_j = \frac{2\pi}{\sqrt{8}} \cdot \frac{t_{jitter}}{t_{in}} \cdot 2^N \text{ LSB}_{\text{RMS}}$$

Internal source: Sample and Hold (SAH) aperture jitter
External source: Sample clock phase jitter

Noise in Data Converters

Harmonic Distortion

Harmonic distortion is a distortion of a signal caused by the presence of unwanted harmonics

- Nonlinearities within a channel is a common cause of harmonic distortion

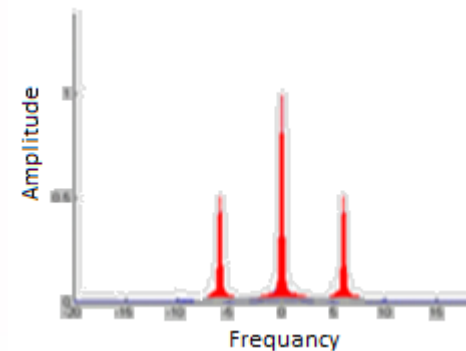
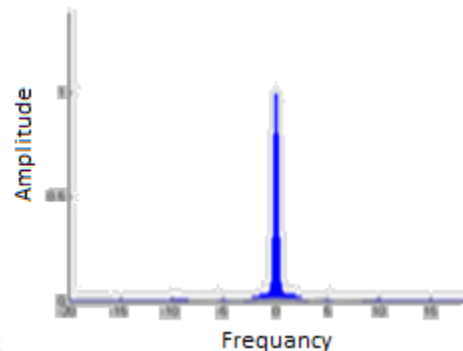
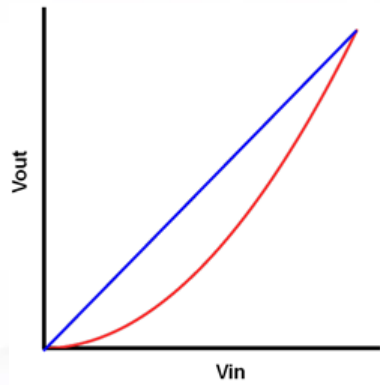

Noise in Data Converters

Harmonic Distortion

Harmonic Distortion in Drivers

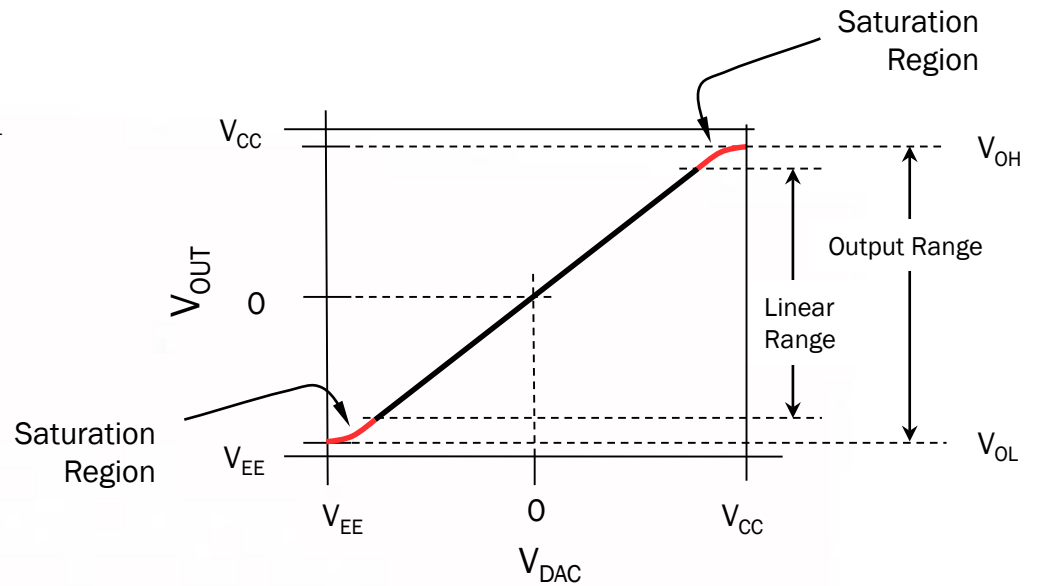
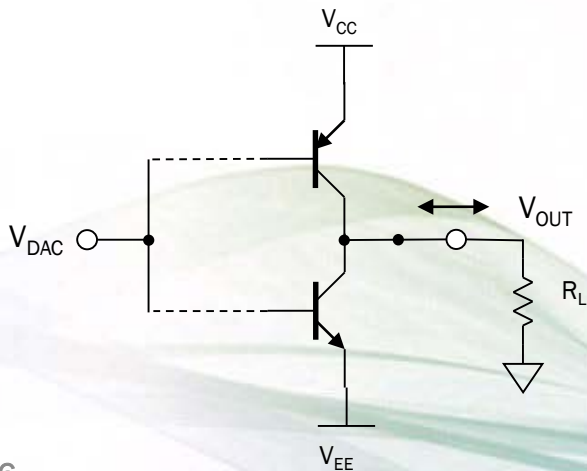
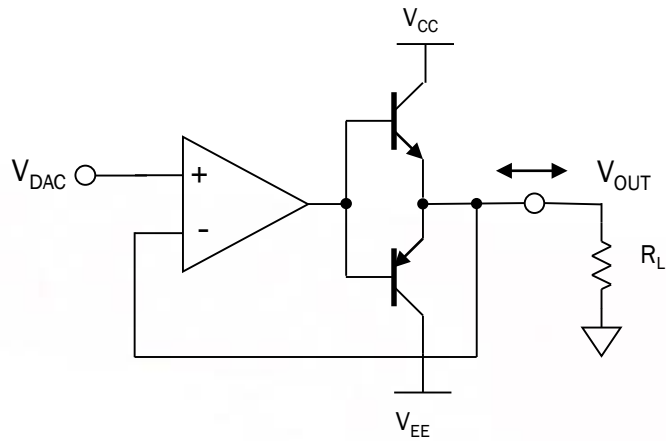

Noise in Data Converters

Total Harmonic Distortion, THD

Total Harmonic Distortion (THD) is a standard measure of harmonic distortion

$$THD = 20 \cdot \log \left(\frac{\sqrt{V_1^2 + V_2^2 + V_3^2 + V_4^2 + V_5^2}}{V_{FS}} \right)$$

THD is defined as the ratio of the RMS sum of the first five harmonics to the full scale RMS signal amplitude (V_{FS})

$$n_{THD} = \sqrt{\sum_{n=1}^5 V_n^2}$$

The total noise contributed by harmonic distortion is the RSS sum of all harmonic components

Noise levels due to THD are related by

$$n_{THD} = \frac{2^N}{\sqrt{8}} \cdot \frac{THD_{\%}}{100} \text{ LSB}_{RMS}$$

When THD is given in % of the FS RMS signal

$$n_{THD} = \frac{2^N}{\sqrt{8}} \cdot 10^{\frac{THD_{dB}}{20}} \text{ LSB}_{RMS}$$

When THD is given in dB of the FS RMS signal

Noise in Data Converters

Total Harmonic Distortion, THD

Example Harmonic Distortion - Showing the 2nd and 3rd harmonic

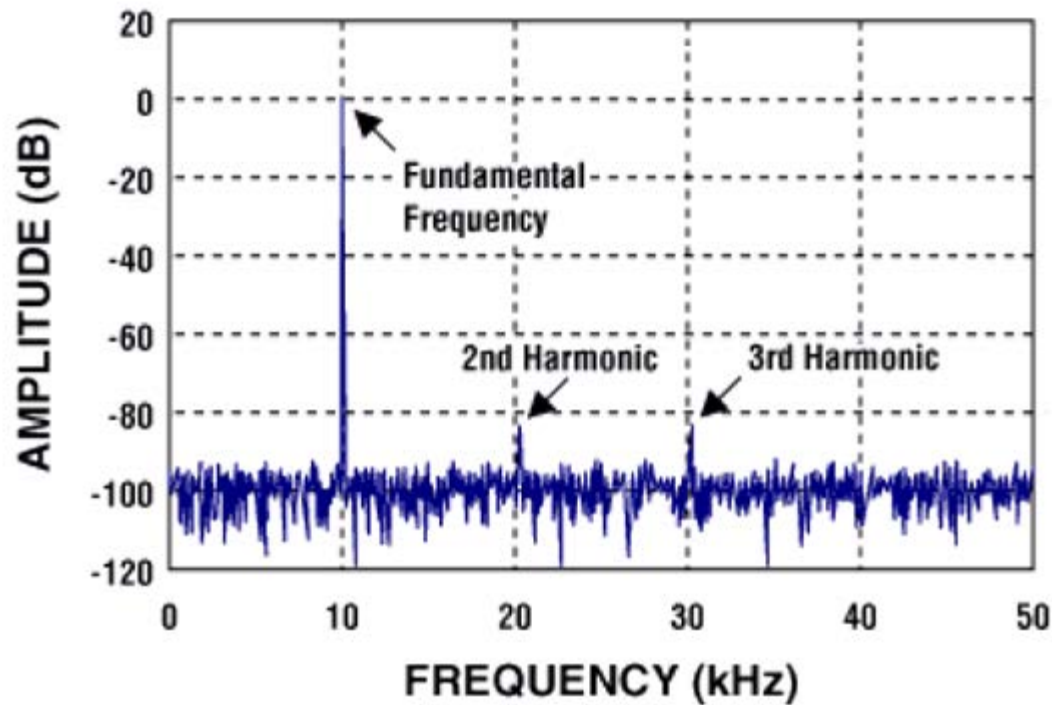

Noise in Data Converters

Harmonic Distortion

Spurious Free Dynamic Range (SFDR)

SFDR is the ratio of the amplitude of the fundamental frequency to the amplitude of the largest magnitude of harmonic or spurious signal component observed over the full bandwidth.

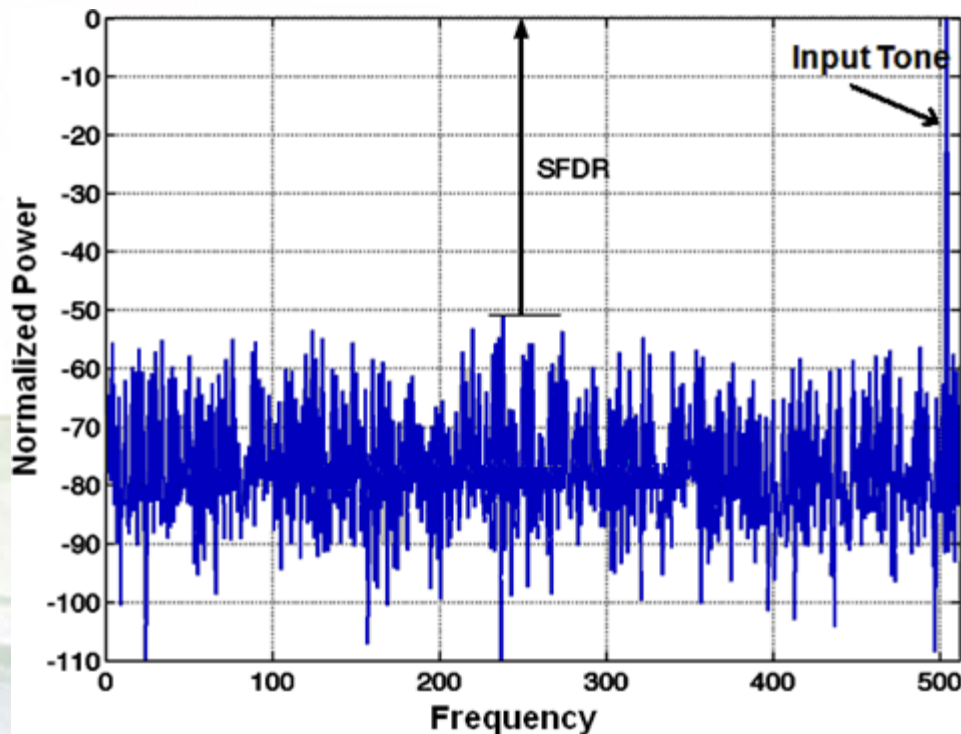

Noise in Data Converters

Harmonic Distortion

Inter-modulation Distortion (IMD)

IMD is the result of two or more signals of different frequencies being mixed together, forming additional signals. Inter-modulation is caused by the nonlinear behavior of the signal processing being used.

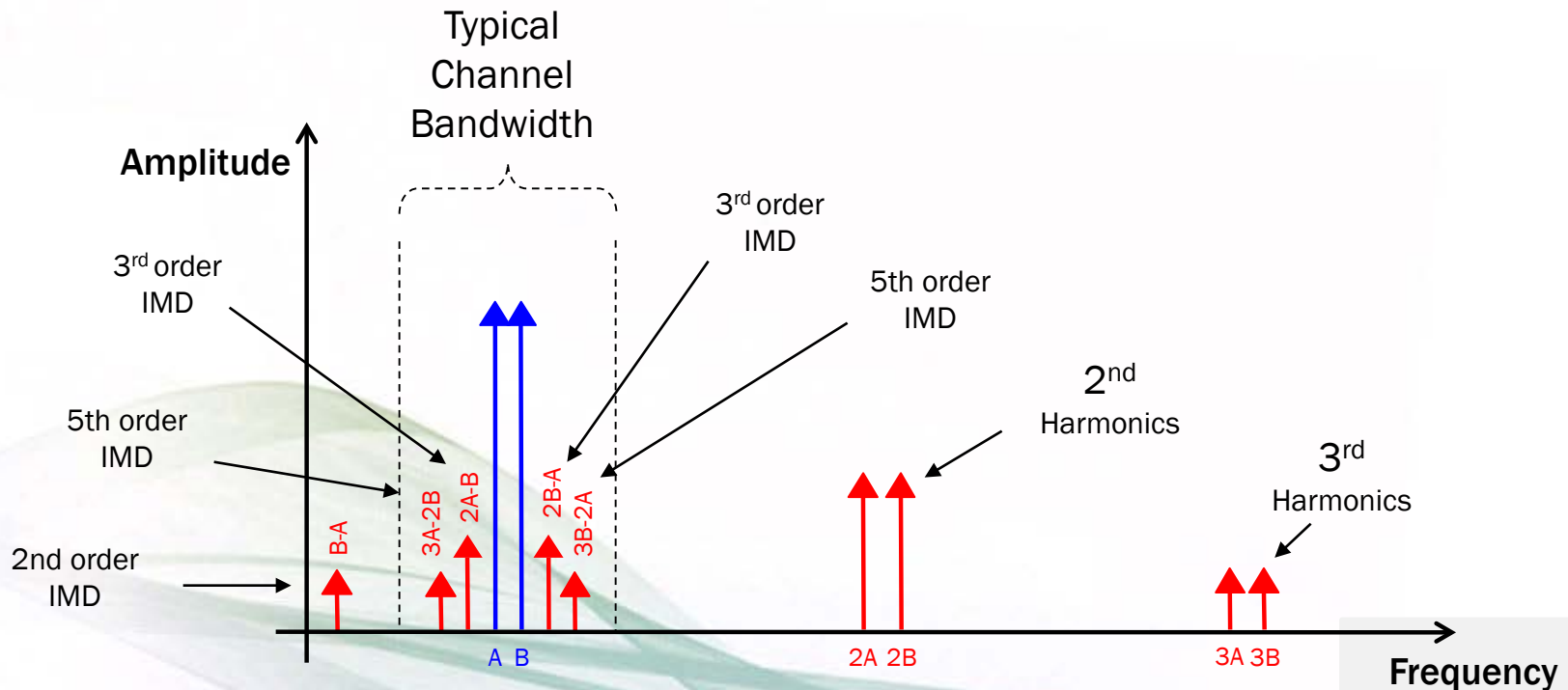

Noise in Data Converters

Glitch Energy

Glitches are short spikes in voltage at the output of a DAC. The “energy” of the glitch is expressed in units of nanovolt-seconds (nV·s).

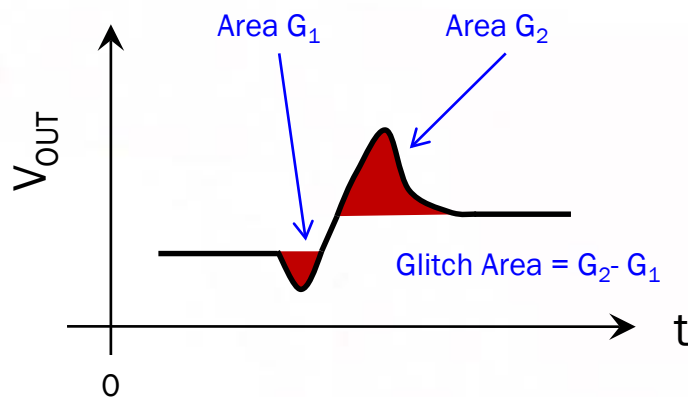

**Bipolar glitch
due to capacitive coupling**

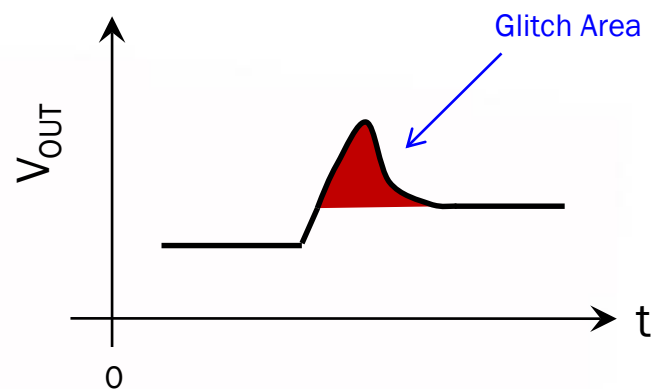

**Unipolar glitch
due to switching skews**

Noise in Data Converters

Analog Noise, V_n

Analog Noise (V_n) is the effective noise referred to the input of an ADC or the output of a DAC

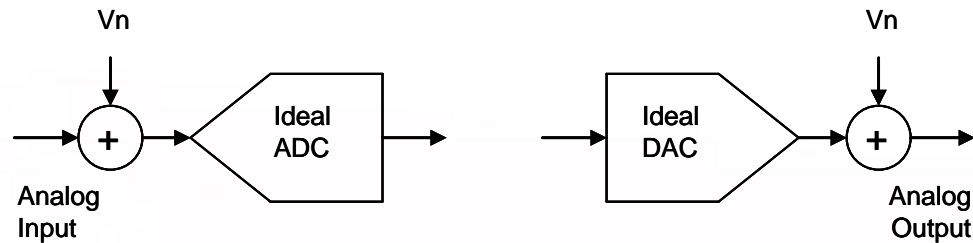

It is the RMS sum of all semiconductor noise sources referred to the analog side of a data converter

$$n_{AN} = V_n \quad \text{LSB}_{\text{RMS}}$$

$$n_{AN} = 6.6 \cdot V_n \quad \text{LSB}_{\text{PP}}$$

Noise in Data Converters

- **Noise sources**

- Quantization noise
 - Resolution
 - Differential nonlinearity
 - Bandwidth
- Sample jitter
- Harmonic distortion
- Analog noise

- **How noise is specified in data converters**

- **Selecting the best data converter for a given noise budget**

Noise in Data Converters

How Noise is Specified In Data Converters

ISL26712 ADC

Electrical Specifications $V_{DD} = +3.0V$ to $+3.6V$, $F_{SCLK} = 18MHz$, $F_S = 1MSPS$, $V_{REF} = 2.0V$; $V_{DD} = +4.75V$ to $+5.25V$, $F_{SCLK} = 18MHz$, $F_S = 1MSPS$, $V_{REF} = 2.5V$; $V_{CM} = V_{REF}$ unless otherwise noted. Typical values are at $T_A = +25^\circ C$. **Boldface limits apply over the operating temperature range, $-40^\circ C$ to $+85^\circ C$.**

SYMBOL	PARAMETER	TEST CONDITIONS	MIN	TYP	MAX	UNITS
DYNAMIC PERFORMANCE						
THD	Total Harmonic Distortion	$F_{IN} = 100kHz$ $V_{DD} = +4.75V$ to $+5.25V$		-84	-76	dB
Δtpd	Aperture Jitter			15		ps
DC ACCURACY						
N	Resolution		12			Bits
DNL	Differential Nonlinearity	Guaranteed no missing codes	-0.95	± 0.3	0.95	LSB

Typical Performance Characteristics Plot \longrightarrow

Average DNL $\approx 0.3LSB$

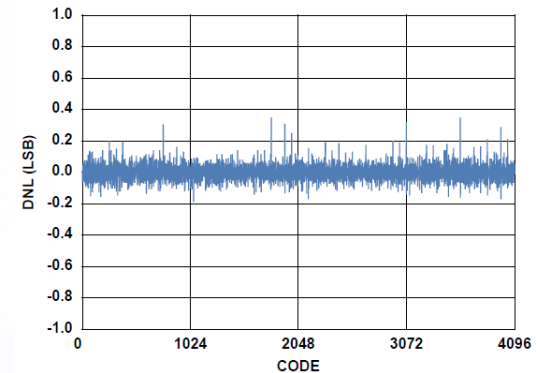

Noise in Data Converters

How Noise is Specified in Data Converters

ELECTRICAL CHARACTERISTICS - MAX5170 DAC

PARAMETER	SYMBOL	CONDITIONS	MIN	TYP	MAX	UNITS
STATIC PERFORMANCE						
Resolution			14			Bits
Differential Nonlinearity	DNL				±1	LSB
Output Noise Voltage				1		LSBp-p
Output Thermal Noise Density		f = 100kHz		80		nV/√Hz

ELECTRICAL CHARACTERISTICS - MAX1062 ADC

PARAMETER	SYMBOL	CONDITIONS	MIN	TYP	MAX	UNITS
DC ACCURACY						
Resolution			14			Bits
Differential Nonlinearity	DNL	No missing codes over temperature		±0.5	±1	LSB
Transition Noise		RMS noise		±0.32		LSBRMS
DYNAMIC SPECIFICATIONS						
Total Harmonic Distortion	THD	1kHz sine wave, 4.096Vp-p		-99	-86	dB
CONVERSION RATE						
Aperture Jitter				<50		ps

Noise in Data Converters

- **Noise sources**
 - Quantization noise
 - Resolution
 - Differential nonlinearity
 - Bandwidth
 - Sample jitter
 - Harmonic distortion
 - Analog noise
- **How noise is specified in data converters**
- **Selecting the best data converter for a given noise budget**

Noise in Data Converters

Selecting the Best Data Converter For Your Noise Budget

What is a noise budget?

A noise budget is the allocation of noise within a signal chain that results in an acceptable SNR at the output.

- SNR is the RMS signal level to the total RMS noise.

$$SNR = 20 \cdot \log \left(\frac{V_{S_{RMS}}}{V_{n_{RMS}}} \right) \text{ dB}$$

Therefore, the method used to determine the acceptable distribution of noise within a signal chain is to evaluate their effect on total SNR.

- Two new specifications used in data converters will be introduced.
 - Signal to Noise and Distortion (SINAD)
 - Effective Number of Bits (ENOB)

Noise in Data Converters

Selecting the Best Data Converter

Signal to Noise and Distortion, SINAD

Pulling it all together...

Data converters combine these noise sources into one parameter called Signal to Noise and Distortion (SINAD)

$$SINAD = -20 \log \sqrt{\underbrace{\frac{2}{3} \left(\frac{\sqrt{\frac{BW}{100}} (1 + DNL)}{2^N} \right)^2}_{\text{Quantization Noise}} + \underbrace{\left(2\pi \frac{Tj}{10^6} \right)^2}_{\text{Sample Jitter Noise}} + \underbrace{\left(\frac{2 \cdot \sqrt{2} \cdot Vn}{2^N} \right)^2}_{\text{Analog Noise}} + \underbrace{\left(\frac{THD\%}{100} \right)^2}_{\text{THD}}} \quad \text{dB}$$

Where,

N is the resolution, in bits

DNL is the average differential nonlinearity, in LSB

BW is the fraction of the full Nyquist bandwidth used, in percent

Tj is the ratio of the RMS jitter of the sample period to the period of a sine wave, in PPM

Vn is the analog noise, in LSB_{RMS}

THD is the total harmonic distortion, in percentage

Noise in Data Converters

Selecting the Best Data Converter

Signal to Noise and Distortion, SINAD

SINAD reduces to the familiar, rule-of-thumb, equation

$$SNR = 6.02N + 1.76dB \quad \text{dB}$$

When,

$$DNL = 0\text{LSB}$$

$$Tj = 0\text{PPM}$$

$$Vn = 0\text{LSB}$$

$$THD = 0\%$$

$$BW = 100\%$$

Together, these parameter values describe the “ideal” data converter.

Noise in Data Converters

Selecting the Best Data Converter

Effective Number of Bits, ENOB

Effective Number of Bits (ENOB) is a data converter's effective resolution from an SNR perspective.

- ENOB is an AC specification and is synonymous with Signal to Noise and Distortion (SINAD). They are related by the equation,

$$ENOB = \frac{SINAD - 10 \cdot \text{Log}\left(\frac{3}{2}\right)}{20 \cdot \text{Log}(2)} \text{ bit}$$

- ENOB says that a data converter has a level of noise and distortion equivalent to an ideal (i.e., noise and distortion free) data converter of ENOB over the full bandwidth.

Noise in Data Converters

Selecting the Best Data Converter

ENOB Calculator



ENOB Calc.exe

A calculator for making quick work of noise calculations in data converters

- All variable can be entered or found
- Uses the equations,

$$ENOB = \frac{SINAD - 10 \cdot \log\left(\frac{3}{2}\right)}{20 \cdot \log(2)}$$

$$SINAD = -20 \log \sqrt{\frac{2}{3} \left[\left(\frac{\sqrt{\frac{BW}{100}} (1 + DNL)}{2^N} \right)^2 + \left(2\pi \frac{Tj}{10^6} \right)^2 + \left(\frac{2 \cdot \sqrt{2} \cdot Vn}{2^N} \right)^2 + \left(\frac{THD_{\%}}{100} \right)^2 \right]}$$

Quantization Noise
Sample Jitter Noise
Analog Noise
THD

Effective Number of Bits	ENOB	14.0	bit
Signal to Noise and Distortion	SINAD	86.0	dB
Resolution	Res	14.0	bit
Bandwidth	BW	100.0	%Fn
Over Sample Ratio	OSR	1.0	xFs
Differential Non Linearity	DNL	0.00	LSB
Clock Jitter	Tj	0.00	PPMrms
Analog Referred Noise	Vn	0.00	LSBrms
Total Harmonic Distortion	THD	0.0000	%
Total Harmonic Distortion	THD	-inf	dB

Consistent

Noise in Data Converters

Selecting the Best Data Converter

ENOB Calculator

Description	Name	Value	Unit
Effective Number of Bits	ENOB	12.2	bit
X Signal to Noise and Distortion	SINAD	75.0	dB
Resolution	Res	14.0	bit
Bandwidth	BW	100.0	%Fn
Over Sample Ratio	OSR	1.0	xFs
Differential Non Linearity	DNL	1.00	LSB
Clock Jitter	Tj	10.00	PPMrms
Analog Referred Noise	Vn	0.50	LSBrms
Total Harmonic Distortion	THD	0.0100	%
Total Harmonic Distortion	THD	-80.0	dB

Consistent

Defaults Import Plot Y vs X Find
Help Export pie Graph Close

Parameters

Message Line

Command Buttons

Consistent Indicator

Noise in Data Converters

Selecting the Best Data Converter

ENOB Calculator Commands

F ind	Alt + F	Find the selected parameter
pie G raph	Alt + G	Graph the noise spectral density curve specified by the parameters
Set X	Alt + X	Select the x-axis parameter to plot
Plot Y vs X	Alt + Y	Select and plot the y-axis parameter with respect to the x-axis parameter
E xport	Alt + E	Export all parameters to a <u>.csv</u> file
I mport	Alt + I	Import all parameters from a <u>.csv</u> file
D efaults	Alt + D	Load the default parameter values
H elp	Alt + H	Display the help page
C lose	Alt + C	Close the calculator

“**Consistent**” indicates all parameters are consistent, otherwise “**Inconsistent**” is displayed.

Noise in Data Converters

Selecting the Best Data Converter

ENOB Calculator Pie Chart

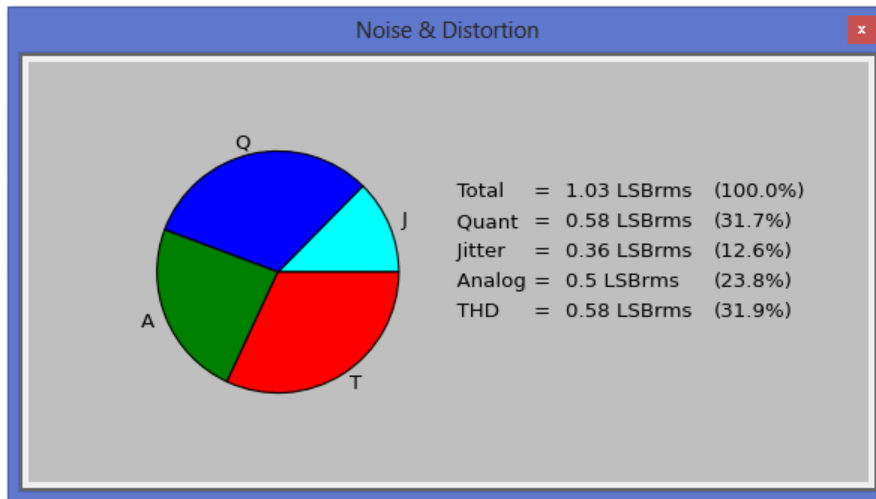

The pie chart shows the contribution of each noise source in the data converter or signal chain.

Noise in Data Converters

Selecting the Best Data Converter

ENOB Calculator Parametric Plot

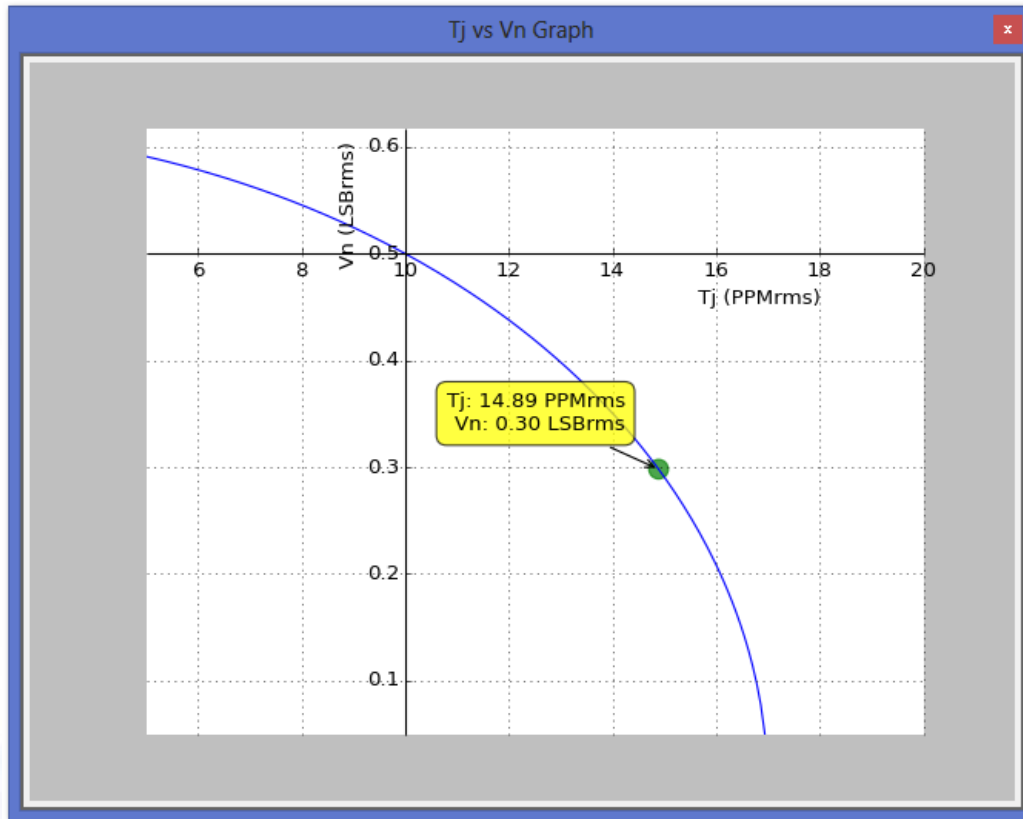

The parametric plot allows trade-offs to be made between noise sources such that the total SINAD remains constant.

Selecting the Best Data Converter for Your Noise Budget

Step 1: Objective

A noise budget is the allocation of noise within a signal chain that results in an acceptable SNR at the output.

Example – Customer Requirement

Select an ADC that exceeds a SINAD of 60dB and has a large signal (full scale) bandwidth of 0 to 500kHz

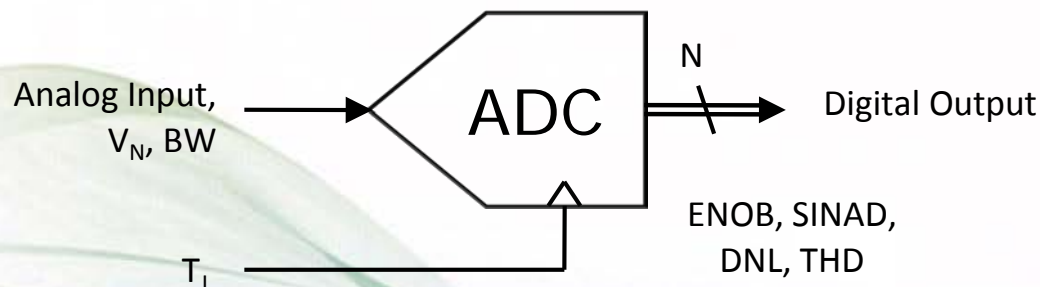

Selecting the Best Data Converter for Your Noise Budget

Step 2: Choose the Resolution

- Start with the rule-of-thumb equation for an ideal data converter to find the resolution required to achieve 60dB SNR.

$$SNR = 6.02N + 1.76dB \rightarrow N = \frac{SNR - 1.76}{6.02}$$

- Using the ENOB calculator,

Effective Number of Bits	ENOB	9.7	bit
Signal to Noise and Distortion	SINAD	60.0	dB
Resolution	Res	9.7	bit
Bandwidth	BW	100.0	%Fn
Over Sample Ratio	OSR	1.0	xFs
Differential Non Linearity	DNL	0.00	LSB
Clock Jitter	Tj	0.00	PPMrms
Analog Referred Noise	Vn	0.00	LSBrms
Total Harmonic Distortion	THD	0.0000	%
Total Harmonic Distortion	THD	-inf	dB

Consistent

60dB SNR → 9.7-bit

Effective Number of Bits	ENOB	10.0	bit
Signal to Noise and Distortion	SINAD	62.0	dB
Resolution	Res	10.0	bit
Bandwidth	BW	100.0	%Fn
Over Sample Ratio	OSR	1.0	xFs
Differential Non Linearity	DNL	0.00	LSB
Clock Jitter	Tj	0.00	PPMrms
Analog Referred Noise	Vn	0.00	LSBrms
Total Harmonic Distortion	THD	0.0000	%
Total Harmonic Distortion	THD	-inf	dB

Consistent

10-bit → 62dB SNR

- Select 10 bits because real ADCs will have a lower SINAD since DNL, Tj, Vn, and THD are always greater than zero and will add noise.

Selecting the Best Data Converter for Your Noise Budget

Step 3: Selecting An Initial ADC

Data Converters → Precision A/D Converters → SAR A/D Converters

[CUSTOMIZE PARAMETERS](#)

[CSV/Excel](#) | [Print](#)

Matching Results: 6 - Data Displayed Below [Refine Data](#)

Device Hide Description	# of Devices/ Channels	Resolution (Bits)	Max Conv Rate (kSPS)	± INL (Integral Non-Linearity) (LSB)	± DNL (Diff. Non-Linearity) (LSB)	SINAD	SFDR	Power Consumption	Analog Supply Voltage (min) (V)	Analog Supply Voltage (max) (V)	Pkg Type	MSRP (\$/1K Units)
ISL26708 8-Bit, 1MSPS SAR ADCs	1	8	1000	.03	.03	49.8 dbFS	-68 dBc	3.75 mW	2.7 V	5.25 V	DFN, SOT	1.29
ISL26710 10-Bit, 1MSPS SAR ADCs	1	10	1000	.1	.1	61.6 dbFS	-82 dBc	3.75 mW	2.7 V	5.25 V	DFN, SOT	2.29
ISL267440 10-Bit 1MSPS SAR ADCs	1	10	1000	0.5	0.5	61 dbFS	-76 dBc	2 mW	2.7 V	5.25 V	MSOP, SOT	2.29
ISL267450 12-Bit, 1MSPS SAR ADCs	1	12	1000	1	0.95	70 dbFS	-82 dBc	3.75 mW	3 V	5.25 V	MSOP, SOIC	3.69
ISL26712 12-Bit, 1MSPS SAR ADCs	1	12	1000	.4	.3	71.4 dbFS	-87 dBc	3.75 mW	2.7 V	5.25 V	DFN, SOT	3.99
ISL267450A 12-Bit 1MSPS SAR ADCs	1	12	1000	1	0.95	70 dbFS	-76 dBc	2 mW	2.7 V	5.25 V	MSOP, SOT	3.99

Selecting The Best Data Converter for Your Noise Budget

Step 3: Selecting An Initial ADC

ISL26712, ISL26710, ISL26708

Electrical Specifications $V_{DD} = +3.0V$ to $+3.6V$, $F_{SCLK} = 18MHz$, $F_S = 1MSPS$, $V_{REF} = 2.0V$; $V_{DD} = +4.75V$ to $+5.25V$, $F_{SCLK} = 18MHz$, $F_S = 1MSPS$, $V_{REF} = 2.5V$; $V_{CM} = V_{REF}$ unless otherwise noted. Typical values are at $T_A = +25^\circ C$. **Boldface limits apply over the operating temperature range, $-40^\circ C$ to $+85^\circ C$.**

SYMBOL	PARAMETER	TEST CONDITIONS	ISL26712			ISL26710			ISL26708			UNITS
			MIN (Note 10)	TYP	MAX (Note 10)	MIN (Note 10)	TYP	MAX (Note 10)	MIN (Note 10)	TYP	MAX (Note 10)	
DYNAMIC PERFORMANCE												
THD	Total Harmonic Distortion	$F_{IN} = 100kHz$ $V_{DD} = +4.75V$ to $+5.25V$		-84	-76		-82	-74		-75	-60	dB
		$F_{IN} = 100kHz$ $V_{DD} = +3.0V$ to $+3.6V$		-84	-74		-82	-72		-73	-60	dB
Δt_{pd}	Aperture Jitter			15		15			15		ps	

DC ACCURACY												
N	Resolution		12			10			8			Bits
INL	Integral Nonlinearity		-1	± 0.4	1	-0.5	± 0.1	0.5	-0.2	± 0.03	0.2	LSB
DNL	Differential Nonlinearity	Guaranteed no missing codes	-0.95	± 0.3	0.95	-0.5	± 0.1	0.5	-0.2	± 0.03	0.2	LSB

N = 10-bit

DNL = 0.1LSB

$V_n = 0LSB_{RMS}$

THD = -82dB

$T_j = 15ps$

Selecting The Best Data Converter for Your Noise Budget

Step 4: Calculating SINAD

Expressing Tj in ppm

The calculator defines Sample Jitter, Tj, as the ratio of the RMS jitter of the sample clock to the period of a full scale sine wave, in PPM.

$$Tj = \frac{t_{Jitter}}{t_{In}} \cdot 10^6$$

where,

$$t_{Jitter} = 15\text{ps}$$

$$t_{In} = 1/500\text{kHz} = 2\mu\text{s}$$

Therefore,

$$Tj = \frac{15 \cdot 10^{-12}}{2 \cdot 10^{-6}} \cdot 10^6 = 7.5 \text{ PPM}_{rms}$$

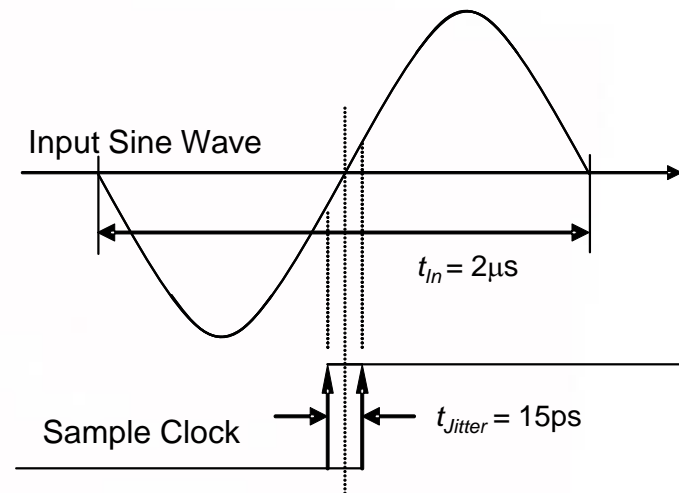

Selecting the Best Data Converter for Your Noise Budget

Step 4: Calculating SINAD

Enter the ISL26710's parameters into the calculator:

1. **N = 10-bit**
2. **DNL = 0.1LSB**
3. **Tj = 7.5PPM**
4. **Vn = 0.00LSB**
5. **THD = -84dB**

Effective Number of Bits	ENOB	9.9	bit
Signal to Noise and Distortion	SINAD	61.1	dB
Resolution	Res	10.0	bit
Bandwidth	BW	100.0	%Fn
Over Sample Ratio	OSR	1.0	xFs
Differential Non Linearity	DNL	0.10	LSB
Clock Jitter	Tj	7.50	PPMrms
Analog Referred Noise	Vn	0.00	LSBrms
Total Harmonic Distortion	THD	0.0063	%
Total Harmonic Distortion	THD	-84.0	dB

Consistent

We find SINAD is **61.1dB**
It meets our target with only a **1.1dB (14%)** margin.

In practice, additional margin is needed because:

1. Typical values were used rather than Max (worst case)
2. Have not allowed for the presence of additional noise sources

Selecting the Best Data Converter for Your Noise Budget

Step 4: Calculating SINAD

Enter the ISL26710's worst case parameters into the calculator:

1. $N = 10$ -bit
2. $DNL = 0.5$ LSB
3. $T_j = 7.5$ PPM
4. $V_n = 0.00$ LSB
5. $THD = -72$ dB

Effective Number of Bits	ENOB	9.4	bit
Signal to Noise and Distortion	SINAD	58.3	dB
Resolution	Res	10.0	bit
Bandwidth	BW	100.0	%Fn
Over Sample Ratio	OSR	1.0	xFs
Differential Non Linearity	DNL	0.50	LSB
Clock Jitter	Tj	7.50	PPMrms
Analog Referred Noise	Vn	0.00	LSBrms
Total Harmonic Distortion	THD	0.0251	%
Total Harmonic Distortion	THD	-72.0	dB

Consistent

We find SINAD is 58.3dB, below the 60dB budget.

Selecting the Best Data Converter for Your Noise Budget

Step 5: Examining the Noise Distribution

By examining the relative noise and distortions levels, it is seen where improvements can be made.

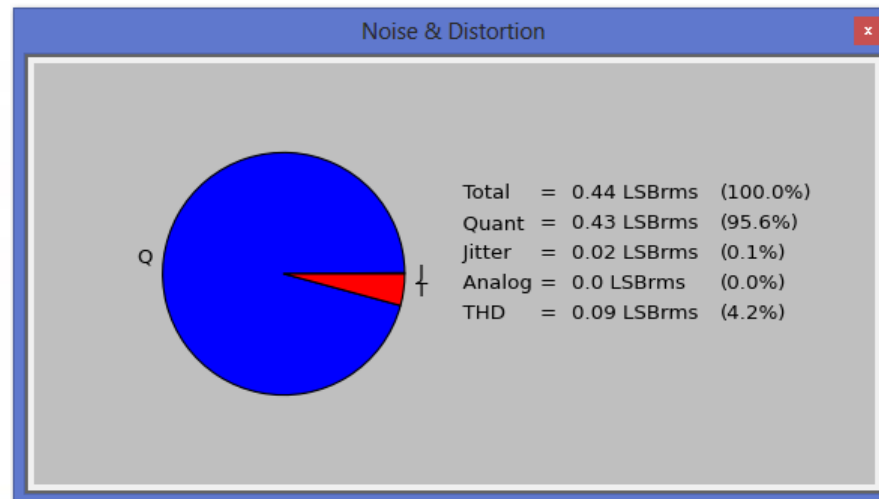

- Quantization noise is the largest contributor to the total noise and distortion.
- Additional improvements can be made by selecting the 12-bit version of the same device, the ISL26712, and thereby reduce the quantization noise.

Selecting the Best Data Converter for Your Noise Budget

Step 6: Reducing the Quantization Noise

ISL26712, ISL26710, ISL26708

Electrical Specifications $V_{DD} = +3.0V$ to $+3.6V$, $F_{SCLK} = 18MHz$, $F_S = 1MSPS$, $V_{REF} = 2.0V$; $V_{DD} = +4.75V$ to $+5.25V$, $F_{SCLK} = 18MHz$, $F_S = 1MSPS$, $V_{REF} = 2.5V$; $V_{CM} = V_{REF}$, unless otherwise noted. Typical values are at $T_A = +25^\circ C$. **Boldface limits apply over the operating temperature range, $-40^\circ C$ to $+85^\circ C$.**

SYMBOL	PARAMETER	TEST CONDITIONS	ISL26712			ISL26710			ISL26708			UNITS
			MIN (Note 10)	TYP	MAX (Note 10)	MIN (Note 10)	TYP	MAX (Note 10)	MIN (Note 10)	TYP	MAX (Note 10)	
DYNAMIC PERFORMANCE												
THD	Total Harmonic Distortion	$F_{IN} = 100kHz$ $V_{DD} = +4.75V$ to $+5.25V$		-84	-76		-82	-74		-75	-60	dB
		$F_{IN} = 100kHz$ $V_{DD} = +3.0V$ to $+3.6V$		-84	-74		-82	-72		-73	-60	dB
Δt_{pd}	Aperture Jitter			15			15			15		ps

DC ACCURACY												
N	Resolution		12			10			8			Bits
INL	Integral Nonlinearity		-1	± 0.4	1	-0.5	± 0.1	0.5	-0.2	± 0.03	0.2	LSB
DNL	Differential Nonlinearity	Guaranteed no missing codes	-0.95	± 0.3	0.95	-0.5	± 0.1	0.5	-0.2	± 0.03	0.2	LSB

N = 12-bit

DNL = 0.95LSB

$V_n = 0LSB_{RMS}$

THD = -74dB

$T_j = 15ps$

Selecting the Best Data Converter for Your Noise Budget

Step 6: Reducing the Quantization Noise

Enter the ISL26712's worst case noise parameters into the calculator:

1. $N = 12\text{-bit}$
2. $DNL = 0.5\text{LSB}$
3. $T_j = 7.5\text{PPM}$
4. $V_n = 0.0\text{LSB}$
5. $THD = -74\text{dB}$

Effective Number of Bits	ENOB	11.1	bit
Signal to Noise and Distortion	SINAD	68.8	dB
Resolution	Res	12.0	bit
Bandwidth	BW	100.0	%Fn
Over Sample Ratio	OSR	1.0	xFs
Differential Non Linearity	DNL	0.50	LSB
Clock Jitter	Tj	7.50	PPMrms
Analog Referred Noise	Vn	0.00	LSBrms
Total Harmonic Distortion	THD	0.0200	%
Total Harmonic Distortion	THD	-74.0	dB

Consistent

**We find SINAD = 68.8dB
It meets our target with
a 8.8dB margin.**

Selecting the Best Data Converter for Your Noise Budget

Step 7: Re-examining the Noise Distribution

Re-examining the worst case noise and distortions levels, we find the quantization noise comprises a smaller proportion of the noise source, but still dominates.

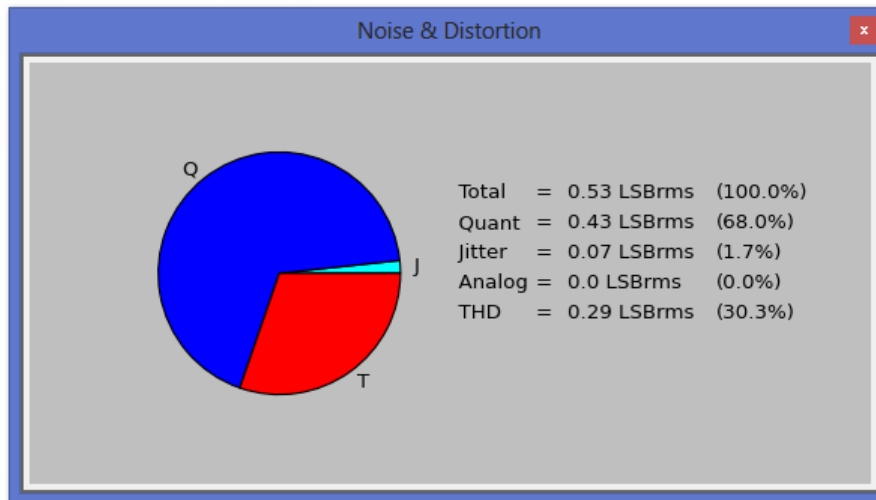

The total noise was reduced by 70%

From $0.44\text{LSB}_{\text{RMS}}$ at 10 bits

To $0.53\text{LSB}_{\text{RMS}}$ at 12 bits (equivalent to $0.13\text{LSB}_{\text{RMS}}$ at 10-bit)

Selecting the Best Data Converter for Your Noise Budget

An example of a higher resolution ADC

MAX1162 - ADC

ELECTRICAL CHARACTERISTICS

(AVDD = DVDD = +4.75V to +5.25V, fSCLK = 4.8MHz (50% duty cycle), 24 clocks/conversion (200ksps), VREF = +4.096V, CREF = 4.7μF, TA = TMIN to TMAX, unless otherwise noted. Typical values are at TA = +25°C.)

PARAMETER	SYMBOL	CONDITIONS		MIN	TYP	MAX	UNITS
DC ACCURACY (NOTE 1)							
Resolution				16			Bits
Relative Accuracy (Note 2)	INL	MAX1162A				±2	LSB
		MAX1162B				±2	
		MAX1162C				±4	
Differential Nonlinearity	DNL	No missing codes over temperature	MAX1162A			±1	LSB
			MAX1162B	-1		±1.75	
		MAX1162C			±2		
Transition Noise		RMS noise			±0.65		LSBRMS
Total Harmonic Distortion	THD					-90	dB
Aperture Jitter	tAJ				<50		ps
Sample Rate	fS	fSCLK / 24				200	ksps

N = 16-bit

DNL = 1.0LSB

Vn = 0.65LSBRMS

THD = -90dB

Tj = 50ps

Selecting the Best Data Converter for Your Noise Budget

Entering Parameter Values

Enter the worst case MAX1162 parameters:

1. N = 16-bit
2. DNL = 1.0LSB
3. Tj = 5PPM
4. Vn = 0.65LSB
5. THD = -90dB

Effective Number of Bits	ENOB	13.8	bit
Signal to Noise and Distortion	SINAD	84.7	dB
Resolution	Res	16.0	bit
Bandwidth	BW	100.0	%Fn
Over Sample Ratio	OSR	1.0	xFs
Differential Non Linearity	DNL	1.00	LSB
Clock Jitter	Tj	5.00	PPMrms
Analog Referred Noise	Vn	0.65	LSBrms
Total Harmonic Distortion	THD	0.0032	%
Total Harmonic Distortion	THD	-90.0	dB

Consistent

We find SINAD is 84.7dB

Selecting the Best Data Converter for Your Noise Budget

Examining the Noise Distribution

Examining the worst case noise and distortion levels, we find an even distribution of noise, where no one source of noise stands out as a major contributor.

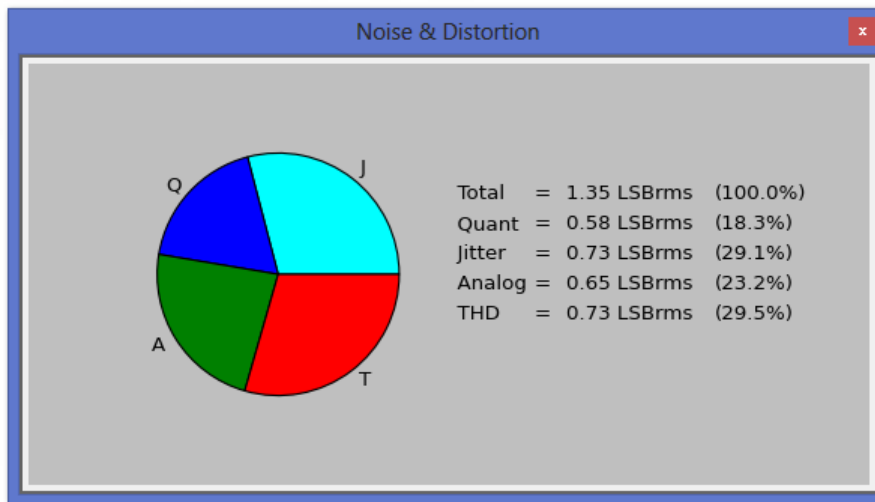

We see that at 14 to 16 bits, jitter and analog noise become as important as quantization noise and THD.

Selecting the Best Data Converter for Your Noise Budget

Step 8: Making Noise Distribution Trade-offs

The calculator can plot any parameter with respect to another. Trade-offs can be made between noise sources that will result in the SINAD.

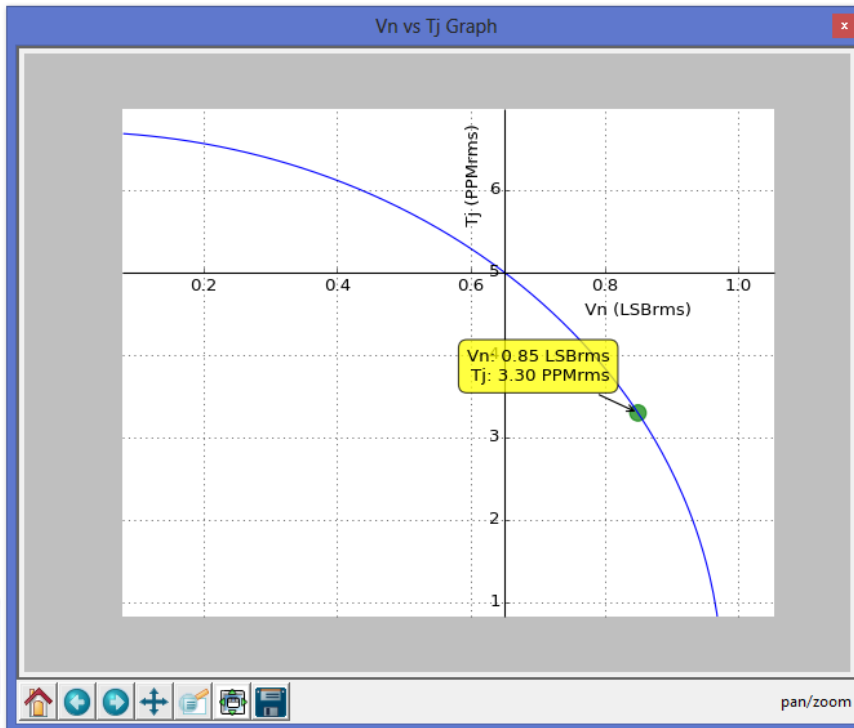

- The cursor position indicates a trade-off between V_n and T_j that maintains a SINAD of 84.7dB.
- The cursor position indicates that if T_j can be decreased to 3.30PPM then the input noise can be increased to 0.85LSB and maintain the same SINAD of 84.7dB.

Understanding Noise in the Signal Chain Summary

- **The origin and characteristics of the noise sources**
 - Thermal noise
 - Shot noise
 - Avalanche noise
 - Flicker noise
 - Popcorn noise
- **A tool for predicting noise amplitude over any bandwidth**
- **The origin and characteristics of data converter noise sources**
 - Quantization noise
 - Aperture jitter
 - Harmonic distortion
 - Analog referred noise
- **A tool for selecting the best data converter for a given noise**

Understanding Noise in the Signal Chain

Discovery Questions

- **Is there a data converter in your signal chain? If so, what is the resolution?**
- **What is the sample rate?**
 - High frequency: Communications, wideband noise and distortion are most important
 - Low frequency: Measurement and control, flicker noise and DC accuracy are most important
- **What are the noise requirements? V_{rms} , V_{pp} , SNR, SINAD, ENOB?**
- **What is the bandwidth of your channel?**

Noise in Semiconductor Devices - Calculators

The Thermal Noise and Effective Number of Bits (ENOB) calculators can be downloaded from Intersil's website using the following URL: www.intersil.com/noise-calculators



ENOB Calc.exe



TNC Calc.exe

intersilTM

www.intersil.com

The bottom of the page features decorative wavy lines in shades of light green and blue, creating a sense of motion and depth.