

REVISIONS			
REV	DESCRIPTION	DATE	APPROVED
00	INITIAL RELEASE	7/7/10	R.T
01	COMBINE POD & LAND PATTERN	7/9/13	KS

EVEN LEAD SIDES

ODD LEAD SIDES

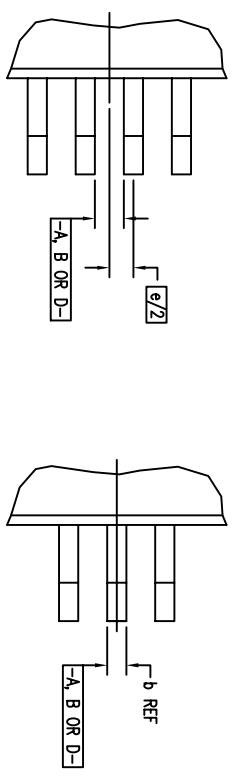

DETAIL A

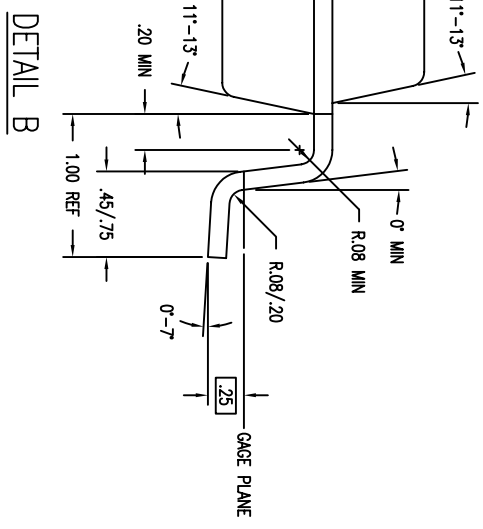
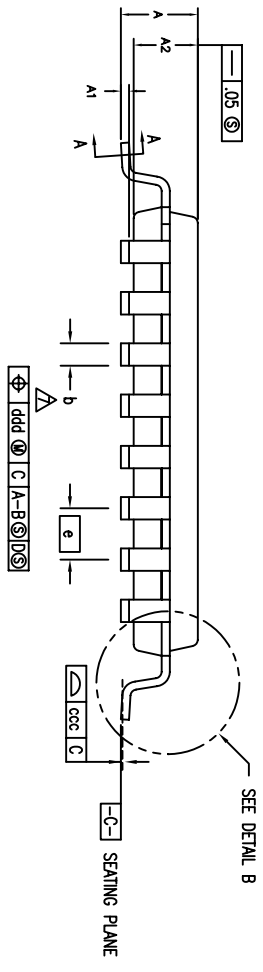
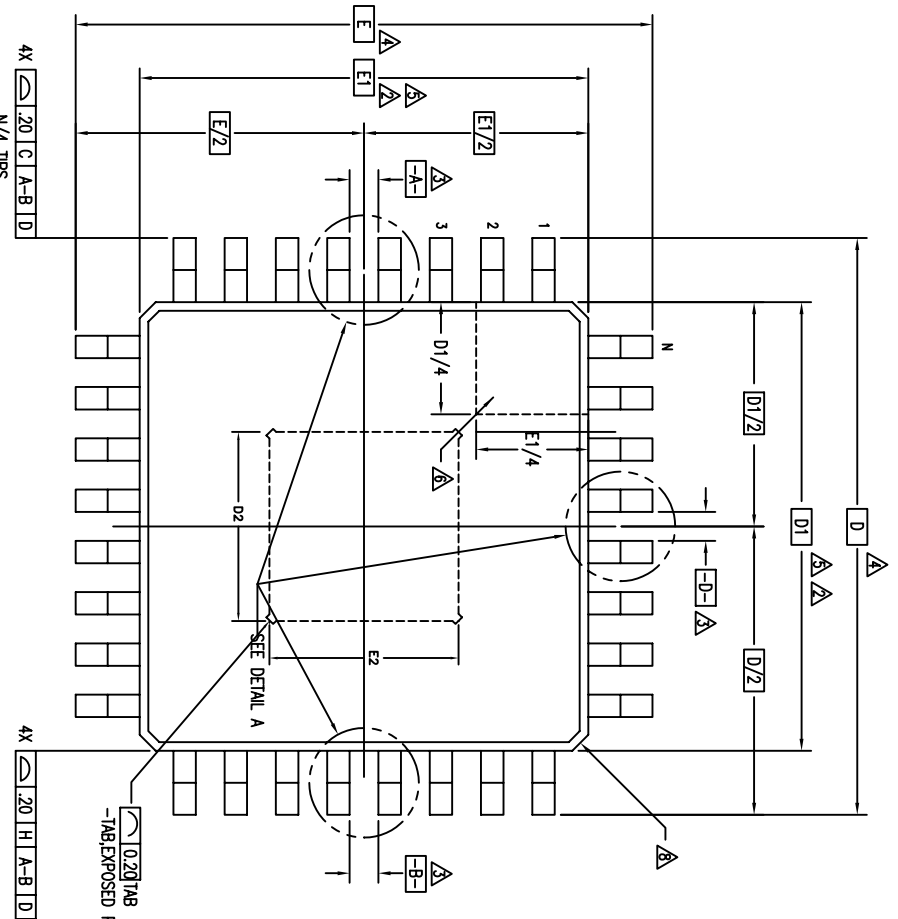

DETAIL B

SECTION A-A

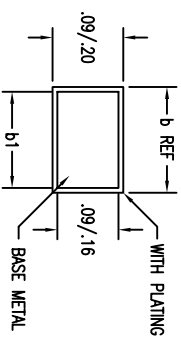

TOLERANCES UNLESS SPECIFIED		 8024 Silver Creek Valley Rd San Jose, CA 95138 PHONE: (408) 284-8200 FAX: (408) 284-3572
DECIMAL	±	
ANGULAR	±	
XXX±		
APPROVALS	DATE	TITLE
DRAWN	02/07/77/10	DX/DXG32 PACKAGE OUTLINE
CHECKED		7.0 X 7.0 X 1.0 mm TOPP
		1.00/.10 FORM
SIZE	DRAWING NO.	REV
C	PSC-4318	01
DO NOT SCALE DRAWING		
SHEET 1 OF 3		

REVISIONS			
REV	DESCRIPTION	DATE	APPROVED
00	INITIAL RELEASE	7/7/10	R.T
01	COMBINE POD & LAND PATTERN	7/9/13	KS

SYMBOL	JEDEC VARIATION			NOTE
	MIN	NOM	MAX	
A	-	-	1.20	
A1	.05	.10	.15	
A2	0.95	1.00	1.05	
D		9.00 BSC		4
D1		7.00 BSC		5,2
E		9.00 BSC		4
E1		7.00 BSC		5,2
N		.32		
e		.80 BSC		
E2		3.5		
D2		3.5		
b	.30	.37	.45	7
b1	.30	.35	.40	
ccc	-	-	.10	
ddd	-	-	.20	

NOTES:

- 1 ALL DIMENSIONING AND TOLERANCING CONFORM TO ANSI Y14.5M-1982
- TOP PACKAGE MAY BE SMALLER THAN BOTTOM PACKAGE BY .15 mm
- ▲ DATUMS [A-B] AND [-D-] TO BE DETERMINED AT DATUM PLANE [-H-]
- ▲ DIMENSIONS D AND E ARE TO BE DETERMINED AT SEATING PLANE [-C-]
- ▲ DIMENSIONS D1 AND E1 DO NOT INCLUDE MOLD PROTRUSION. ALLOWABLE MOLD PROTRUSION IS .25 mm PER SIDE. D1 AND E1 ARE MAXIMUM BODY SIZE DIMENSIONS INCLUDING MOLD MISMATCH
- ▲ DETAILS OF PIN 1 IDENTIFIER IS OPTIONAL BUT MUST BE LOCATED WITHIN THE ZONE INDICATED
- ▲ DIMENSION b DOES NOT INCLUDE DAMBAR PROTRUSION. ALLOWABLE DAMBAR PROTRUSION IS .08 mm IN EXCESS OF THE b DIMENSION AT MAXIMUM MATERIAL CONDITION. DAMBAR CANNOT BE LOCATED ON THE LOWER RADIUS OR THE FOOT.
- ▲ EXACT SHAPE OF EACH CORNER IS OPTIONAL
- ▲ THESE DIMENSIONS APPLY TO THE FLAT SECTION OF THE LEAD BETWEEN .10 AND .25 mm FROM THE LEAD TIP
- 10 ALL DIMENSIONS ARE IN MILLIMETERS
- 11 THIS OUTLINE CONFORMS TO JEDEC PUBLICATION 95 REGISTRATION MS-026, VARIATIONS BBA & BBC.

TOLERANCES UNLESS SPECIFIED		ANGULAR	
DECIMAL	±		
XXE			
XXXE			
XXXXE			
APPROVALS	DATE	TITLE	
DRAWN	08/07/7/10	DX/DXG32 PACKAGE OUTLINE	
CHECKED		7.0 X 7.0 X 1.0 mm TQFP	
		1.00/.10 FORM	
SIZE		DRAWING No.	REV
C		PSC-4318	01
DO NOT SCALE DRAWING			
		SHEET 2 OF 3	

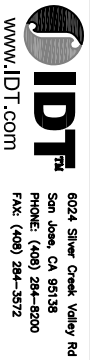

REVISIONS			
REV	DESCRIPTION	DATE	APPROVED
00	INITIAL RELEASE	7/7/10	R.T
01	COMBINE POD & LAND PATTERN	7/9/13	KS

LAND PATTERN DIMENSIONS

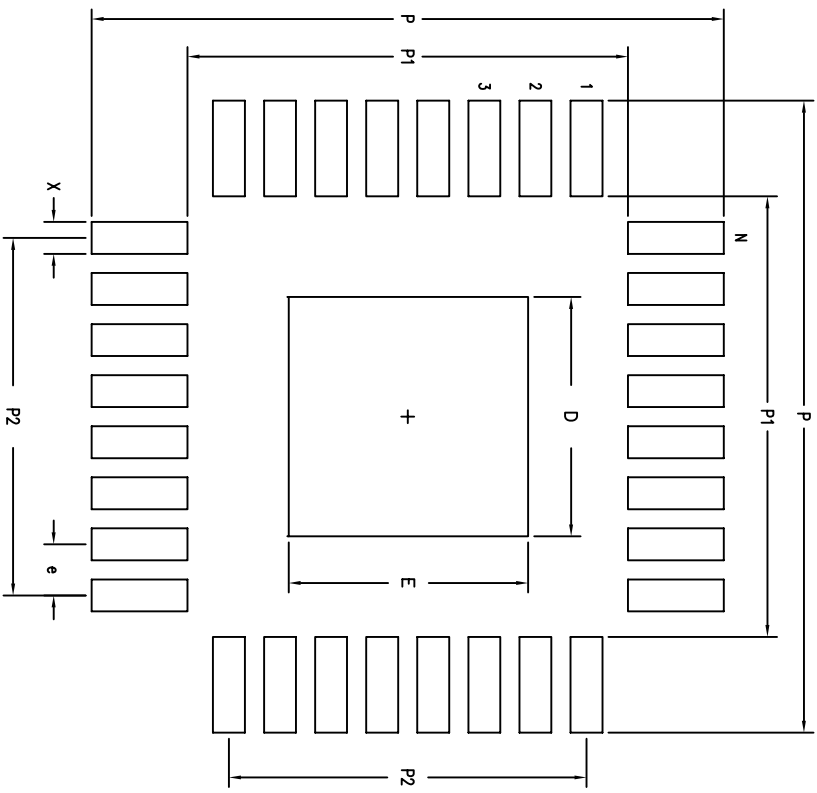

	UNIT (MM)
P	9.90
P1	6.90
P2	5.60
X	.45
e	.80
D	3.80
E	3.80
N	32

TOLERANCES UNLESS SPECIFIED		 6024 Silver Creek Valley Rd San Jose, CA 95138 PHONE: (408) 284-8200 FAX: (408) 284-3572
DECIMAL	±	
ANGULAR	±	
XXX±		
APPROVALS	DATE	TITLE
XXXX	09/04/08	DX/DXG32 PACKAGE OUTLINE
DRAWN		7.0 X 7.0 X 1.4 mm TOPP
CHECKED		1.00/.10 FORM
SIZE		REV
C		01
DO NOT SCALE DRAWING		SHEET 3 OF 3