

14-PIN PLASTIC SDIP (7.62mm(300))

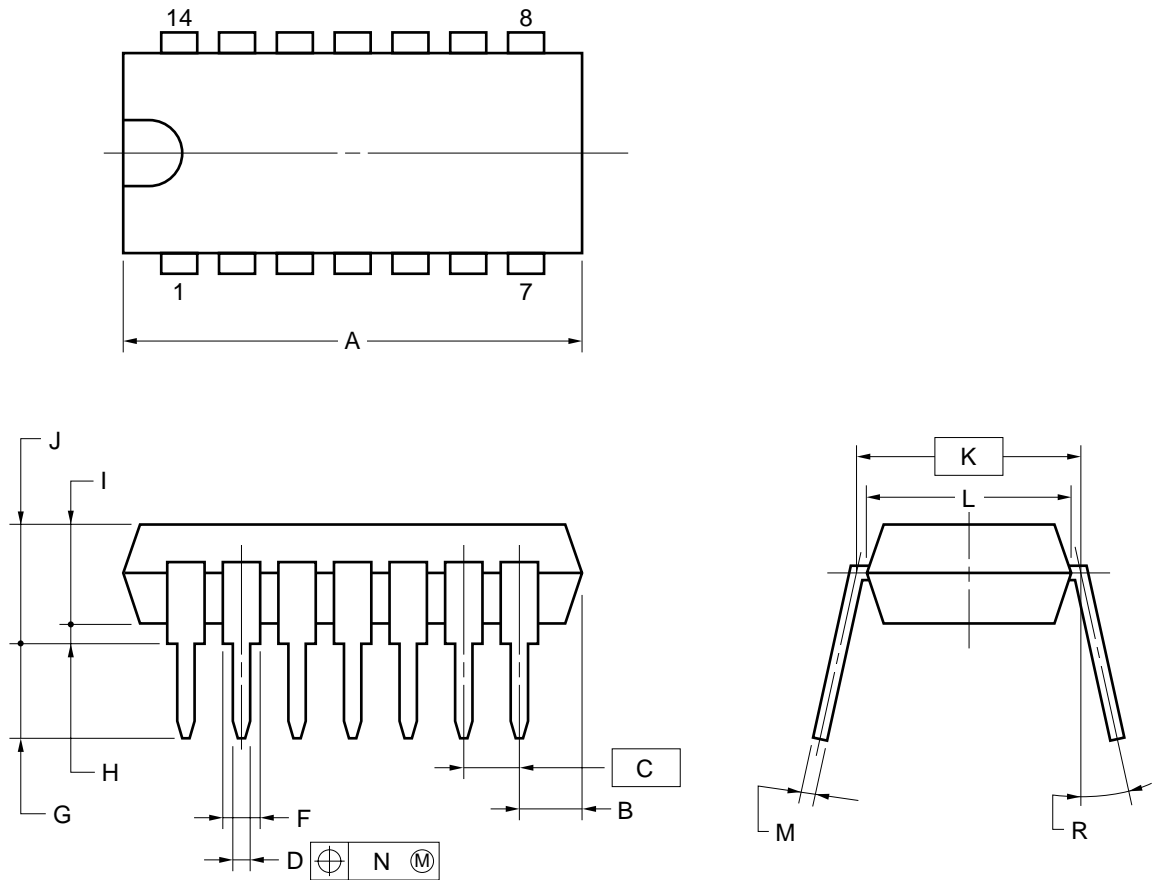

NOTES

- Each lead centerline is located within 0.17 mm of its true position (T.P.) at maximum material condition.
- Item "K" to center of leads when formed parallel.

ITEM	MILLIMETERS
A	16.01 MAX.
B	2.67 MAX.
C	1.778 (T.P.)
D	0.50±0.10
F	0.85 MIN.
G	3.2±0.3
H	0.51 MIN.
I	4.31 MAX.
J	5.08 MAX.
K	7.62 (T.P.)
L	6.5
M	0.25 ^{+0.10} _{-0.05}
N	0.17
R	0~15°

P14C-70-300B-2