

26-PIN PLASTIC SOJ (7.62mm(300))

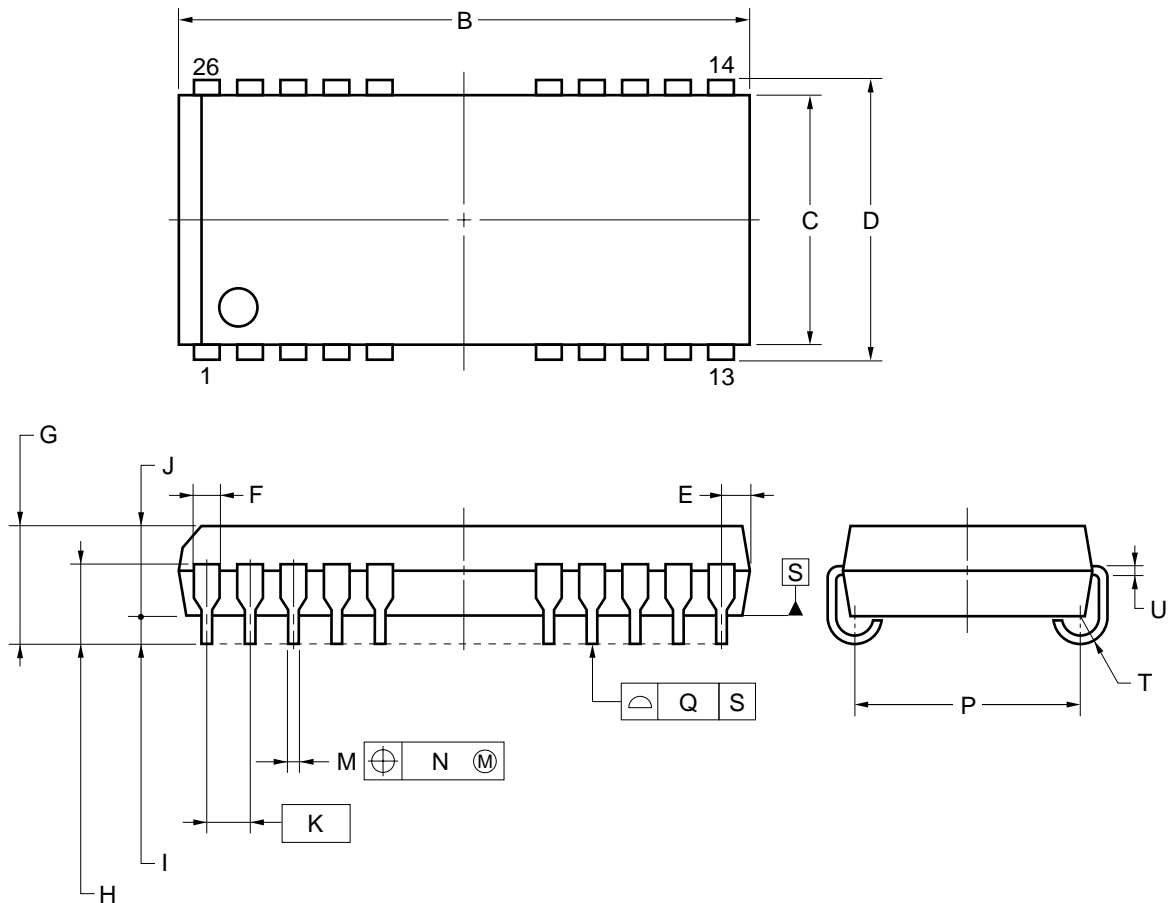

NOTE

Each lead centerline is located within 0.12 mm of its true position (T.P.) at maximum material condition.

ITEM	MILLIMETERS
B	$17.4^{+0.2}_{-0.35}$
C	7.57
D	8.47 ± 0.2
E	1.08 ± 0.15
F	0.6
G	3.5 ± 0.2
H	2.4 ± 0.2
I	0.8 MIN.
J	2.6
K	1.27(T.P.)
M	0.40 ± 0.10
N	0.12
P	6.73 ± 0.20
Q	0.15
T	R 0.85
U	$0.20^{+0.10}_{-0.05}$

P26LA-50A-3