

Top View

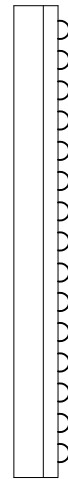

Side View

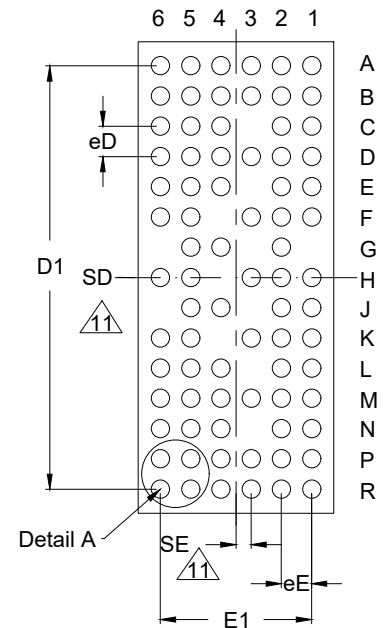

Bottom View

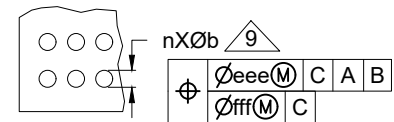
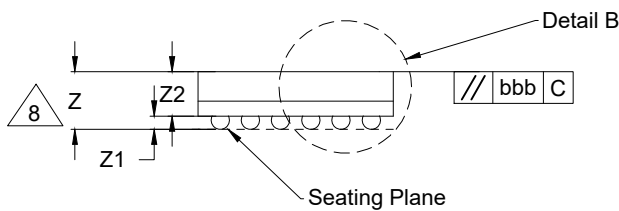

Detail A

TABLE 1

COMMON DIMENSIONS				
SYMBOLS†	MIN	NOM	MAX	NOTES
b	0.25	0.30	0.35	9
b1	0.20	0.25	0.30	15
eD	0.50 BSC			
eE	0.50 BSC			
NOTES	1, 2			

TABLE 2

TOLERANCES OF FORM AND POSITION	
SYMBOLS	TOLERANCE
aaa	0.15
bbb	0.20
ddd	0.08
eee	0.15
fff	0.05
NOTES	1, 2

TABLE 3

VARIATION TABLE		
VARIATION SYMBOLS	AN	NOTES
Z	MIN	0.800
	NOM	-
	MAX	1.000
Z1	MIN	0.15
	NOM	-
	MAX	-
Z2	MIN	-
	NOM	-
	MAX	0.85
D BSC	7.80	
D1 BSC	7.00	
E BSC	3.23	
E1 BSC	2.50	
MD	15	4, 12
ME	6	4, 12
n	78	5, 12
SD	0.00	11
SE	0.25	11
NOTE	1, 2	

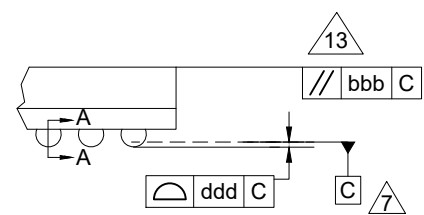

Detail B

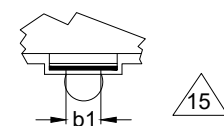

Section A-A

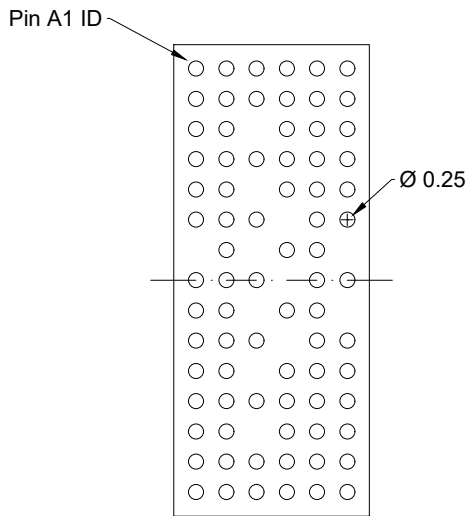

Recommended Land Pattern

NOTES

1. All dimensions are in mm, Angles in degrees.
2. Top down view, as view on PCB.
3. NSMD Land Pattern Assumed.
4. Land Pattern Recommendation as per IPC-7351B generic requirement for surface mount design and Land Pattern.

NOTES

1. DIMENSIONING AND TOLERANCING PER ASME Y14.5M-1994. THIS OUTLINE CONFORMS TO JEP95, SECTION 4.6.
2. DIMENSIONS ARE IN MILLIMETERS.
3. BALL DESIGNATIONS PER JEP95, SECTION 3, SPP-020.
4. MD AND ME REPRESENT THE MAXIMUM MATRIX SIZE CORRESPONDING TO THE D AND E DIRECTIONS, RESPECTIVELY.
5. n REPRESENTS THE NUMBER OF BALLS POPULATED ON THE BOTTOM SIDE FOR EACH VARIATION.
6. A 14X14 PERIPHERAL MATRIX IS SHOWN FOR ILLUSTRATION ONLY.
7. DATUM C (SEATING PLANE) IS DEFINED BY THE CROWNS OF THE BALLS.
8. PACKAGE PROFILE HEIGHT (Z) INCLUDES STAND-OFF HEIGHT (Z1) AND BODY THICKNESS (Z2).
9. DIMENSION b IS MEASURED AT THE MAXIMUM BALL DIAMETER IN A PLANE PARALLEL TO DATUM C.
10. THE CORNER A1 MUST BE IDENTIFIED ON BOTH THE BOTTOM AND TOP SIDES OF THE PACKAGE. THE IDENTIFICATION FEATURE CAN BE MADE USING INK OR METALIZED MARKINGS, INDENTATIONS, OR OTHER FEATURES. THE EXACT SHAPE OF EACH CORNER IS OPTIONAL.
11. DIMENSIONS SD AND SE ARE MEASURED WITH RESPECT TO DATUMS A AND B AND DEFINE THE POSITION OF THE CENTER MOST BALLS IN THE OUTER ROW FOR A FULLY POPULATED MD X ME. WHEN THERE IS AN ODD NUMBER OF BALLS IN THE OUTER ROW, SD AND SE = 0. WHEN THERE IS AN EVEN NUMBER OF BALLS IN THE OUTER ROW, SD AND SE = e/2.
12. THE BALL ARRAY MAY BE DEPOPULATED IN ANY PATTERN. DEPOPULATION IS THE OMISSION OF BALLS FROM A FULL MD X ME MATRIX.
13. PARALLELISM (bbb) APPLIES ONLY TO THE SURFACE DIRECTLY ABOVE THE DIE AREA FOR GLOB TOP, OVER MOLDED AND / OR FLIP CHIP CONFIGURATIONS. THE PARALLELISM SPECIFICATION WILL NOT APPLY TO ANY FILLET OR SLOPED REGION OF THE ENCAPSULANT.
14. SEE FIGURES 3 FOR ALL BALL DEPOPULATIONS.
15. THE SOLDERABLE SURFACE MAY BE DEFINED BY AN OPENING IN THE SOLDER RESIST LAYER. IT MAY BE ELLIPTICAL, PROVIDED THE RATIO OF MAJOR TO MINOR AXIS IS NO GREATER THAN 2/1, AND THE SURFACE AREA IS NO LESS THAN THE MINIMUM FOR A CIRCULAR PAD.