

DATE CREATED	REVISIONS		
	REV	DESCRIPTION	AUTHOR
03/10/95	01	REDRAW TO JEDEC FORMAT	T. VU
08/15/95	02	ADD 28 LD	T. VU
12/15/99	03	CHANGE TO QSOP	S.SUE
10/08/04	04	ADD "GREEN" PCG NOMENCLATURE	TU VU
11/15/11	05	CHANGE RADIUS DIM	CK LEE
1/13/16	06	ADD mm DIMENSION on TABLE	JH
7/14/17	07	ADD "N" ON TABLE	JH

NOTE: REFER TO DCP FOR OFFICIAL RELEASE DATE

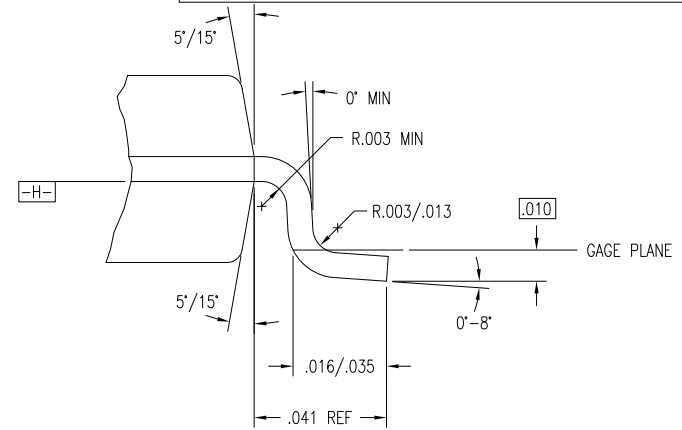

DETAIL B

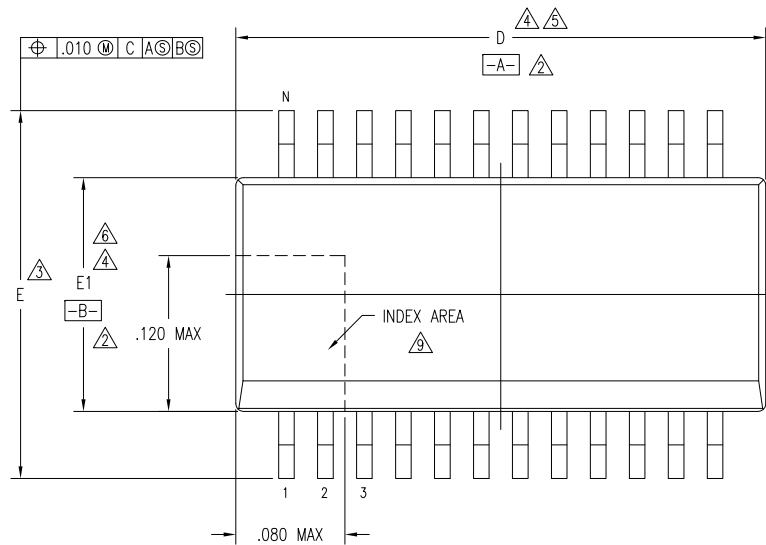
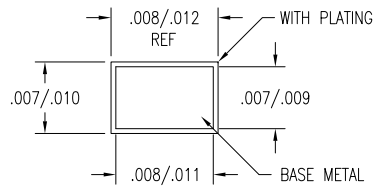
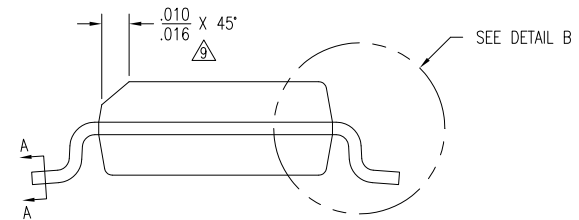
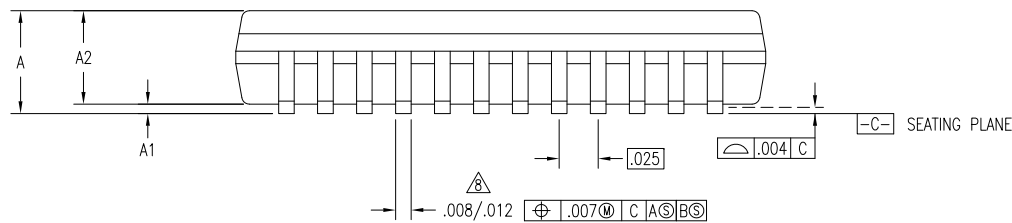

SECTION A-A

TOLERANCES UNLESS SPECIFIED DECIMAL XX± XXX± XXXX±	 <b>www.IDT.com</b>	2975 Stender Way Santa Clara, CA 95054 PHONE: (408) 727-6116 FAX: (408) 492-8674	
		TITLE PC/PCG PACKAGE OUTLINE .150" BODY WIDTH QSOP .025" PITCH	
SIZE <b>C</b>	DRAWING No. PSC-4040	REV 07	
DO NOT SCALE DRAWING		SHEET 1 OF 2	

PACKAGE DIMENSION:

SYMBOL	JEDEC VARIATION																								NOTE
	AB (INCHES)			AB (mm)			AD (INCHES)			AD (mm)			AE (INCHES)			AE (mm)			AF (INCHES)			AF (mm)			
	MIN.	NOM.	MAX.	MIN.	NOM.	MAX.	MIN.	NOM.	MAX.	MIN.	NOM.	MAX.	MIN.	NOM.	MAX.	MIN.	NOM.	MAX.	MIN.	NOM.	MAX.	MIN.	NOM.	MAX.	
A	0.061	0.064	0.068	1.55	1.63	1.73	0.061	0.064	0.068	1.55	1.63	1.73	0.061	0.064	0.068	1.55	1.63	1.73	0.061	0.064	0.068	1.55	1.63	1.73	
A1	0.004	0.006	0.01	0.10	0.15	0.25	0.004	0.006	0.01	0.10	0.15	0.25	0.004	0.006	0.01	0.10	0.15	0.25	0.004	0.006	0.01	0.10	0.15	0.25	
A2	0.055	0.058	0.061	1.40	1.47	1.55	0.055	0.058	0.061	1.40	1.47	1.55	0.055	0.058	0.061	1.40	1.47	1.55	0.055	0.058	0.061	1.40	1.47	1.55	11
D	0.189	0.194	0.196	4.80	4.93	4.98	0.337	0.342	0.344	8.56	8.69	8.74	0.337	0.342	0.344	8.56	8.69	8.74	0.339	0.39	0.394	8.60	9.91	10.01	4,5
E	0.23	0.236	0.244	5.84	5.99	6.20	0.23	0.236	0.244	5.84	5.99	6.20	0.23	0.236	0.244	5.84	5.99	6.20	0.23	0.236	0.244	5.84	5.99	6.20	3
E1	0.15	0.155	0.157	3.81	3.94	3.99	0.15	0.155	0.157	3.81	3.94	3.99	0.15	0.155	0.157	3.81	3.94	3.99	0.15	0.155	0.157	3.81	3.94	3.99	4,6
N	16						20						24						28						

DATE CREATED	REVISIONS		
	REV	DESCRIPTION	AUTHOR
03/10/95	01	REDRAW TO JEDEC FORMAT	T. VU
08/15/95	02	ADD 28 LD	T. VU
12/15/99	03	CHANGE TO QSOP	S.SUE
10/08/04	04	ADD "GREEN" PCG NOMENCLATURE	TU VU
11/15/11	05	CHANGE RADIUS DIM	CK LEE
1/13/16	06	ADD mm DIMENSION on TABLE	JH
7/14/17	07	ADD "N" ON TABLE	JH

NOTE: REFER TO DCP FOR OFFICIAL RELEASE DATE

LAND PATTERN DIMENSIONS

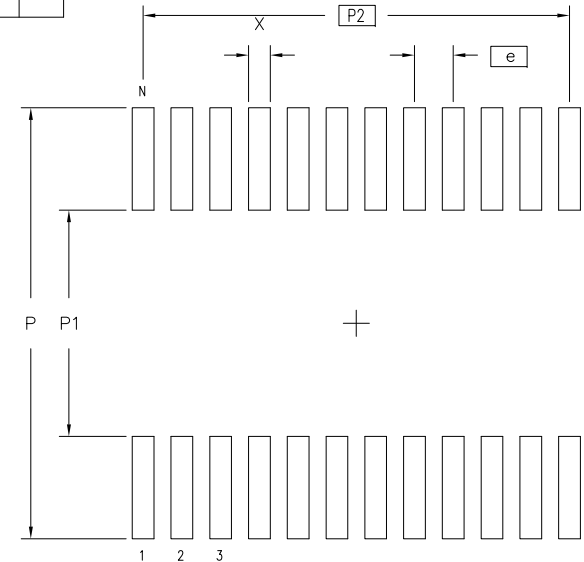

NOTES:

- 1 ALL DIMENSIONING AND TOLERANCING CONFORM TO ANSI Y14.5M-1982
- ② DATUMS [-A-] AND [-B-] TO BE DETERMINED AT DATUM PLANE [-H-]
- ③ DIMENSION E TO BE DETERMINED AT SEATING PLANE [-C-]
- ④ DIMENSIONS D AND E1 ARE TO BE DETERMINED AT DATUM PLANE [-H-]
- ⑤ DIMENSION D DOES NOT INCLUDE MOLD FLASH, PROTRUSIONS OR GATE BURRS. MOLD FLASH, PROTRUSIONS AND GATE BURRS SHALL NOT EXCEED .006 PER SIDE
- ⑥ DIMENSION E1 DOES NOT INCLUDE INTERLEAD FLASH OR PROTRUSIONS. INTERLEAD FLASH OR PROTRUSIONS SHALL NOT EXCEED .010 PER SIDE
- ⑦ THESE DIMENSIONS APPLY TO THE FLAT SECTION OF THE LEAD BETWEEN .005 AND .010 FROM LEAD TIP
- ⑧ LEAD WIDTH DIMENSION DOES NOT INCLUDE DAMBAR PROTRUSION. ALLOWABLE DAMBAR PROTRUSION IS .004 IN EXCESS OF THE LEAD WIDTH DIMENSION AT MAXIMUM MATERIAL CONDITION. DAMBAR CANNOT BE LOCATED ON THE LOWER RADIUS OR THE FOOT
- ⑨ THE CHAMFER ON THE PACKAGE BODY IS OPTIONAL. IF IT IS NOT PRESENT, A VISUAL INDEX FEATURE MUST BE LOCATED WITHIN THE ZONE INDICATED
- 10 ALL DIMENSIONS ARE IN INCHES
- 11 THIS OUTLINE CONFORMS TO JEDEC PUBLICATION 95 REGISTRATION MO-137, VARIATION AB, AD, AE & AF. EXCEPTIONS: JEDEC DIMENSION A2 MAX IS .059

LAND PATTERN DIMENSION:

	INCHES		mm		INCHES		mm		INCHES		mm		INCHES		mm	
	MIN.	MAX	MIN.	MAX	MIN.	MAX	MIN.	MAX	MIN.	MAX	MIN.	MAX	MIN.	MAX	MIN.	MAX
P	0.274	0.282	6.96	7.16	0.274	0.282	6.96	7.16	0.274	0.282	6.96	7.16	0.274	0.282	6.96	7.16
P1	0.142	0.150	3.61	3.81	0.142	0.150	3.61	3.81	0.142	0.150	3.61	3.81	0.142	0.150	3.61	3.81
P2	0.175	BSC	4.45	BSC	0.225	BSC	5.71	BSC	0.275	BSC	6.99	BSC	0.325	BSC	8.25	BSC
X	0.010	0.018	0.254	0.457	0.010	0.018	0.254	0.457	0.010	0.018	0.254	0.457	0.010	0.018	0.254	0.457
e	0.025	BSC	0.635	BSC	0.025	BSC	0.635	BSC	0.025	BSC	0.635	BSC	0.025	BSC	0.635	BSC
N	16				20				24				28			

TOLERANCES UNLESS SPECIFIED  
 DECIMAL ANGULAR  
 XX± ±  
 XXX± ±  
 XXXX± ±



2975 Stender Way  
 Santa Clara, CA 95054  
 PHONE: (408) 727-6116  
 FAX: (408) 492-8674

TITLE PC/PCG PACKAGE OUTLINE  
 .150" BODY WIDTH QSOP  
 .025" PITCH

SIZE C DRAWING No. PSC-4040 REV 07

DO NOT SCALE DRAWING SHEET 2 OF 2