

RZ/T2M Group, RZ/T2L Group, RZ/N2L Group

CN032 AC Servo Solution Startup Guide (for Motion Control Utility)

Introduction

This startup guide is a quick start guide for CN032 AC Servo Solution Kit by using “Motion Control Utility Tool”.

<<Caution when handling the solution board>>

Don't touch the board while power is supplied because CN032 AC servo solution board contains high voltage circuits.

Target Device

RZ/T2M Group

RZ/T2L Group

RZ/N2L Group

When applying the sample program covered in this startup guide to another microcomputer, modify the program according to the specifications for the target microcomputer and conduct an extensive evaluation of the modified program.

Related Document

- CN032 AC Servo Solution Hardware Manual (for RZ/T2M, RZ/N2L)
- CN032 AC Servo Solution Controller Board Manual (for RZ/T2L)
- CN032 AC Servo Solution Inverter Board Manual
- CN032 AC Servo Solution Firmware Manual
- CN032 AC Servo Solution Startup Guide (for Motion Utility Control) (this manual)
- CN032 AC Servo Solution Startup Guide (for EtherCAT)

- RZ/T2M Group User's Manual: Hardware
- RZ/T2L Group User's Manual: Hardware
- RZ/N2L Group User's Manual: Hardware

Contents

1. Overview4

1.1 CN032 AC Servo Solution Overview 4

1.2 Connection Configuration 4

1.3 Connection Equipment 5

1.3.1 220V AC Servo motor 5

1.3.2 Absolute Encoder 5

1.3.3 Communication with the PC 6

1.3.3.1 RS232 to USB 6

1.3.3.2 RS485 to USB 6

1.3.3.3 Selection for RS232 or RS485 6

1.3.4 ICE 7

1.3.5 Power Supply 8

2. Operating Environment9

3. Board Setting 11

3.1 Switches 11

3.1.1 Controller board 11

3.2 Jumpers 11

3.2.1 Controller board 11

4. CN032 AC Servo Solution Execution procedure 12

4.1 Precaution before operation 12

4.2 AC Servo Solution Starting 12

4.3 Motion Control Utility Execution 14

4.3.1 Installation 14

4.3.2 Demonstration Mode 14

4.3.2.1 Motor Parameter Setting 14

4.3.2.2 Starting the CN032 Motion Utility.exe 14

4.3.2.3 Demonstrations Mode 15

4.3.3 Tuner/Analyze Mode 20

4.3.3.1 CN032 Motion Utility.exe Starting 20

4.3.3.2 Position Control Execution 21

4.4 Tuner/Analyzer Mode Specification 23

4.4.1 Menu 24

4.4.1.1 File 24

4.4.1.2 Connect/Disconnect 24

4.4.1.3 View 25

4.4.1.4 Help 26

4.4.2 Main Screen 27

4.4.3 Control Panel 29

4.4.3.1	Setup Tab	29
4.4.3.2	Tuning Tab	33
4.4.3.3	Motion Tab	35
4.4.3.4	Encoder Tab	39
4.4.3.5	Limits tab	40
4.4.4	Motion Scope	43
4.4.5	Terminal	45
5.	Variables	46
6.	Motor Parameters	47
7.	Appendix	49
7.1	Package Folder Structure	49
7.2	How to Install Development Environments	50
7.2.1	Development Environments Install	50
7.2.2	Toolchain Install	51
7.3	Program Writing Procedure	56
7.3.1	Power Supply	56
7.3.2	EWARM	56
7.3.3	e2studio	58
	Revision History	61

1. Overview

1.1 CN032 AC Servo Solution Overview

This application note is implemented by using the Controller board equipped with Renesas Electronics RZ/T2M, RZ/T2L or RZ/N2L and the Inverter board for 220V AC servo motor.

This solution includes software that runs on the Controller board, PC software, and circuit diagram. Therefore, initial evaluation and advance development of industrial motor equipment development using RZ/T2M, RZ/T2L or RZ/N2L can be easily done.

1.2 Connection Configuration

Figure 1-1 is shown the connection configuration.

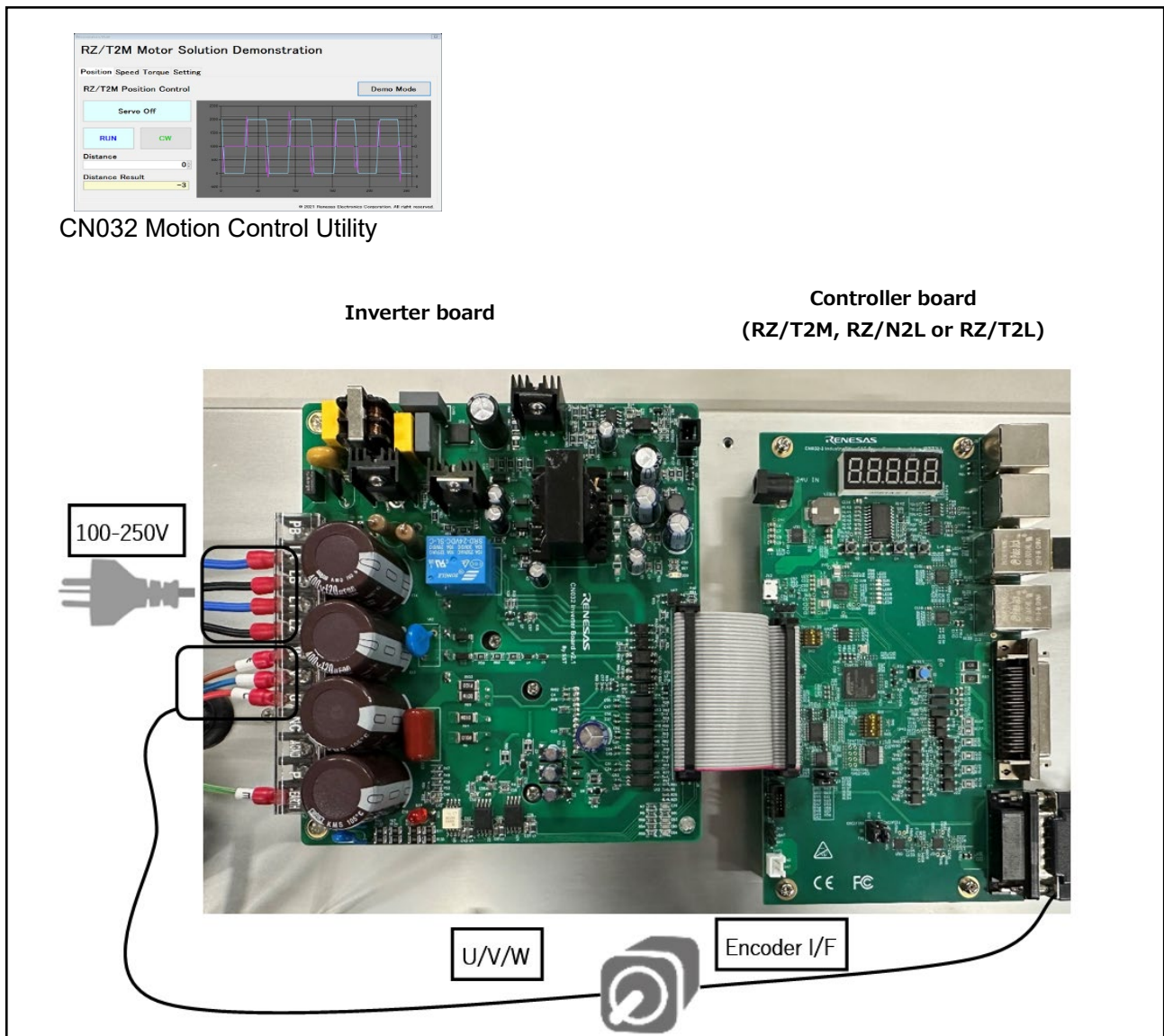

Figure 1-1 Connection Configuration

1.3 Connection Equipment

Table 1-1 is shown the connection equipment list.

Table 1-1 Connection Equipment List

No.	Item	Model	Spec.
1	220V AC Servo motor	BM0602A1PD-A ZhuHai KaiBang Motor Manufacturing Co. , Ltd.	200W, 3000rpm
2	Encoder	TS5669N140 Tamagawa Seiki Co. , Ltd.	17/16Bit
3	Communication with the PC	UART to USB converter	-
4	ICE	- I-jet from IAR Systems - J-Link EDU from Segger	-

1.3.1 220V AC Servo motor



BM0602A1PD-A

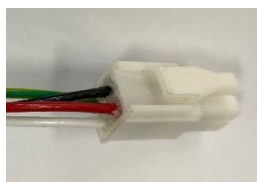

Connector (motor side)



Conversion cable for connecting to Inverter board

Cable Color	Signal
Red	U
Brown	W
Blue	V
Yellow/Green	GND(PE)

1.3.2 Absolute Encoder

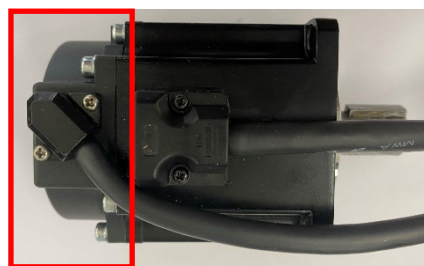

TS5669N140

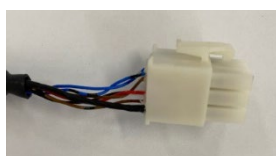

Connector (encoder side)



Conversion cable for connecting to Inverter board

1.3.3 Communication with the PC

1.3.3.1 RS232 to USB

The RS232 to USB Converter is connected to the J5 connector on the controller board. Table 1-2 is shown the connection with controller board.

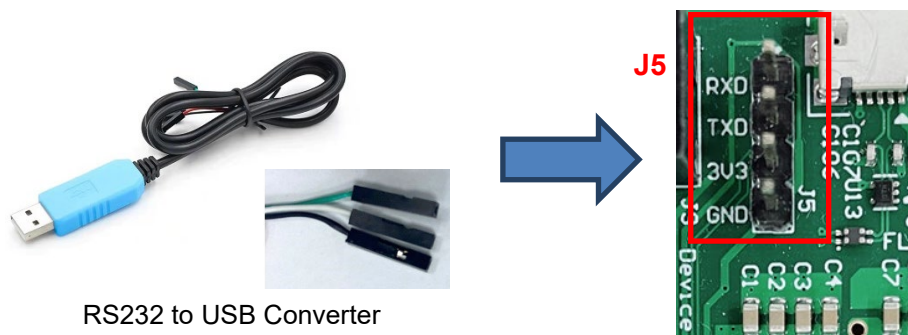

Figure 1-2 Serial connect to host PC

Table 1-2 Connection RS232 to USB Converter with Controller board

RS232 to USB converter	J5	Note
TXD(Green)	RXD(J5-1)	
RXD(White)	TXD(J5-2)	
NC	3V3(J5-3)	Connection is not needed
GND(Black)	GND(J5-4)	

1.3.3.2 RS485 to USB

The RS485 to USB converter is connected the J6 or J8 of the controller board.

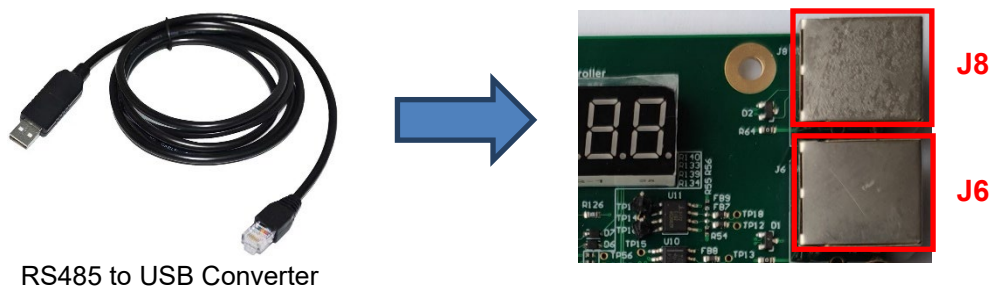

Figure 1-3 Serial connect to host PC

1.3.3.3 Selection for RS232 or RS485

RS232 or RS485 can be selected by SW2-1 according to Table 1-3.

Table 1-3 Communication selection

	RS232	RS485(default)
SW2-1	ON	OFF



SW2 on the board

1.3.5 Power Supply

Supply 100-250V AC power to Inverter board, and supply 5V from Inverter board to Controller board by cable.

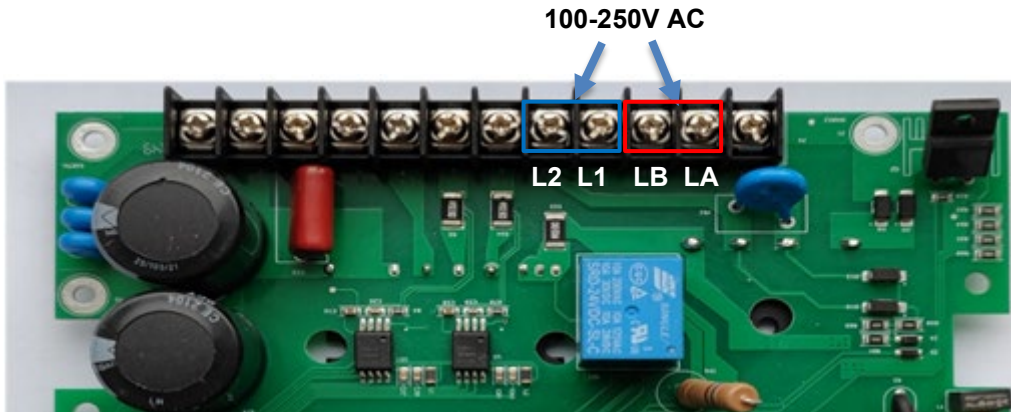

Figure 1-5 Inverter board for 220V Motor

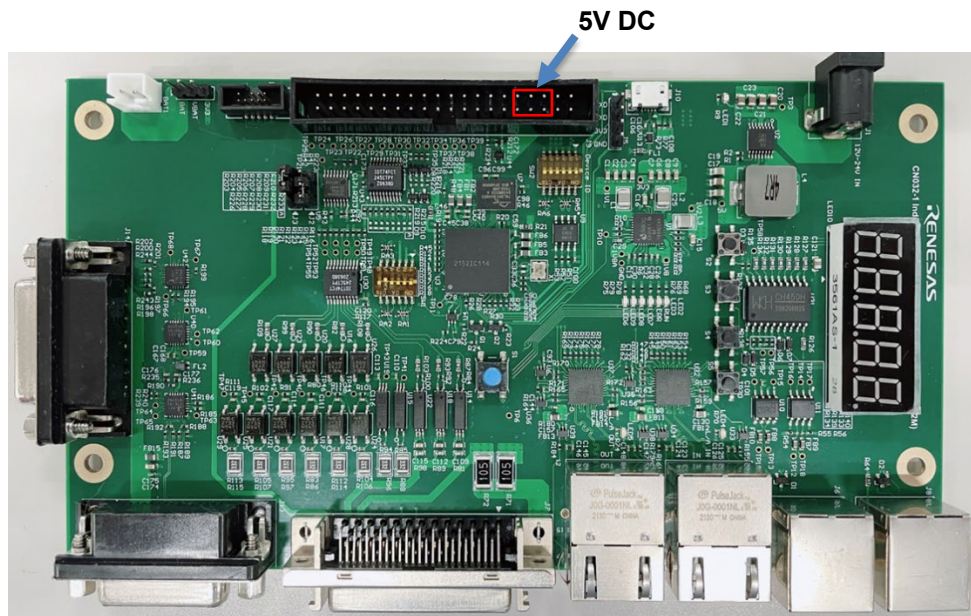

Figure 1-6 Controller board

2. Operating Environment

This solution kit is for the environment below.

From this chapter onwards, the procedure for operating the 220V AC servo motor control system with 220V AC power supply is described.

Table 2-1 Operating Environment

Item		Description		
		RZ/T2M edition	RZ/T2L edition	RZ/N2L edition
MPU	Series	RZ/T2M Dual Arm Cortex®-R52	RZ/T2L Single Arm Cortex®-R52	RZ/N2L Single Arm Cortex®-R52
	Package	R9A07G075M24: 225-pin FBGA	R9A07G074M08: 196-pin FBGA	R9A07G084M04: 225-pin FBGA
Operating frequency		800MHz	800MHz	400MHz
Operating modes		xSPI0 boot mode (x1 boot Serial flash)		
Operating voltage		3.3V/1.8V/1.1V		
Power source for Inverter board		220V AC, 1.5A max. consumption		
Devices (Functions to be used on the board)		Serial flash memory Manufacturer: Renesas Model: AT25SF128A-SHB-T		
Integrated development environment <u>Refer to Appendix 7.2 on how to install.</u>		IAR Systems Embedded Workbench® for Arm 9.32.2		
		Renesas Electronics e²studio 2023-07 Toolchain GNU ARM Embedded 9.3.1 (*1)		
		Renesas Electronics FSPSC 2023-07 (*2)		
Flexible Support Package (FSP)		RZT FSP v1.3.0		RZN FSP v1.3.0
Emulator		Manufactured by IAR Systems I-jet Manufactured by SEGGER J-Link EDU Ver.11.0		
PC Software		Manufactured by Renesas CN032 Motion Control Utility		

(*1) For instructions on how to install the toolchain, refer to Chapter 7.2.2 Toolchain Install

(*2) FSPSC (FSP Smart Configurator) is a code generation tool for IAR Embedded Workbench.

The Table 2-2 Controller board and inverter board combination shows the combination of the controller board and inverter board. Operation is not guaranteed with any combination other than the following.

Table 2-2 Controller board and inverter board combination

No.	Controller board	Inverter board		
		V1.1	V1.2	V2.1
1	RZ/T2M(v1.1)	Available	Available	N/A
2	RZ/T2L(v1.0)	Available	Available	N/A
3	RZ/T2L(v2.0)	N/A	N/A	Available
4	RZ/N2L(v1.1)	Available	Available	N/A

RZ/T2M Group, RZ/T2L Group, RZ/N2L Group Startup Guide (for Motion Control Utility)

When operating No.1, No.2, and No.4 on firmware Ver.5.10 or later in the Table 2-2, change the mode of P15_1 to “Disable” in Pin Configurations as shown below.

The procedure will be explained using the development environment e²studio as an example.

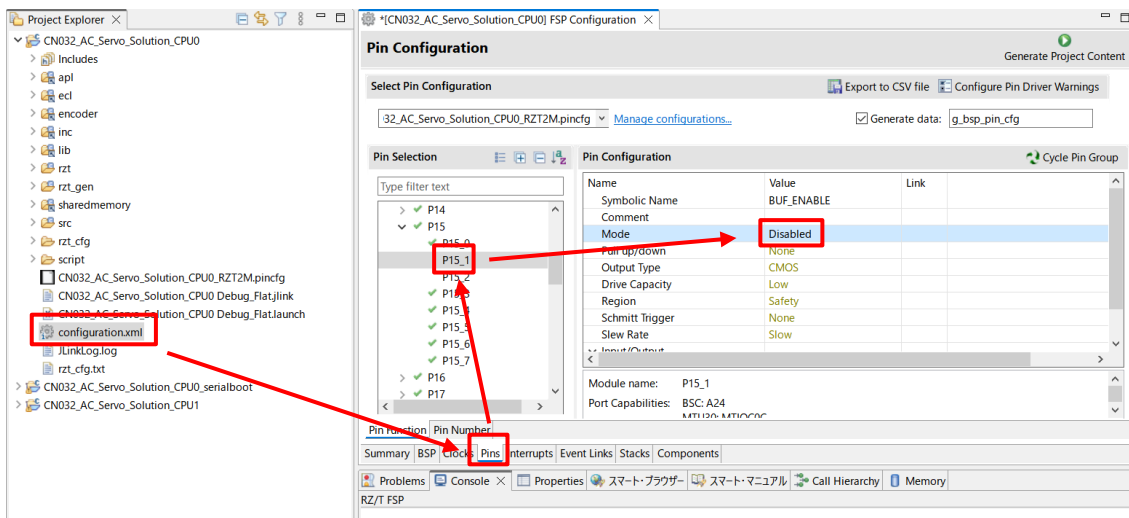

Then click “Generate Project Content” button.

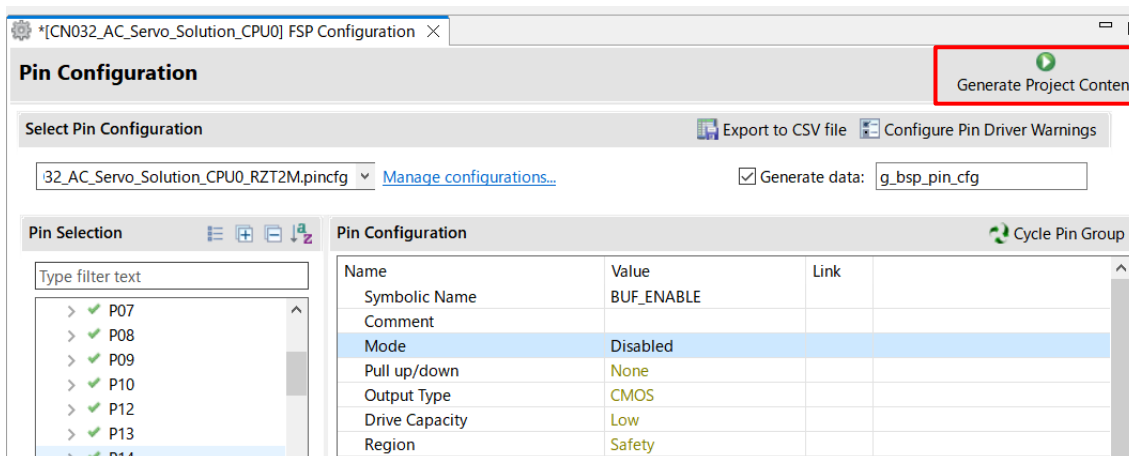

3. Board Setting

3.1 Switches

3.1.1 Controller board

Table 3-1 is shown the switches setting of the Controller board.

Table 3-1 Switches Setting of Controller board

No	SW	Item	Setting	Description	
1	SW1 (Boot mode)	1	MD0	1=ON	xSPI0 boot mode (x1 boot Serial flash)
		2	MD1	2=ON	
		3	MD2	3=ON	
		4	MDD	4=ON	JTAG normal mode
		5	MDW	5=OFF	1 wait
		6	No use	-	-
2	SW2	1	RS485/RS232	1=OFF	OFF: RS485 mode ON: RS232 mode

3.2 Jumpers

3.2.1 Controller board

Table 3-2 is shown the jumpers setting of the Controller board for RZ/T2M, RZ/T2L and RZ/N2L.

Table 3-3 is shown the jumpers setting of the Controller board for RZ/T2L.

Table 3-2 Jumpers Setting of Controller board for RZ/T2M, RZ/T2L and RZ/N2L

No	JP	Item	Setting	Description
1	J2	PWM signal of V- phase	1-2 short	Select MTU3 output signal
2	J3	PWM signal of W+ phase	2-3 short	Select MTU3 output signal

Table 3-3 Jumpers Setting of Controller board for RZ/T2L

No	JP	Item	Setting	Description
1	J14	RXD1/ENCIFDI1 selection	1-2 short	Select RXD1 signal from encoder
2	J15	TXD1/ENCIFDO1 selection	1-2 short	Select TXD1 signal from encoder

4. CN032 AC Servo Solution Execution procedure

4.1 Precaution before operation

When using this kit, please kindly comply with the following 1 to 3:

1. Use stable power supply with current 1[A] limit setting to inverter board.
2. Do not use DC12-24[V] power supply jack to controller board.
※The power of controller is supplied from the inverter board.
3. Even after turning off, please do not touch the inverter board when high voltage LED(D27) is on which could be about 3 minutes or more.

If motor malfunctions or makes noise during use, please turn off the power to the inverter board immediately.

If this malfunction symptom continues, please contact our sales office or agency.

4.2 AC Servo Solution Starting

- ① Connect 220V AC motor to the Inverter board

	Motor	Inverter Board
Connection	W	P4-6
	V	P4-7
	U	P4-8
	GND(PE)	P4-12

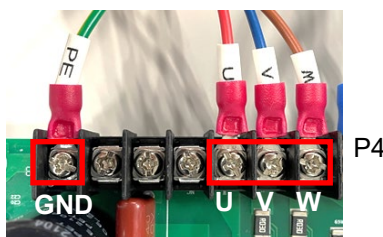

Note: silk for U/W on the inverter board (v1.1 only) is wrong printed.

- ② Connect power supply cable to the Inverter board
LA and L1 of P4 are connected to AC 220V + (blue cable).
LB and L2 of P4 are connected to AC 220V – (black cable).

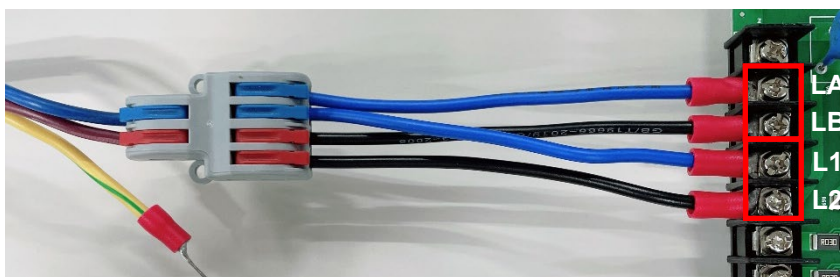

- ③ Connect between the Controller board and the Inverter board
- ④ Connect the encoder to the Controller board
The encoder is connected to the D-Sub15pin connector, and it is connected to the J13 connector of the Controller board.
- ⑤ Connect the J6 or J8 of the Controller board to PC through RS485 to USB converter.
or
Connect the J5 of the Controller board to PC through RS232 to USB converter.

After connecting steps 1 to 5 above, the boards will look like the figure below.

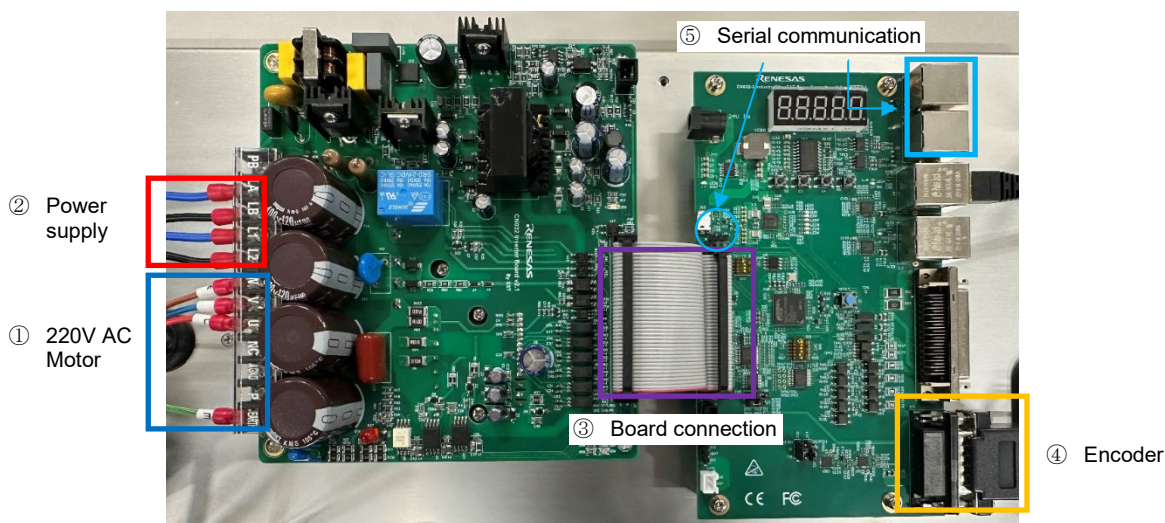

- ⑥ xSPI0 boot mode setting
Set SW1 of the Controller board to the following.



- ⑦ Power supply to the Inverter board, and then the red lamp lights up.
Additionally, the Controller board is supplied 5V DC power from Inverter board and then LED1 lights up.

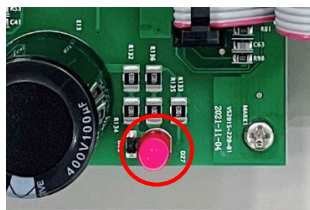

Power lamp of the Inverter board

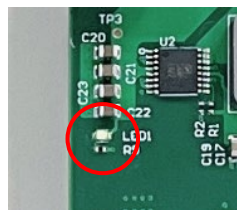

Power LED of the controller board

* : If the program is not stored in the serial Flash ROM, the program is written to the serial Flash ROM. Refer to "7.3 56Program Writing Procedure".

4.3 Motion Control Utility Execution

4.3.1 Installation

Copy the following ZIP file to any folder (*) and unzip the zip file.

CN032_Motion_Utility_For220V.zip

* The Motion Control Utility can be used in the Controller board equipped with RZ/T2M, RZ/T2L or RZ/N2L.

* The folder path name to expand CN032_Motion_Utility_For220V.zip should be alphanumeric characters.

* About ZIP file detail, refer to “7.1 Package Folder Structure”.

4.3.2 Demonstration Mode

4.3.2.1 Motor Parameter Setting

The “default.mtr” is for BM0602A1PD-A motor.

4.3.2.2 Starting the CN032 Motion Utility.exe

■ When RS-232 / RS-485 is connected

Select the COM port number and “Demonstration”. Push the “OK” button.

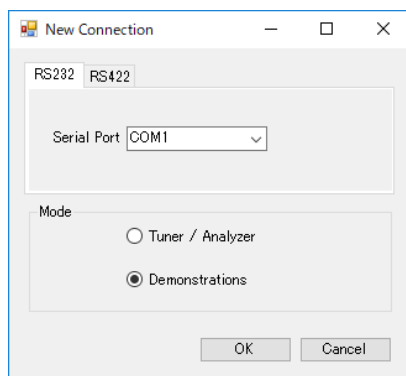

■ RS-422 is not supported

■ Display the connection error

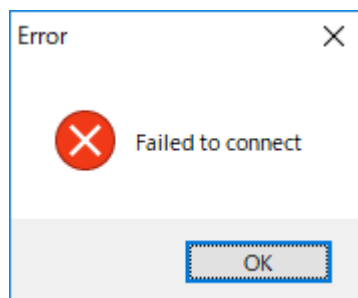

Double-check the CN032 AC Servo Solution connection (refer to “3 Board Setting”), restart the Motion Utility.

4.3.2.3 Demonstrations Mode

In Demonstrations Mode, it is possible to check the operation of speed control/ torque control / position control. To display with PC/tablet, the scaling of various toolboxes is changed according to the screen size. The speed control/torque/position control screen is switched by tab. “Demo Mode” button is had at each control screen and is controlled automatically by pushing this button.

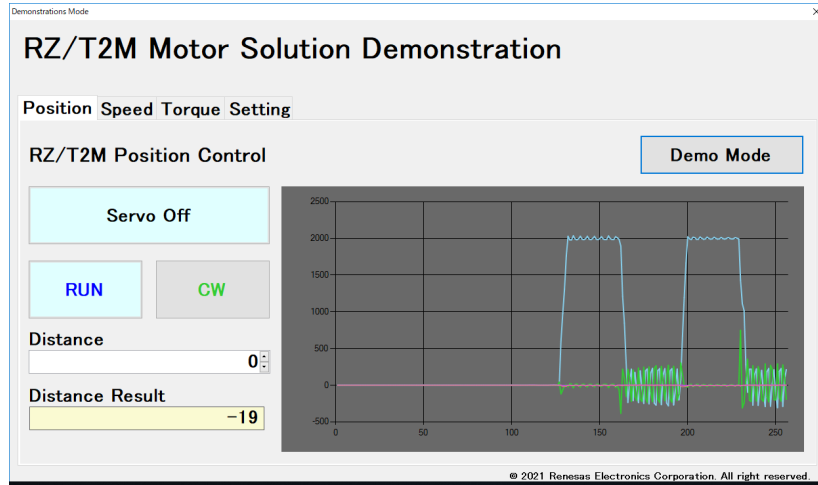

(1) Position Control Screen

Figure 4-1 is shown the Position Control screen.

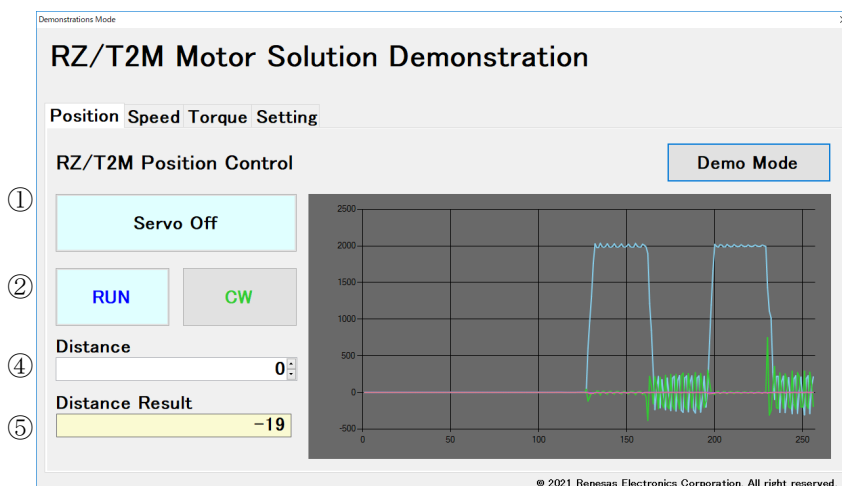

Figure 4-1 Position Control Screen

No.	Item	Description
①	Servo On/Off	This toggle button is controlled the power supply on/off. • When this button is pressed while "Servo On" is displayed, the motor power is turned off. • When this button is pressed while "Servo Off" is displayed, the motor power is turned on
②	RUN/STOP	This toggle button is started/stopped the position control. • When this button is pressed while "RUN" is displayed, the motor rotates to distance(target distance) and stops by applying a torque when reaching the target distance. When stopping, this toggle button is displayed "STOP" -> "RUN". • When this button is pressed while "STOP" is displayed, the motor stops emergency. When stopping, this toggle button is displayed "STOP" -> "RUN".
③	CW/CCW	This toggle button is controlled the direction of motor rotation. • When this button is pressed while "CW" is displayed, the motor rotates forward (clockwise when viewed from the output shaft side). • When this button is pressed while "CCW" is displayed, the motor rotates reverse (counter clockwise when viewed from the output shaft side).
④	Distance	Target distance is set. 0 to 2000 (1 step) can be set. This value cannot be changed while motor rotates.
⑤	Distance Result	The movement distance (result) is displayed at 100ms intervals.
⑥	Demo Mode	This toggle button is operated the Position Control automatically. When this button is pressed while "Demo Mode" is displayed, the following operations are performed. 1. Start the Position Control toward the target position: 20000. 2. After 10 seconds, restart toward the certain target distance: 0. 3. Repeat the above No.1 and No.2. When this button is pressed again, the motor stops. While operating Demo Mode, other buttons (RUN / STOP button, etc.) cannot be used. If other tab (Torque tab/Speed tab) is pressed while operating Demo Mode, Demo Mode is stopped emergency.
⑦	Graph	Waveform of current motor position value (Blue), Pos error (Green) and Id/Iq current value (Red/Orange) are displayed at 100ms intervals as default. The variables and scaling displayed in the graph can be changed. See "5 Variables" for variables.

Note: When using UART to RS232 cable, if there are any noise in the waveform displayed in the graph, please use UAER to RS485 cable.

Speed Control Screen

Figure 4-2 is shown the Speed Control screen.

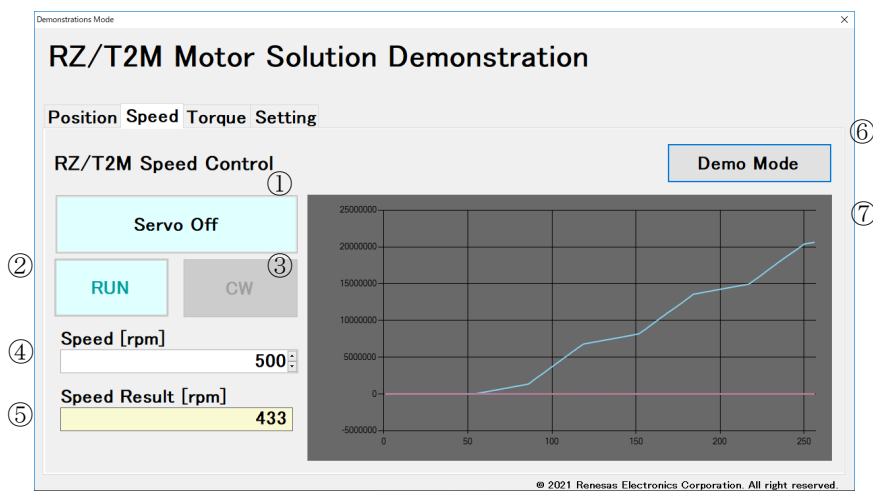

Figure 4-2 Speed Control Screen

No.	Item	Description
①	Servo On/Off	This toggle button is controlled the power supply on/off. • When this button is pressed while "Servo On" is displayed, the motor power is turned on. • When this button is pressed while "Servo Off" is displayed, the motor power is turned off.
②	RUN/STOP	This toggle button is started/stopped the speed control. • When this button is pressed while "RUN" is displayed, the motor rotates at speed[rpm] (target speed). When rotating, this toggle button is displayed "RUN" -> "STOP". • When this button is pressed while "STOP" is displayed, the motor stops emergency. When stopping, this toggle button is displayed "STOP" -> "RUN".
③	CW/CCW	This toggle button is controlled the direction of motor rotation. • When this button is pressed while "CW" is displayed, the motor rotates forward (clockwise when viewed from the output shaft side). • When this button is pressed while "CCW" is displayed, the motor rotates reverse (counter clockwise when viewed from the output shaft side).
④	Speed[rpm]	Target speed is set. 0 to 2000 [rpm] (1 step) can be set. This value can be changed while motor rotates.
⑤	Speed Result[rpm]	The current speed (result) is displayed at 100ms intervals.
⑥	Demo Mode	This toggle button is operated the Speed Control automatically. When this button is pressed while "Demo Mode" is displayed, the following operations are performed. 1. Start the Speed Control at the target speed: 500. 2. After 5 seconds, restart at the certain target speed: 2000. 3. Repeat the above No.1 and No.2. When this button is pressed again, the motor stops. While operating Demo Mode, other buttons (RUN / STOP button, etc.) cannot be used. If other tab (Torque tab/Position tab) is pressed while operating Demo Mode, Demo Mode is stopped emergency.
⑦	Graph	Waveform of current motor position value (Blue), Pos error (Green) and Id/Iq current value (Red/Orange) are displayed at 100ms intervals as default. The variables and scaling displayed in the graph can be changed. See "5 Variables" for variables.

(2) Torque Control Screen

Figure 4-3 is shown the Torque Control screen.

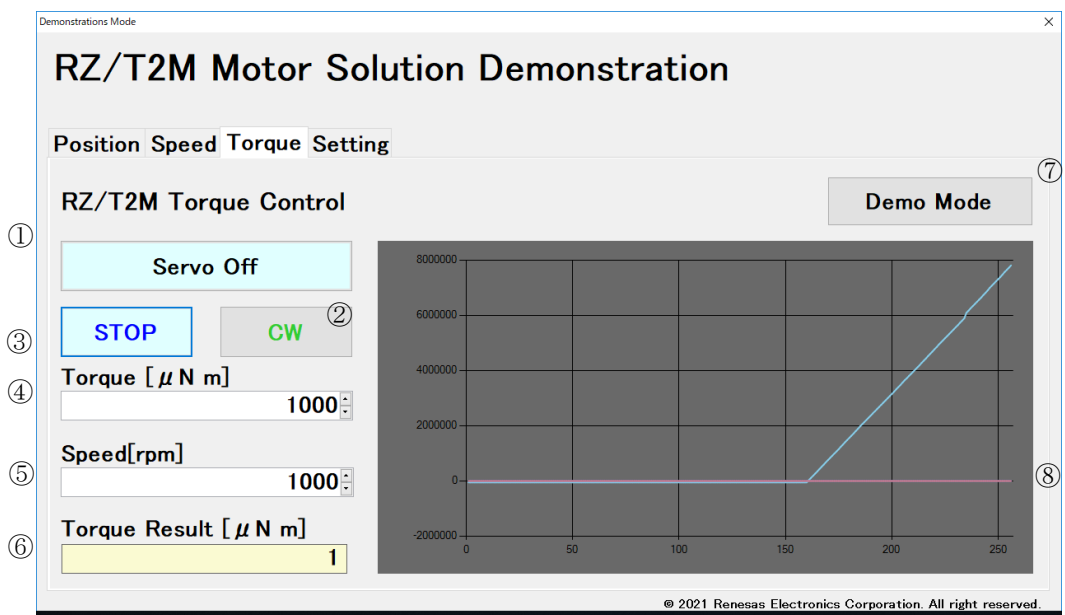

Figure 4-3 Torque Control Screen

No.	Item	Description
①	Servo On/Off	This toggle button is controlled the power supply on/off. • When this button is pressed while "Servo On" is displayed, the motor power is turned on. • When this button is pressed while "Servo Off" is displayed, the motor power is turned off.
②	RUN/STOP	This toggle button is started/stopped the torque control. • When this button is pressed while "RUN" is displayed, the motor rotates at torque[mNm] (target torque). When rotating, this toggle button is displayed "RUN" -> "STOP". • When this button is pressed while "STOP" is displayed, the motor stops emergency. When stopping, this toggle button is displayed "STOP" -> "RUN".
③	CW/CCW	This toggle button is controlled the direction of motor rotation. • When this button is pressed while "CW" is displayed, the motor rotates forward (clockwise when viewed from the output shaft side). • When this button is pressed while "CCW" is displayed, the motor rotates reverse (counter clockwise when viewed from the output shaft side).
④	Torque[uNm]	Target torque is set. 0 to 2000 [uNm] (1 step) can be set. This value can be changed while motor rotates.
⑤	Speed[rpm]	Target speed is set. 0 to 2000 [rpm] (1 step) can be set. This value can be changed while motor rotates.
⑥	Torque Result[uNm]	The current torque (result) is displayed at 100ms intervals.
⑦	Demo Mode	This toggle button is operated the Torque Control automatically. When this button is pressed while "Demo Mode" is displayed, torque control is started at the certain torque. When this button is pressed again, the motor stops. While operating Demo Mode, other buttons (RUN / STOP button, etc.) cannot be used. If other tab (Position tab/Speed tab) is pressed while operating Demo Mode, Demo Mode is stopped emergency.
⑧	Graph	Waveform of current motor position value (Blue), Pos error (Green) and Id/Iq current value (Red/Orange) are displayed at 100ms intervals as default. The variables and scaling displayed in the graph can be changed. See "5 Variables" for variables.

(3) Setting Screen

Figure 4-4 is shown the setting screen. Contents of Position tab/Speed tab/Torque tab can be configured.

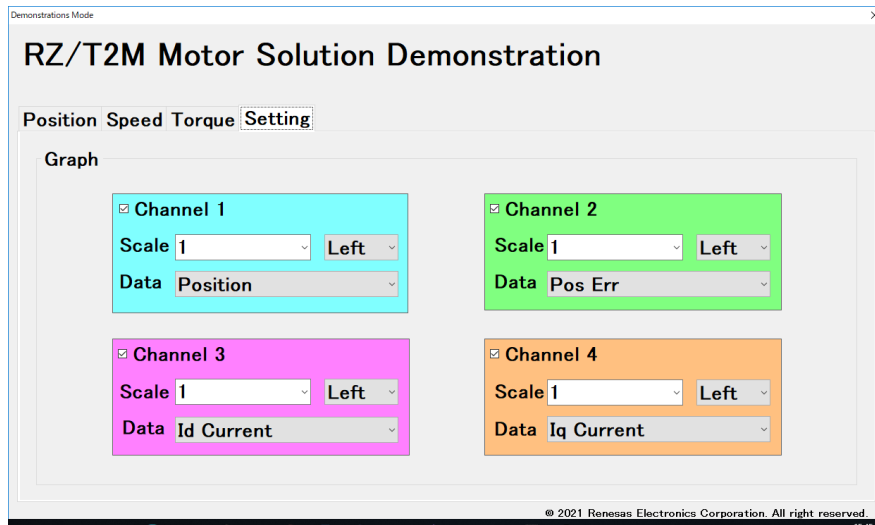

Figure 4-4 Setting Screen

■ Graph

No.	Item	Description
1	Channel1~Channel4	The show/hide of Channel1 to Channel4 graphs is set. And the graph display is valid when the check box is checked.
2	Scale	Scale is set in 0.125 units. And primary axis (left side) / secondary axis (right side) of Y axis is set with "Left" / "Right".
3	Data	The displayed data (variable) is set. Refer to "5 Variables".

4.3.3 Tuner/Analyze Mode

4.3.3.1 CN032 Motion Utility.exe Starting

■ When RS-232 is connected

Select the COM port number and “Tuner/Analyzer”. Push the “OK” button.

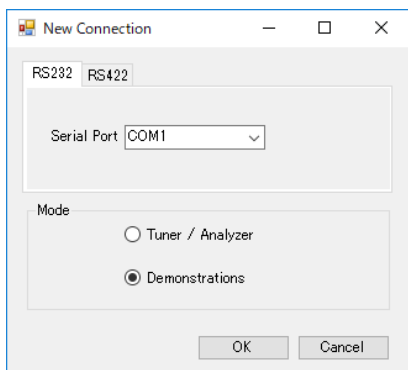

■ RS-422 is not supported

■ Display the connection error

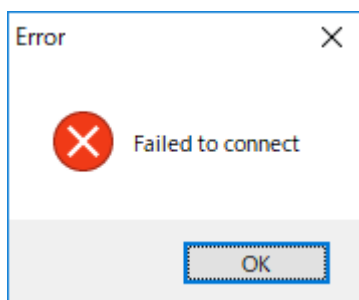

Double-check the CN032 AC Servo Solution connection (refer to “3 Board Setting”), restart the Motion Utility.

4.3.3.2 Position Control Execution

This chapter shows an execution example of Position Control. About detail specification, refer to “4.4 Tuner/Analyzer Mode Specification”.

(1) Import of the Motor Parameters

Select the [File]>[Import] of the menu and select the motor parameters in the same folder as CN032 Motion Utility.exe.

Motor: BM0602A1PD-A -> default.mtr

(2) Power ON

Push the “Power ON” button.

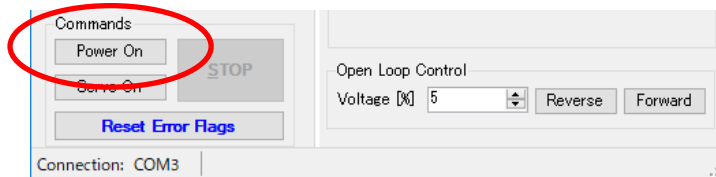

(3) Phasing Operation

Select the “Setup” tab, push the “Phase” button.

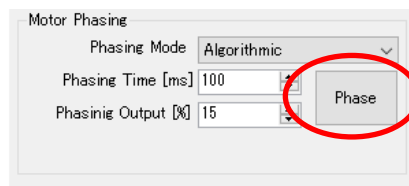

(4) Servo ON

Push the “Servo On” button.

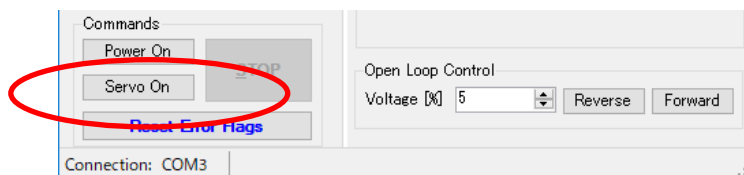

(5) Position Control

Push the “Cycle Move P1-P2” button. The position of the motor is repeated 0 or 10000.

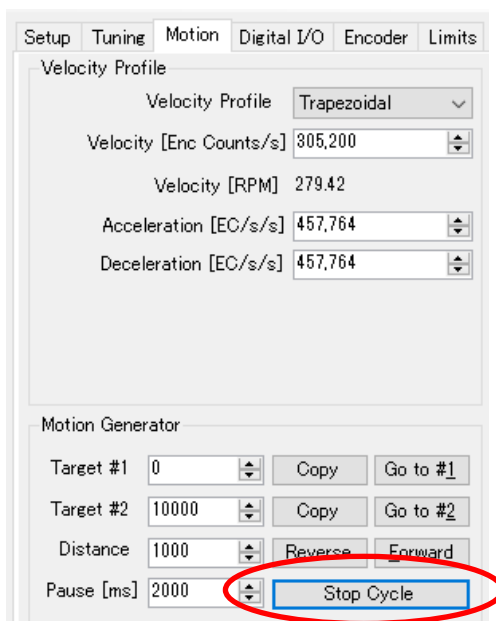

4.4 Tuner/Analyzer Mode Specification

Figure 4-5 is shown the main screen of Tuner/Analyzer mode.

Tuner/Analyzer mode is for the configuration of motor parameter, tuning and diagnostic of the Solution. This mode has a GUI (graphical user interface) that displays various parameters and commands and has a terminal emulator that can read and write variables dynamically. In addition, a Motion Scope is displayed linear graphs of important controller variables.

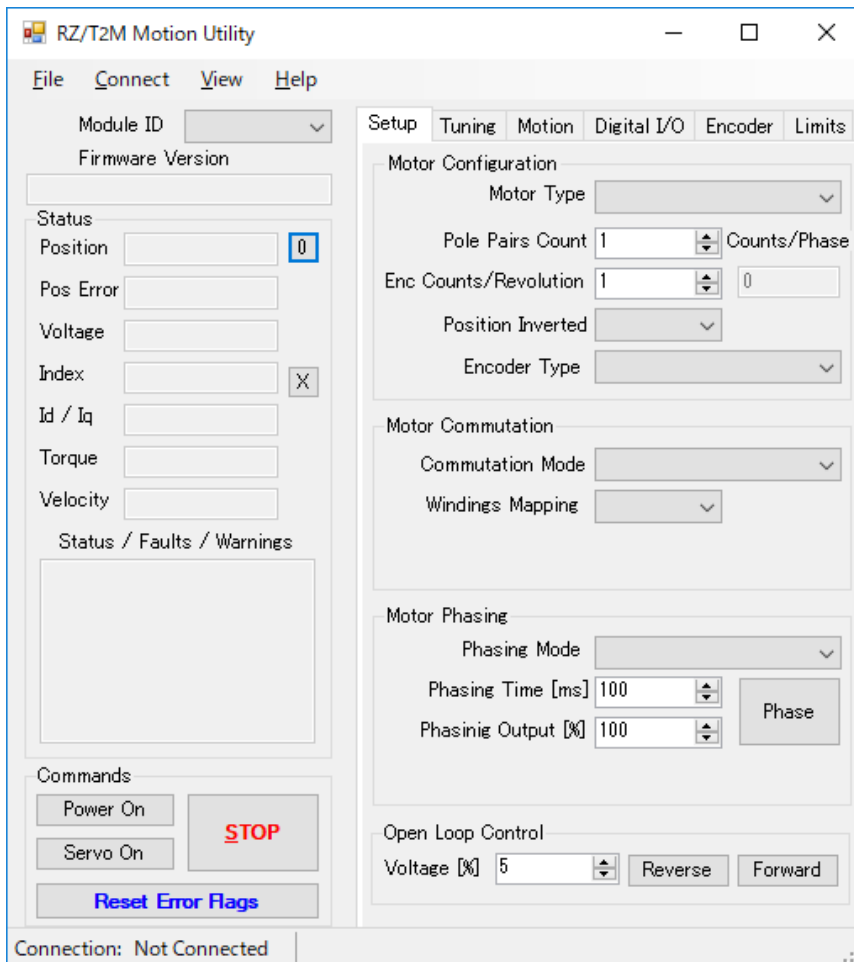
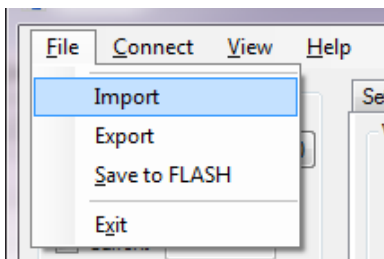

Figure 4-5 Main Screen

4.4.1 Menu

4.4.1.1 File



No.	Item	Description
1	Import	Motor parameters are imported. (Extension: *.mtr)
2	Export	Motor parameters are exported. (Extension: *.mtr)
3	Save to Flash	Motor parameters are written to the Flash ROM of the Controller board. (Address (:0xB0000~(ch1 of motor)) of Flash ROM that firmware of the solution is stored.) * Execute when the power is turned off (motor stopped). * After writing the motor parameters, turn off the power of the solution board and restart.

About motor parameters, refer to “6 Motor Parameters”.

4.4.1.2 Connect/Disconnect

■ Connect

The connection dialog offers entering connection string which describes the communication interface. The string format also defines the type of the communication protocol.

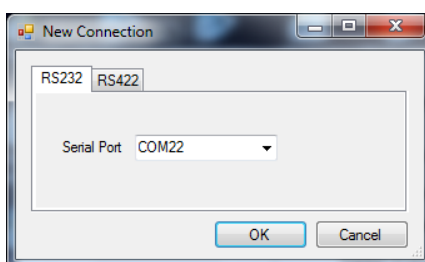

- The RS-232/ RS485 connection is implied by specifying COM followed by a number such as COM5. The baud rate is fixed at 115,200 bps
- The RS-422 connection is not supported.

■ Disconnect

The communication is disconnected. If connecting again, “Connect” is selected.

4.4.1.3 View

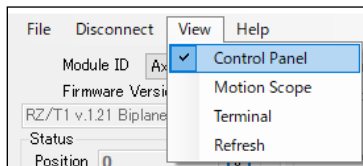

■ Control Panel

Part of the red frame is shown/ hidden.

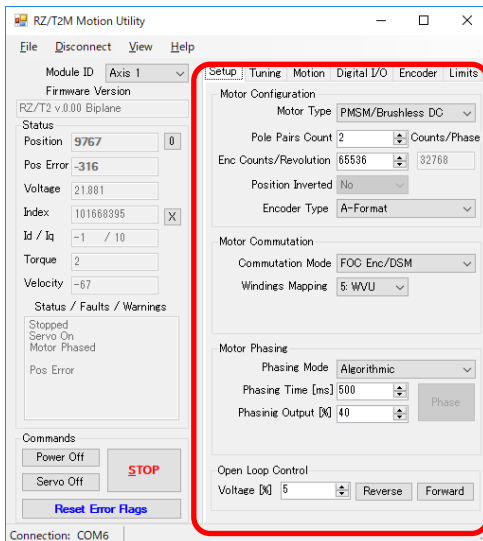

■ Motion Scope

Motion Scope screen is shown/ hidden.

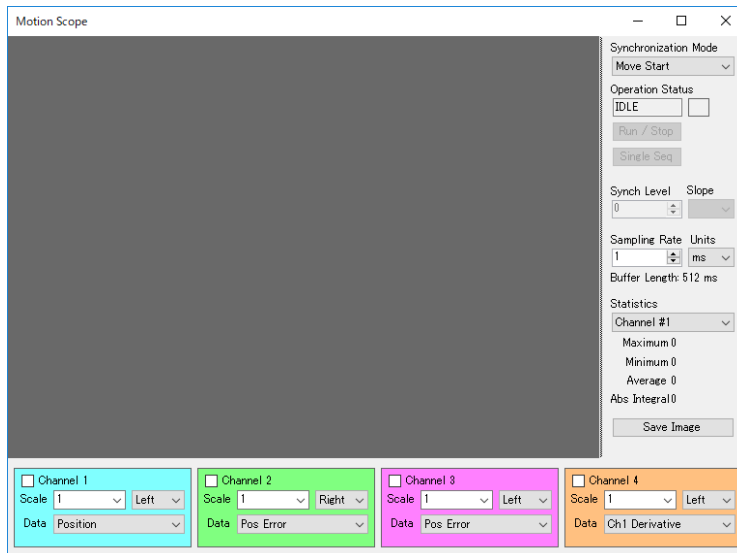

■ Terminal

Part of the red frame is shown/ hidden.

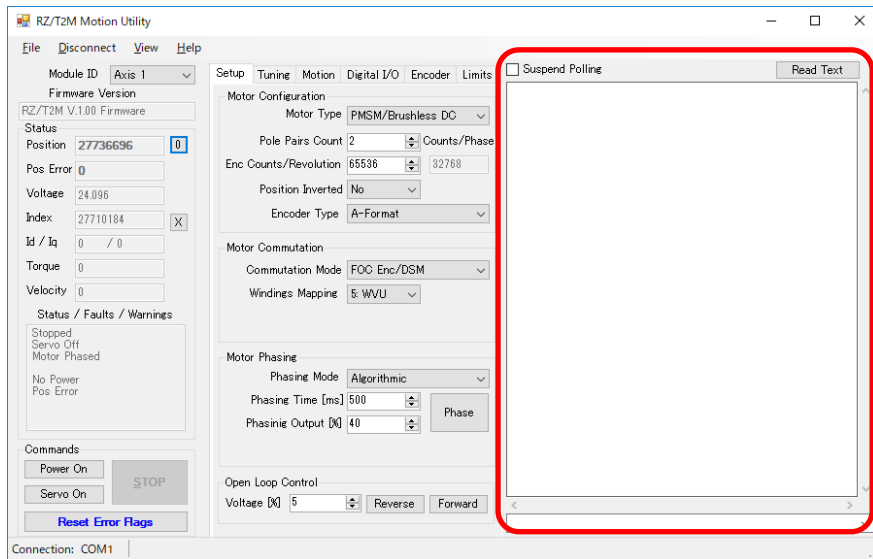

■ Refresh

Motor parameters of default (when shipping) are refreshed.

4.4.1.4 Help

■ About

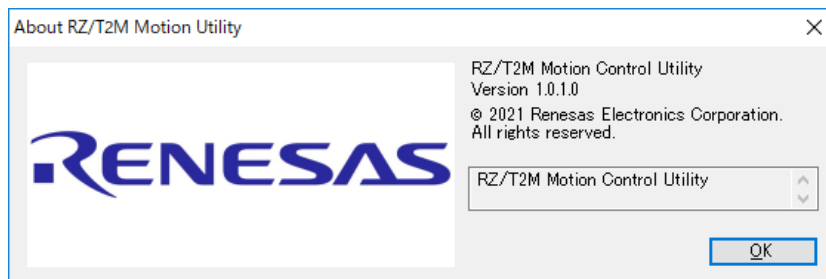

4.4.2 Main Screen

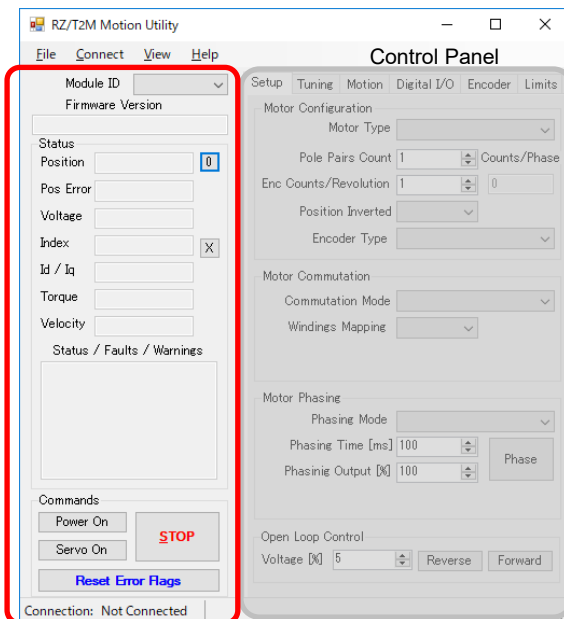

No.	Item	Description	
1	Module ID	Axis number of motor to be controlled is selected.	
2	Firmware Version	Version of the solution firmware is displayed.	
3	Status	Position	The current coordinates of the motor are displayed. If pushing "0" button, the current coordinates is 0.
4		Pos Error	The actual coordinates and the distance to the target coordinates are displayed.
5		Voltage	DC bus voltage is displayed.
6		Index	The encoder counter value (Position value) (absolute value) is displayed. Every pressing the X button is updated. Incremental encoder is displayed 0.
7		Id/Iq	The current Id/Iq value are displayed.
8		Torque	The current torque value is displayed.
9		Velocity	The current speed[rpm] is displayed.
10	Status/ Faults/ Warnings	The current status, faults and warnings are displayed. About detail, refer to "■Status/ Faults/ Warnings".	
11	Commands	Power On	This toggle button is controlled the power supply on/off.
12		Servo On	This toggle button is controlled the servo on/off.
13		STOP	This button is stopped the rotation of the motor.
14		Reset Error Flags	This button is released the status of Faults/Warnings. By releasing the status of Faults/Warnings, "Servo On" button is valid.

■ Status/ Faults/ Warnings

No.	Indication	Description
1	"Moving"/ "Stopped"	"Moving" or "Stopped" is displayed to 1st line. "Moving": The motor is rotating. "Stopped": The motor is stopping.
2	"Servo On"/ "Servo Off"	"Servo On" or "Servo Off" is displayed to 2nd line. "Servo On": The servo control is started. "Servo Off": The servo control is stopped.
3	"Power On" / "Power Off"	"Power On" or "Power Off" is displayed to 3rd line. "Power On": Power is turned ON. "Power Off": Power is turned OFF.
4	"Motor Phased"/ "Motor Not Phased"	"Motor Phased" or "Motor Not Phased" is displayed to 4th line. "Motor Phased": Motor phasing is completed. "Motor Not Phased": Motor phasing is not completed.
5	"Position Captured"	The encoder count was acquired.
6	"PVT Buffer Error"	PVT buffer capacity were less than threshold.
7	"Overcurrent"	Over current was detected.
8	"Amplifier Inhibit"	Error by "4.4.3.5(5)Other".
9	"PVT Buffer Empty"	PVT buffer empty were detected.
10	"Overtemperature"	Overheating was detected.
11	"Amplifier Fault"	Fault error from Current Sensor.
12	"Position Error"	The Max Position Error.
13	"Wraparound Error"	Position Counter Wraparound

4.4.3 Control Panel

4.4.3.1 Setup Tab

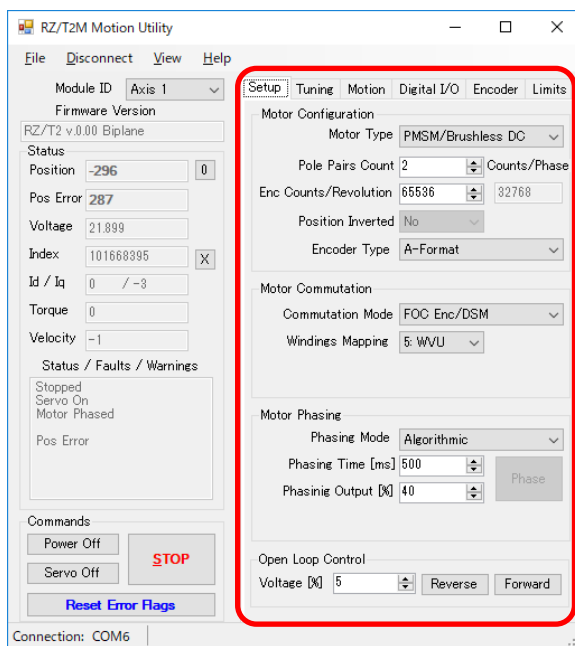

(1) Motor Configuration

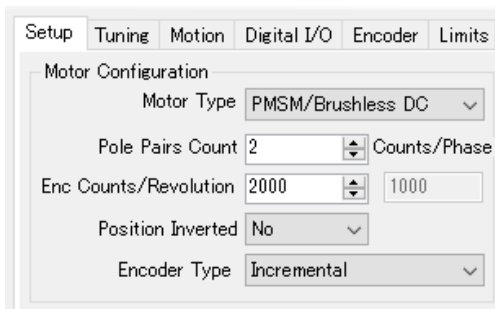

No.	Item	Description
1	Motor Type	Motor type is selected. • PMSM/Brushless DC (PMSM/ Brushless DC)
2	Pole Pairs Count	Motor pole pairs count is set. (1 to 16 can be selected.)
3	Enc Counts/Revolution	Encoder count for one revolution is set.
4	Counts/Phase	Electrical cycle (= the encoder counts per revolution divided by the number of pole pairs) is displayed.
5	Position Inverted	The position feedback can be inverted if needed. This option eliminates the need of changing the wiring of an incremental encoder if the direction motion does not correspond to the decoded position.
6	Encoder Type	Encoder Type is selected. 0: Incremental 3: FA-Coder

(2) Motor Commutation

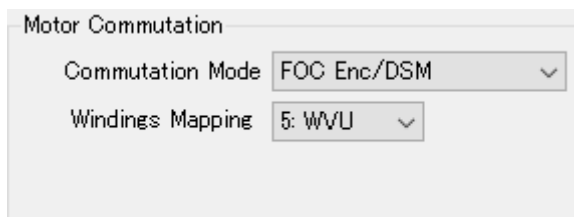

No.	Item	Description
1	Commutation Mode	Motor commutation mode is set. • "FOC Enc/DSM": Sinusoidal vector control with encoder and Delta Sigma Modulator
2	Windings Mapping	Windings Mapping (U/V/W placement.) is selected.

(3) Motor Phasing

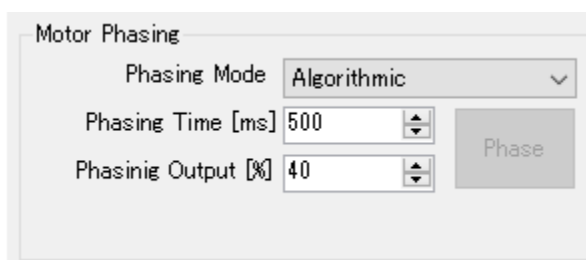

No.	Item	Description
1	Phasing Mode	Phasing mode is selected. About detail, refer to the following "■ CN032 AC Servo Solution Firmware Manual". 1. Algorithmic an algorithm is executed upon power up of the controller. It energizes the windings creating known flux orientation that rotates the motor. After a small delay that allows the motor to settle the motor position is taken as a reference for the pole's orientation. The advantage of using Algorithmic phasing is it does not need additional hardware and wiring, and its accuracy is pretty good. The disadvantage is that it executes small (half electrical cycle) but uncontrolled motion upon power up that may not be acceptable. 2. Dithering algorithm moves the magnetic flux at various angles and identifies the direction of movement based on the encoder. This algorithm may not be available in all firmware versions. The advantage is of this approach is same as the algorithmic phasing and in addition it minimizes the robot motion to several encoder counts. The disadvantage is its accuracy is affected by the motor load, so it is not applicable to gravity or spring-loaded axes. The phasing process can be initiated at any time by pressing the Phase button. The controller power must be turned on.
2	Phasing Time [ms]	Phasing time is set. The voltage is applied with magnitude defined by the motor variable motor power for a duration defined in the motor variable phasing time. When Phasing Mode is Hall-Based, this item cannot be selected.
3	Phasing Output [%]	Phasing Output is set. The voltage is applied with magnitude defined by the motor variable motor power for a duration defined in the motor variable phasing time. When Phasing Mode is Hall-Based, this item cannot be selected.
4	Phase Button	Phasing is started.

Phasing Procedure	Description
Forced Phasing phasing_mode == 0	<p>In this mode the firmware forms a voltage vector a known angle. It is formed by applying appropriate PWM duty cycle to each of the three phase outputs.</p> <p>The voltage is applied with magnitude defined by the motor variable motor_power for a duration defined in the motor variable phasing_time. These two variables have to be configured so that they will cause the motor to rotate its rotor such that it is oriented along the orientation of the magnetic flux. Once the time expires, the algorithm stores the current position and sets the phase origin 90degrees back from it.</p> <p>This procedure is implemented in the function forced_phasing() in the file m_phasing.c</p> <p>The pros of this function are its simplicity and robustness. The cons are the small move in random direction the motor would make during the procedure execution. Another disadvantage is that the motor should have no static friction or gravity load that would affect the proper rotor orientation.</p>
Dithering Based Phasing phasing_mode == 2	<p>The dithering algorithm is derived from the Forced phasing algorithm – identifying the rotor position by observing its position after known flux is applied for a certain time.</p> <p>Unlike the Forced phasing algorithm, the Dithering algorithm does not wait for a certain time – instead it monitors the position change of the rotor. Once the motion direction is detected, the flux orientation is changed so that it cause change in the opposite direction. The magnitude of the flux angle changes is gradually reduced until the motion is no longer detected. The end result is motor phasing that only includes small motor vibrations for a short time as part of the phasing.</p> <p>This algorithm has the benefits of the Forced Phasing algorithm but without the drawback of unwanted motion. The cons are the need of carefully tuning the algorithm parameter in order to match the dynamic characteristics of the mechanical system the motor is attached to. The presence of static friction and gravity load are also undesired.</p> <p>The algorithm is implemented by the function dither_phasing() in the file m_phasing.c</p>

(4) Open Loop Control

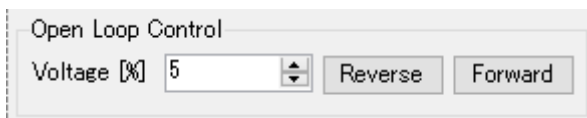

No.	Item	Description
1	Voltage [%]	The voltage (speed) to rotate is set. 1 to 99% can be set. If increasing this value, rotation of motor is fast.
2	Reverse Button	The motor rotates with Voltage (reverse). Motor reverses while the "Reverse" button is pushed. Motor stops when the "Reverse" button is released.
3	Forward Button	The motor rotates with Voltage (forward). Motor forwards while the "Forward" button is pushed. Motor stops when the "Forward" button is released.

4.4.3.2 Tuning Tab

Set the position loop, speed loop, and current loop on the Tuning tab.

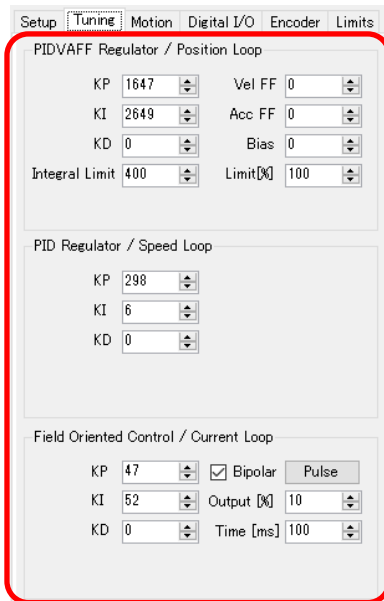

(1) PIDVAFF Regulator/Position Loop

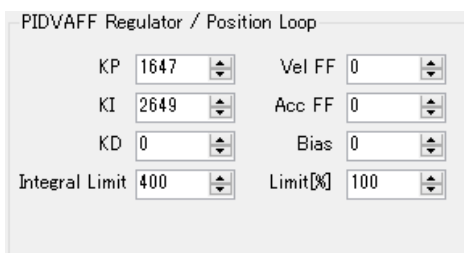

No.	Item	Description
1	KP	Proportional Gain in the position control loop algorithm (0 - 32767).
2	Vel FF	Velocity Feed Forward in the position control loop algorithm (0 - 32767).
3	KI	Integral Gain in the position control loop algorithm (0 - 32767).
4	Acc FF	Acceleration Feed Forward in the position control loop algorithm (0 - 32767).
5	KD	Differential Gain in the position control loop algorithm (0 - 32767).
6	Bias	Value to be added to the output of the PID regulator continuously.
7	Integral Limit	Integral Limit in the position control loop algorithm (0 - 32767).
8	Limit [%]	Motor output limit from the position loop PID regulator (0 - 32767)

■ PID regulator of position control

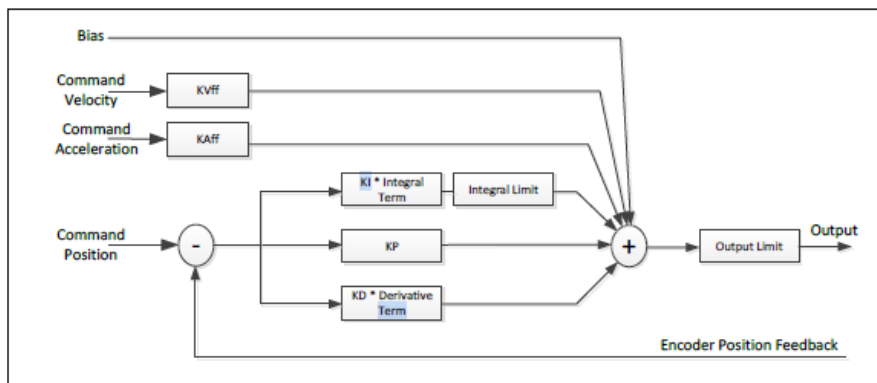
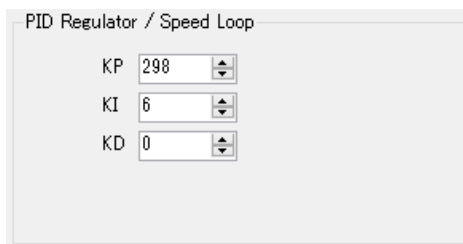

Figure 4-6 PID regulator

(2) PID Regulator/Speed Loop



No.	Item	Description
1	KP	Proportional Gain in the velocity control loop (0 - 32767).
2	KI	Integral Gain in the velocity control loop (0 - 32767).
3	KD	Differential Gain in the velocity control loop (0 - 32767).

(3) Field Oriented Control/Current Loop

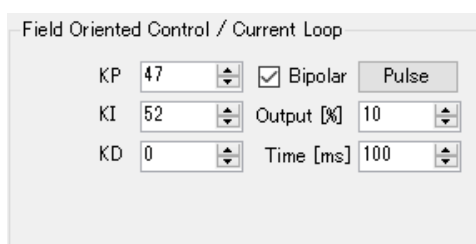

No.	Item	Description
1	KP	Proportional gain in the Quadrature current control loop (0 - 32767).
2	Bipolar/Pulse Button	When this button is pushed, a pulse of the specified magnitude (Output [%]) for the specified time (Time [ms]) is output. When "Bipolar" is checked, bipolar pulses (positive pulse and negative pulse) are output. When "Bipolar" is not checked, a unipolar pulse (positive pulse) is output.
3	KI	Integral gain in the Quadrature current control loop (0 - 32767).
4	Output [%]	Output voltage set as PWM duty cycle (32767 = 100%). Requires that the servo control is turned off.
5	KD	Differential Gain in the Quadrature current control loop (0 - 32767).
6	Time [ms]	Time of PWM output is set.

4.4.3.3 Motion Tab

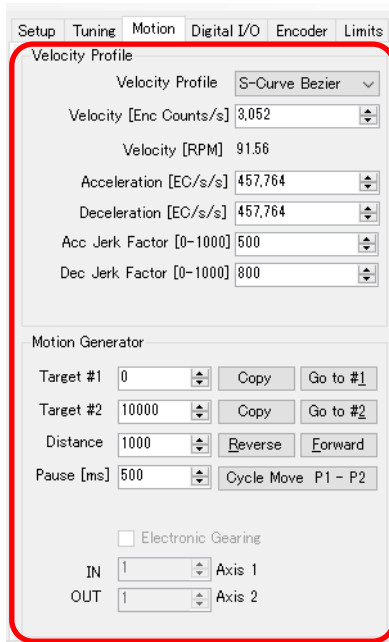

(1) Velocity Profile

About Velocity Profile, “Trapezoidal”, “Spline-Curve”, “Bezier-Curve” and “PVT Streaming” are selected.

(a) Velocity Profile : Trapezoidal and Spline-Curve

The Trapezoidal Profile: The definition of maximum velocity, acceleration and deceleration are set. Note that the motion parameters are maximum values that may not be achievable given the distance to the target position and the abilities of the motor.

The Spline-Curve Profile: Provides smooth velocity profile curve and eliminates the vibrations caused by the sudden start and stop of acceleration typical for the Trapezoidal velocity profile. The smooth motion comes at the expense of extended time to execute the same motion.

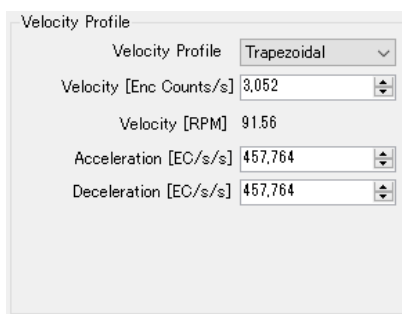

No.	Item	Description
1	Velocity [Enc Counts/s]	Maximum velocity is set.
2	Velocity [rpm]	The value converted the maximum speed to rpm is displayed.
3	Acceleration [EC/s/s]	Maximum acceleration is set.
4	Deceleration [EC/s/s]	Maximum deceleration is set.

(b) Velocity Profile : Bezier-Curve

Bezier-Curve Profile: Setting of acceleration and deceleration jerk parameters are valid. These values can be set in the range between 0 and 1000 and change the shape of the respective acceleration and deceleration profile phases. The configurable jerk allows tradeoff between the performance and the settle time affected by aggressive deceleration.

The PVT Streaming Profile is intended to demonstrate the use of PVT mode which employs the host computer as master velocity profile generator. This approach is valuable for the synchronization of multiple axes and complex mechanisms.

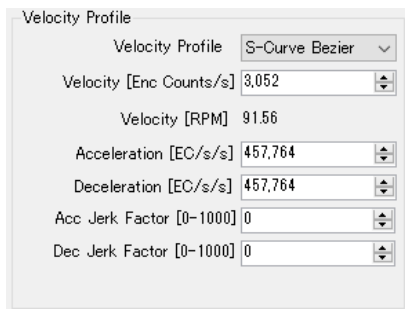

No.	Item	Description
1	Velocity [Enc Counts/s]	Maximum velocity is set.
2	Velocity [rpm]	The value converted the maximum speed to rpm is displayed.
3	Acceleration [EC/s/s]	Maximum acceleration is set.
4	Deceleration [EC/s/s]	Maximum deceleration is set.
5	Acc Jerk Factor [0-1000]	Acceleration Jerk (0 - 1000) is set.
6	Dec Jerk Factor [0-1000]	Deceleration Jerk (0 - 1000) is set.

■References:

< The Trapezoidal Profile >

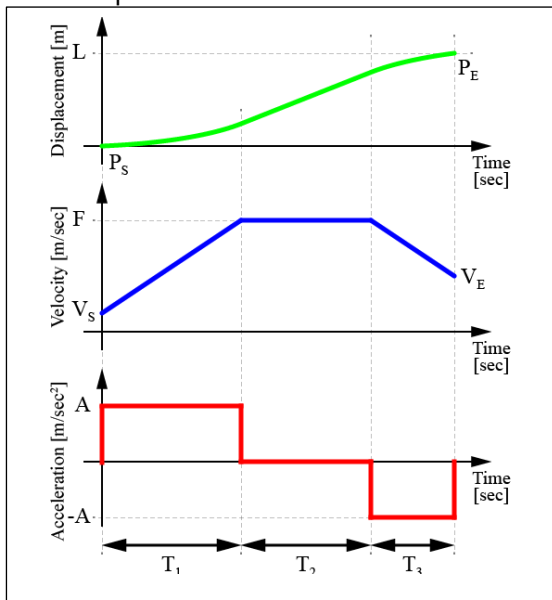

< Bezier-Curve Profile >

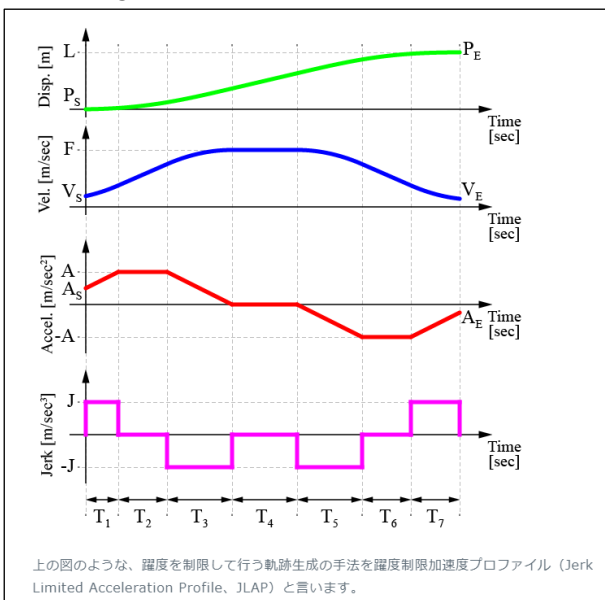

(c) Velocity Profile : PVT Streaming

PVT Streaming Profile (PVT= position Velocity Time): Since the communication bandwidth between the host and the controller is inherently limited, the velocity profiles are presented as sets of Position and Velocity over a fixed time slices (typically 5ms to 20ms). Hence the name Position-Velocity-Time for these profile time. The PVT points are streamed to each of the controllers which in turn execute interpolation algorithm to generate the desired position and velocity set-points each microsecond.

No.	Item	Description
1	Velocity [Enc Counts/s]	Maximum velocity is set.
2	Velocity [rpm]	The value converted the maximum speed to rpm is displayed.
3	Acceleration [EC/s/s]	Maximum acceleration is set.
4	Deceleration [EC/s/s]	Maximum deceleration is set.
5	Acc Jerk Factor [0-1000]	Acceleration Jerk (0 - 1000) is set.
6	Dec Jerk Factor [0-1000]	Deceleration Jerk (0 - 1000) is set.
7	PVT Time Slice [ms]	PVT Time is set.

(2) Motion Generator

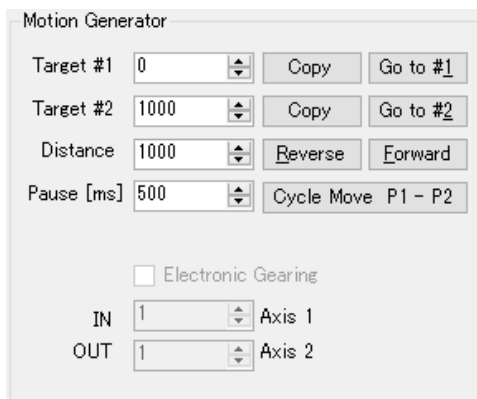

No.	Item	Description
1	Target #1/ Copy Button/ Go to #1 Button	Position of target #1 is set. When pushing "Copy" button, Current position is copied. When pushing "Go to #1" button, the motor rotates to the Position of Target #1.
2	Target #2/ Copy Button/ Go to #2 Button	Position of target #2 is set. When pushing "Copy" button, Current position is copied. When pushing "Go to #2" button, the motor rotates to the Position of Target #2.
3	Distance/ Reserve Button/ Forward Button	Distance (Position) is set. When pushing "Reserve" button, the motor rotates reverse to the "Distance". When pushing "Forward" button, the motor rotates forward to the "Distance".
4	Pause [ms]/ Cycle Move P1-P2 Button	When pushing "Cycle Move P1-P2" button, repeat the following. ① The motor rotates to the Target #1. ② Pause ③ The motor rotates to the Target #2. ④ Pause When pushing "Cycle Move P1-P2" button again, the motor stops.

4.4.3.4 Encoder Tab

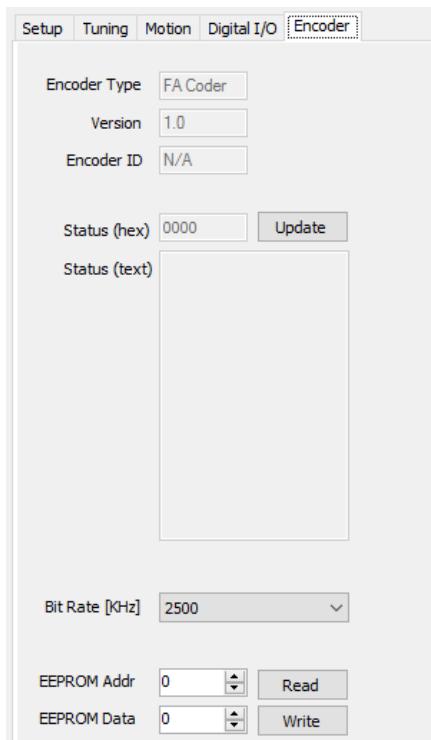

No.	Item	Description
1	Encoder Type	Encoder Type is displayed. When customer uses custom encoder, "Custom" is displayed.
2	Version	Encoder version is displayed.
3	Encoder ID	Encoder ID is displayed.
4	Status(hex)	Error Status of Encoder is displayed in 16-bit HEX.
5	Status(text)	Error Status of Encoder is displayed in character.
6	update Button	Error Status of encoder is updated.
7	Bit Rate [kHz]	Bit Rate[kHz] of encoder (Absolute Encoder) is selected.
8	Read Button	The value of the EEPROM address of Absolute Encoder is read. When pushing the "Read" button, the value of the "EEPROM Addr" is read and the read result is displayed in "EEPROM Data".
9	Write Button	When pushing the "Write" button, the value of the "EEPROM Data" is written to address of "EEPROM Addr".

■ Encoder Error Status

Bit	Indication
0	Overspeed Error
1	Initialization Error
2	Counting Error
3	Multi-turn Overflow
4	N.C
5	Multi-turn Error
6	Battery Error
7	Battery Alarm
8	EEPROM Busy
9	EEPROM Error
10	N.C
11	N.C
12	N.C
13	N.C
14	N.C
15	N.C

4.4.3.5 Limits tab

The follow error detection can be set.

- Motor position deviation
- Overcurrent
- Over voltage of DC bus voltage
- Under voltage of DC bus voltage
- Motor overload pre-detection
- Motor position error (upper limit / lower limit)
- Motor upper limit speed
- Motor speed deviation
- PVT buffer empty

(1) Motor Protections/I2t Limits

No.	Item	Description
1	Max Position Error[ec]	Max Position Error is set.
2	Max Position Error Action	When the position is greater than or equal to the Max Position Error, the action is set. 0: "None": No action. 1: "Stop": Servo Off 2: "Off": Servo Off and Power Off
3	I2t Crnt[mA]/ Time[ms]	Motor overheating current [mA] and overheating time [ms] are set. This protection is slow because it integrates the square of the current exceeding the nominal over. Once this protection is activated the output current is limited, but the motions is not stopped.
4	Over Crnt[mA]/ Time[ms]	The over current [mA] and the over current detection time [ms] are set.

(2) Inverter Limits

No.	Item	Description
1	Min.Voltage [V]	Under voltage of DC bus voltage is set.
2	Max.Voltage[V]	Over voltage of DC bus voltage is set.
3	Overload pre-detect[mA]	The Overload pre-detect is set.

(3) Position Control Limits

Position Control Limits

Minimum Position [EC] -150000

Maximum Position [EC] 150000

No.	Item	Description
1	Minimum Position [EC]	The lower limit of position error detection is set. When pushing "Copy" button, position of "4.4.2 Main Screen" is copied.
2	Maximum Position [EC]	The upper limit of position error detection is set. When pushing "Copy" button, position of "4.4.2 Main Screen" is copied.

(4) Speed Control Limits

Speed Control Limits

Max Speed [EC/s] 45776

Instructed Speed Diff[EC/s] 1526

No.	Item	Description
1	Max Speed [EC/s]	Max speed is set.
2	Instructed Speed Diff [EC/s]	The motor speed deviation is set.

(5) Other

PVT Buffer Empty Level

Error Flags (click to decode)

Error Mask

No.	Item	Description
1	PVT Buffer Empty Level	PVT buffer empty level is set.
2	Error Flags/ Read Button	Current detected Error is displayed. When pushing "Read" button, detected Error is updated. About errors for bits, refer to " ■ Error detection setting screen".
3	Error Mask/ Edit Button	Enables / disables for each error are set. When pushing "Edit" button, Enables / disables for each error can be set.

■ Error detection setting screen

For items checked in the check box, motor stop when error detection is activated. The item whose item name is bold is the item where the error is currently detected.

Bit	Item	Bit	Item
0	N.C	16	Forward Limit Switch Triggered
1	N.C	17	Position Error
2	N.C	18	Abnormal Position
3	N.C	19	Instructed speed difference
4	N.C	20	Over Speed
5	N.C	21	Overload pre-detect
6	N.C	22	Ground Fault
7	PVT Buffer Empty	23	Inverter Over Temperature
8	Switch Setting Error	24	Motor Over Temperature
9	Invalid Parameter Setting	25	Inverter Fault
10	Encoder Not Detected	26	Inverter Over Current
11	Home Procedure Error	27	Inverter Over Voltage
12	Home Procedure Incomplete	28	Inverter Under Voltage
13	Minimum Limit Position	29	Memory Error
14	Reverse Limit Switch Triggered	30	CPU Voltage Drop
15	Maximum Limit Position	31	Watch Dog Timeout

4.4.4 Motion Scope

The Motion Scope can be resized and positioned independently from the main control window. The Motion Scope has four channels that can be configured to visualize various motion controller variables in line chart form. It is important to note that the data capture always takes place in the motion controller and the Motion Scope only visualizes the result from the data capture. This is done to allow very high rate of data acquisition independent from the communication bandwidth between the controller and the Windows application.

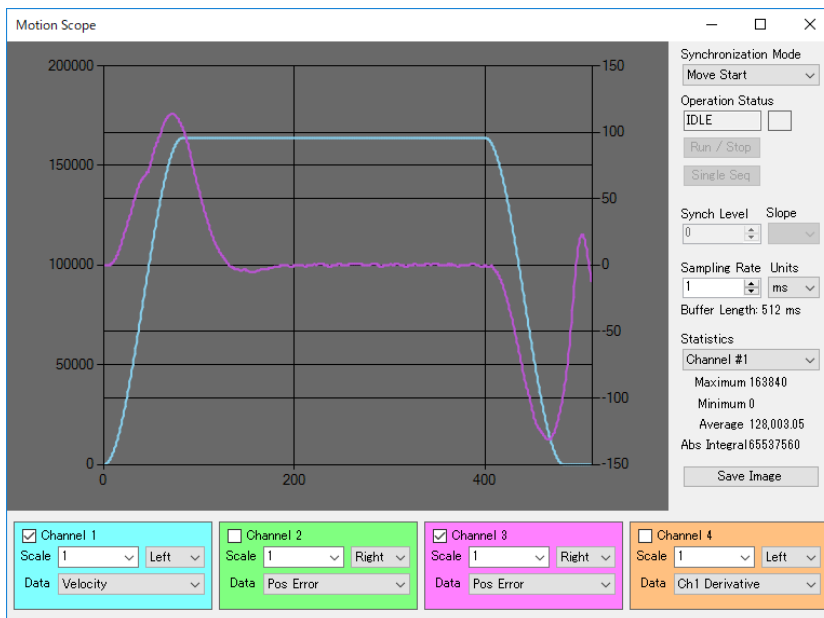

No.	Item	Description
1	Synchronization Mode	Synchronization Mode is selected. Move Start: Waveform data is collected by triggered the start of position control. Move End: Waveform data is collected by triggered the stop of position control. Manual: Waveform data is collected asynchronously with the operation of the motion controller.
2	Operation Status	Operation Status is displayed. IDLE: Idle status. The back color of the Status Panel on the right is transparent. TRANSFER: Under collecting waveform data. The back color of the Status Panel on the right is orange. RECORD: Waveform data collection completed. The back color of the Status Panel on the right is red.
3	RUN/STOP Button	Waveform data collection is started / stopped.
4	Single Seq	when pushing "Single Seq" button, waveform data is collected once.
5	Synch Level/Slope	Level and slope (Rising edge / Falling edge) are set. Synchronization Mode: Manual is valid only.
6	Sampling Rate/ Units	Sampling rate is set. Minimum is 50 μ s. "Units" is selected μ s or ms. The sampling number of waveform data are 512 or less. Ex: When the sampling rate is set to 50 μ s, the waveform for 25.6 ms (= 50 μ s x 512) is displayed.
7	Statistics	The statistical data (maximum value / minimum value / mean value / integral value of absolute value of sampling data) of the selected channel are displayed.
8	Save Image	Waveform is saved in PNG format or waveform data is saved in CSV format.

The graph can be changed scale by operating the mouse. Zoom in is clicked the corner of the graph and dragged to the desired range. Zoom out is clicked the edge of the scroll bar.

Motion scope can display waveform of 4 channels and show/hide at check box.

The screenshot shows four channel configuration panels:

- Channel 1 (Cyan):** Channel 1, Scale: 1, Left, Data: Velocity
- Channel 2 (Green):** Channel 2, Scale: 1, Right, Data: Pos Error
- Channel 3 (Magenta):** Channel 3, Scale: 1, Right, Data: Phase Angle
- Channel 4 (Orange):** Channel 4, Scale: 1, Left, Data: Ch1 Derivative

No.	Item	Description
1	Scale	Scale is set at 0.125 units. And primary axis (left side) / secondary axis (right side) of Y axis is set with "Left" / "Right".
2	Data	Waveform data (variables) is selected. Refer to "5 Variables".

4.4.5 Terminal

The Terminal Emulator allows communicating the motion controllers using ASCII commands. This is helpful when certain command is not available as a button or when the status does not include information about some internal state. The commands are entered at the bottom of the screen and. The Up/Down arrow keys can bring the history of the recently issued commands. (Not supported on RS-422.)

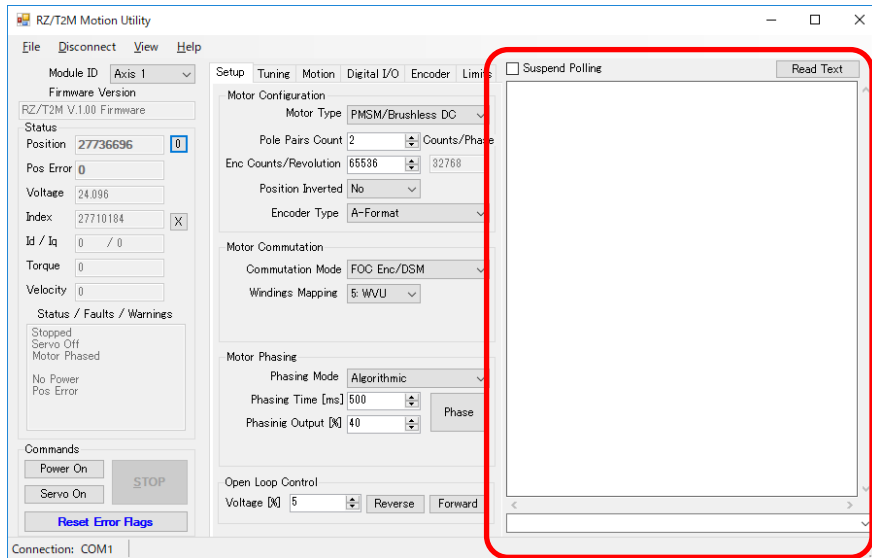

No.	Item	Description
1	Suspend Polling	When checking “Suspend Polling”, the acquisition of information (Position, DC bus voltage value, etc.) from the solution is stopped.
2	Read the text file Button	The text file that the command is written is executed.

5. Variables

Table 5-1 is shown the variables that can be displayed in a graph.

Table 5-1 Variables that can be displayed in a graph

No.	Variable	Description
1	Position	Motor Position
2	Velocity	Velocity
3	Acceleration	Acceleration
4	I2t Accumulator	I2t Integral
5	Pos Err	Position Error
6	PID Output	PID Regulator Output Value
7	Id Current	Direct Current
8	Iq Current	Quadrature Current
9	Id Current Err	Direct Current Error
10	Iq Current Err	Quadrature Current Error
11	ADC1 Value	U Phase A/D Converter Value
12	ADC2 Value	V Phase A/D Converter Value
13	ADC3 Value	W Phase A/D Converter Value
14	PVT Points	PVT FIFO Buffer Depth
15	D Voltage	FOC Voltage Output D
16	Q Voltage	FOC Voltage Output Q
17	RT Counter	-
18	Phase Angle	Phase Angle
19	Input Capture	Current C (Input Capture Value)
20	Position Err	Position Error (pos_err detail)
21	Pos Control Integral	Position Control Integral
22	Velocity Err	Velocity Error
23	Vel Control Integral	Velocity Control Integral
24	Id Control Integral	Id Control Integral
25	Iq Control Integral	Iq Control Integral
26	Torque Estimate	Motor Torque Estimate
27	Motor Electric Angle	Motor Electric Angle

6. Motor Parameters

Table 6-1 is shown the Motor Parameters of BM0602A1PD-A.

Table 6-1 BM0602A1PD-A Motor Parameters

No	Item	Description	BM0602A1PD-A
			Absolute
1	Version	N.C	0
2	NodeId	N.C	0
3	ModuleType	Module Type 2: Electronic gearing mode is valid 3: Electronic gearing mode is invalid	3
4	MotorType	Motor Type 3 : PMSM/Brushless DC 4 : Induction Motor	3
5	EncoderType	Encoder Type 0 : Incremental 1 : Endat 2.2 2 : BiSS 3 : FA-Coder 4 : A-format™ 5 : Hiperface DSL 6 : Custom	3
6	CommutationMode	Communication Mode 4: Sinusoidal vector control with encoder and Delta Sigma Modulator 5: Sinusoidal vector control with encoder and CT 6: Sinusoidal vector control with CT	4
7	PhaseCounts	Electrical cycle (= the encoder counts per revolution divided by the number of pole pairs)	13107
8	EncoderCounts	Encoder count for one revolution	65536
9	PolePairs	Motor pole pairs count	5
10	HallInvert	N.C	0
11	PosInvert	CW/ CCW of motor 0: CW, 1: CCW	0
12	PhaseOffset	N.C	0
13	PhaseMap	Windings Mapping (U/V/W placement.)	6
14	PhaseScale	N.C	-5
15	PhasingMode	Phasing Mode 0 : Algorithmic 2 : Dithering	0
16	PhasingTime	Phasing Time[ms]	500
17	PhasingPower	Phasing Output[%]	20
18	Ds	Desired position loop cycle time [us]	100(=62.5us)
19	Kp	Proportional Gain in the position control loop algorithm	1648
20	Ki	Integral Gain in the position control loop algorithm	100
21	Kd	Differential Gain in the position control loop algorithm	0
22	Il	Integral Limit in the position control loop algorithm	1000
23	Vff	Velocity Feed Forward in the position control loop algorithm	0
24	Aff	Acceleration Feed Forward in the position control loop algorithm	0
25	Bias	Value to be added to the output of the PID regulator continuously.	0
26	Iqkp	Proportional gain in the Quadrature current control loop	7
27	Iqki	Integral gain in the Quadrature current control loop	40
28	Iqkd	Differential Gain in the Quadrature current control loop	0
29	Vqkp	Proportional Gain in the velocity control loop	5
30	Vqki	Integral Gain in the velocity control loop	1

RZ/T2M Group, RZ/T2L Group, RZ/N2L Group Startup Guide (for Motion Control Utility)

No	Item	Description	BM0602A1PD-A
			Absolute
31	Vqkd	Differential Gain in the velocity control loop	0
32	MinVolt	Under voltage of DC bus voltage	2600
33	MaxVolt	Over voltage of DC bus voltage	3000
34	MinPos	The lower limit of position error detection	- 6553600
35	MaxPos	The upper limit of position error detection	6553600
36	MaxVel	Max speed	45776
37	MaxVelDiff	The motor speed deviation	1526
38	MaxTemp	N.C	0
39	OvrCmnt	Overload pre-detect [mA]	1000
40	MinBuffer	PVT buffer empty level	10
41	ErrMask	Error Mask	0
42	Vcomp	N.C	0
43	MaxErr	Max Position Error	16384
44	MaxErrTime	N.C	0
45	MaxOutput	Motor output limit from the position loop PID regulator	100
46	CurrentLimit	The over current [mA]	1000
47	CurrentTime	over current detection time [ms]	10
48	I2TLimit	Motor overheating current [mA]	0
49	I2TTime	Motor overheating time [ms]	0
50	AutoBrake	N.C	0
51	ErrorInputMask	N.C	0
52	HomeFlagMask	Home Mask	0
53	AutoStopMode	Max Position Error Action 0: "None": No action. 1: "Stop": Servo Off 2: "Off": Servo Off and Power Off	0
54	HallShift	N.C	0
55	ApeBaudrate	Bit Rate[kHz] of encoder (Absolute Encoder)	4000
56	GearingIn	Input value of Electronic Gearing function	0
57	GearingOut	Output value of Electronic Gearing function	0

7. Appendix

7.1 Package Folder Structure

	*XX: Revision *<>: Folder name
< r12an0123xxXXXX-cn032-ac-servo-solution>	
-- <Software>	
-- <Firmware>	//CN032 AC Servo Solution Firmware Folder
-- <rzn2l>	
--Common	// Common source file for GCC and EWARM
+--Project	
-- <gcc>	//GCC project for RZ/N2L
+- <icarm>	//EWARM project for RZ/N2L
-- <rzn2l>	
--Common	// Common source file for GCC and EWARM
+--Project	
-- <gcc>	//GCC project for RZ/T2L
+- <icarm>	//EWARM project for RZ/T2L
+- <rzt2m>	
--Common	// Common source file for GCC and EWARM
+--Project	
-- <gcc>	//GCC project for RZ/T2M
+- <icarm>	//EWARM project for RZ/T2M
+- <MotionUtility>	//CN032 Motion Control Utility Folder
+- <Document>	//Manual, etc Folder
-- <Motor>	//Motor specification Folder
-- <Board>	//Controller board and Inverter board Folder
-- r12um0044ejXXXX-rzt2m-rzn2l-cn032-hardware.pdf	//Hardware Manual for RZ/T2M, RZ/N2L
-- r12um0051ejXXXX-rzt2l-cn032-hardware.pdf	//Hardware Manual for RZ/T2L
--r12um0055ecXXXX-cn032-inverter.pdf	// Hardware Manual for Inverter board
-- r11um0169ejXXXX-rzt2m-cn032-firmware.pdf	//Firmware Manual
-- r12an0123ejXXXX-rzt2m-cn032-startup-tuningtool.pdf	//This document
+- r12an0124ejXXXX-rzt2m-cn032-startup-ethercat.pdf	//Startup guide for Motion Control via EtherCAT

7.2 How to Install Development Environments

7.2.1 Development Environments Install







AC Servo Solution Kit (RZ/T2M, RZ/T2L)

Download e2studio or FSPSC for **RZT FSP v1.3.0** from the following web site.

[Release v1.3.0 · renesas/rzt-fsp · GitHub](#)

Download “setup_rztfsp_v1_3_0_e2s_v2023_07.exe” for FSP with e2studio installer.

If using IAR, download “setup_rztfsp_v1_3_0_rzsc_v2023_07.exe” for smart configurator installer.

▼ Assets 7		
 fsp_documentation_v1.3.0.zip	3.53 MB	Sep 6
 RZT_FSP_Packs_v1.3.0.exe	40 MB	Sep 6
 RZT_FSP_Packs_v1.3.0.zip	36.6 MB	Sep 6
 setup_rztfsp_v1_3_0_e2s_v2023-07.exe	1.96 GB	Sep 16
 setup_rztfsp_v1_3_0_rzsc_v2023-07.exe	588 MB	Sep 8
 Source code (zip)		Sep 6
 Source code (tar.gz)		Sep 6

AC Servo Solution Kit (RZ/N2L)

Download e2studio or FSPSC for **RZN FSP v1.3.0** from the following web site.

[Release v1.3.0 · renesas/rzn-fsp · GitHub](#)

Download “setup_rznfsp_v1_3_0_e2s_v2023_07.exe” for FSP with e2studio installer.

If using IAR, download “setup_rznfsp_v1_3_0_rzsc_v2023_07.exe” for smart configurator installer.

▼ Assets 7		
 fsp_documentation_v1.3.0.zip	3.57 MB	Sep 26
 RZN_FSP_Packs_v1.3.0.exe	33.4 MB	Sep 26
 RZN_FSP_Packs_v1.3.0.zip	30 MB	Sep 26
 setup_rznfsp_v1_3_0_e2s_v2023-07.exe	1.95 GB	Sep 27
 setup_rznfsp_v1_3_0_rzsc_v2023-07.exe	580 MB	Sep 27
 Source code (zip)		Sep 26
 Source code (tar.gz)		Sep 26

If using IAR, download IAR Embedded Workbench® for Arm Version 9.32.2 from IAR web site.

[Products | IAR Systems](#)

7.2.2 Toolchain Install

When using e² studio, install the toolchain “GNU ARM Embedded 9.3.1” by following the steps below.

(1) Select the “Add Renesas Toolchains” item from the “Help” menu.

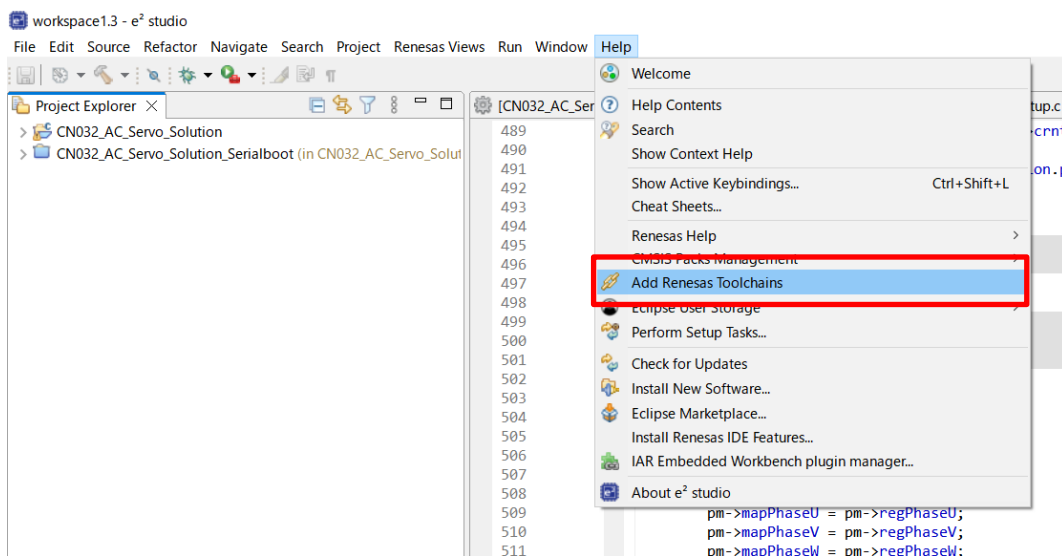

(2) Click “Download...” button.

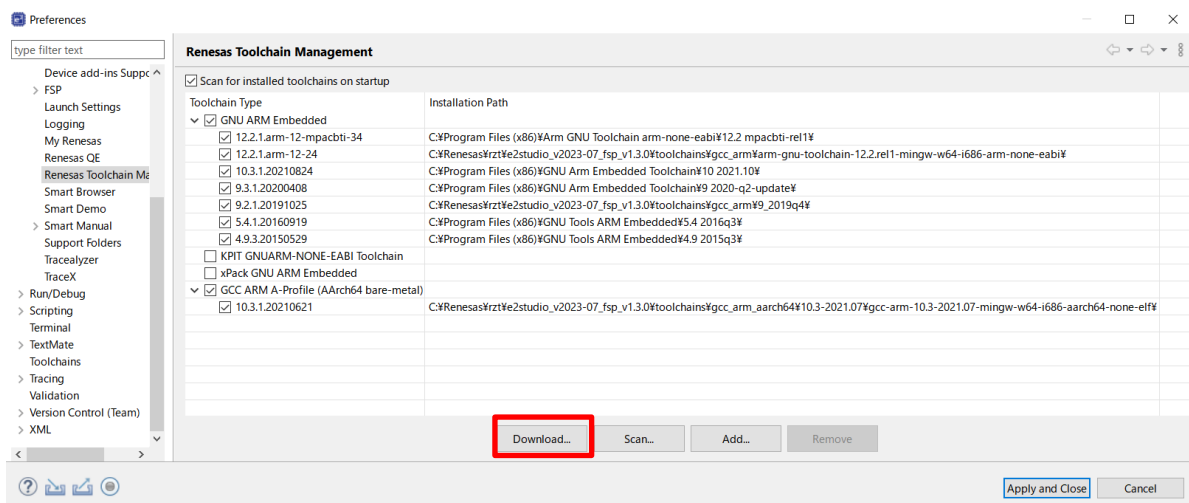

(3) Open “GNU ARM Embedded” tab, select “GNU ARM Embedded 9.3.1”, and click “Finish” button.

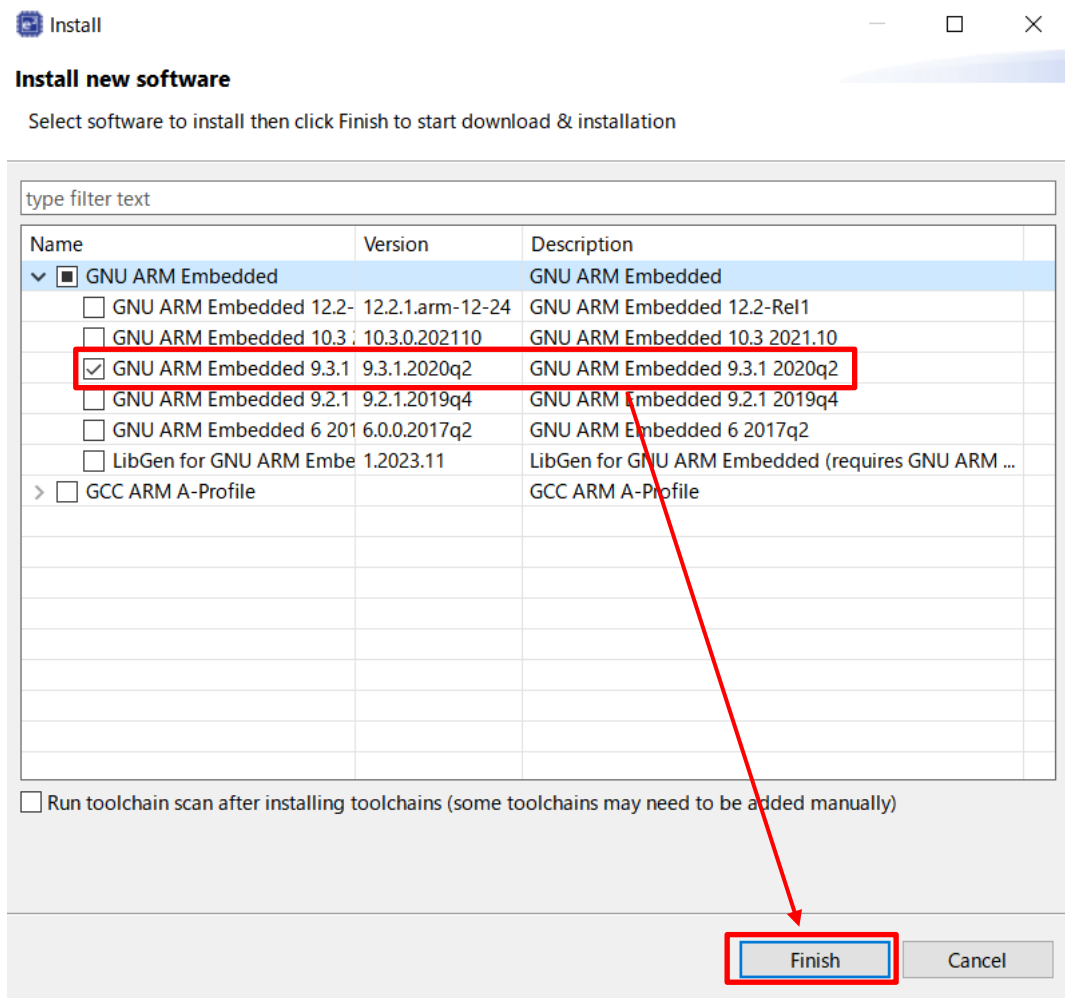

*If you cannot find “GNU ARM Embedded 9.3.1” in the above window, please download “9-2020-q2-update” from the following URL, then restart e² studio and try again.

<https://developer.arm.com/downloads/-/gnu-rm>

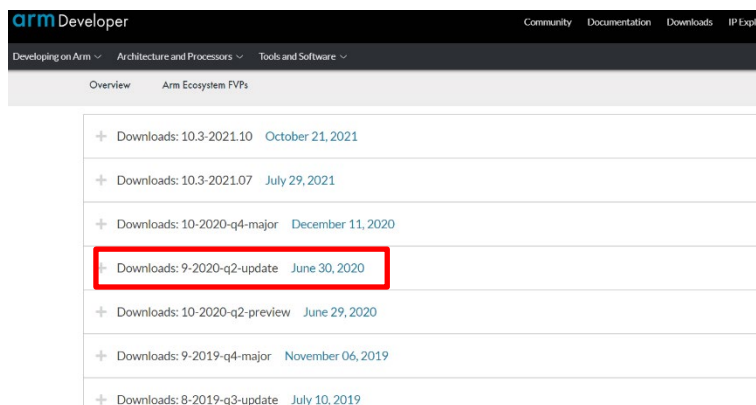

(4) Select language and click “OK” button.

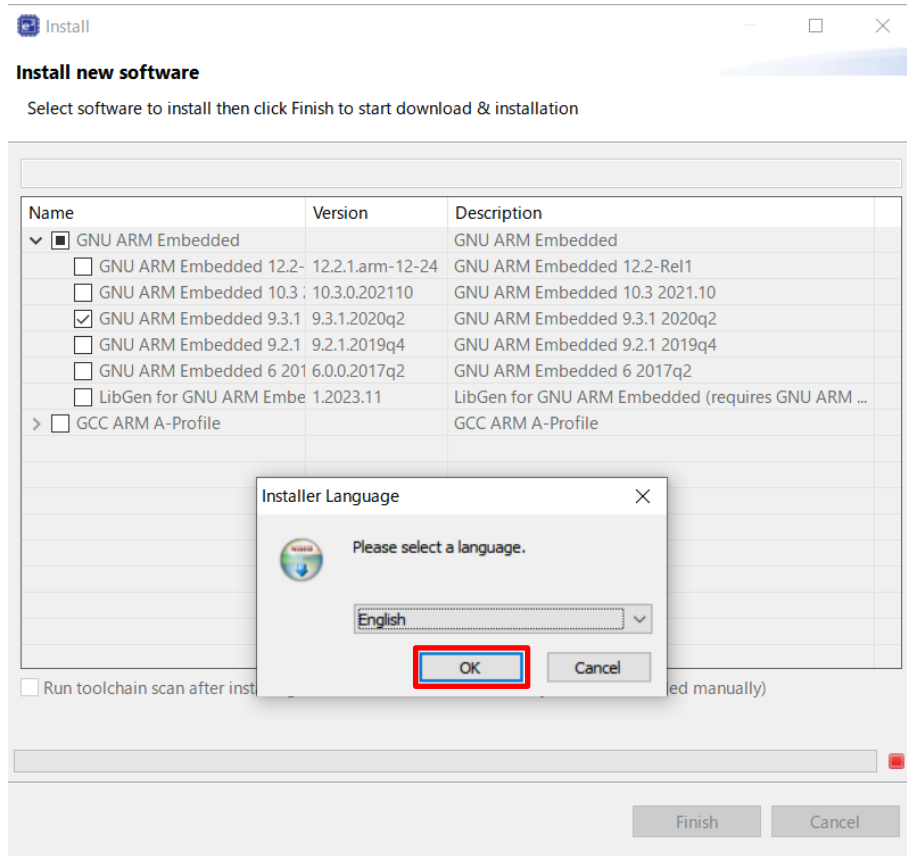

(5) Click “Next” button.

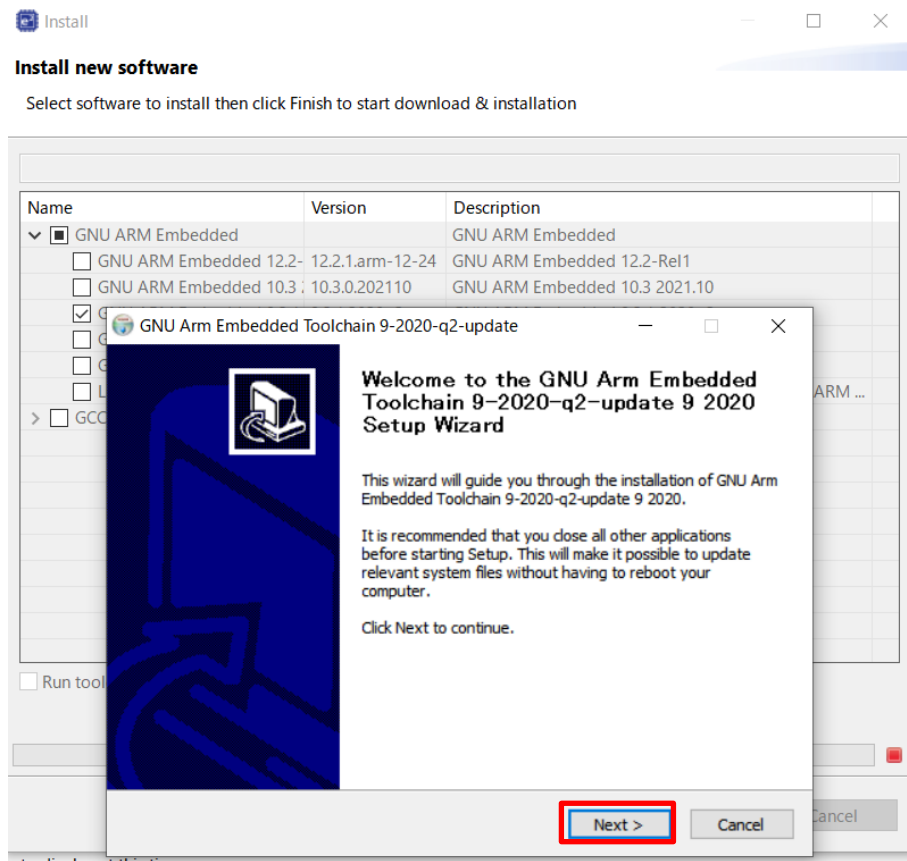

(6) After reading click “I Agree” button.

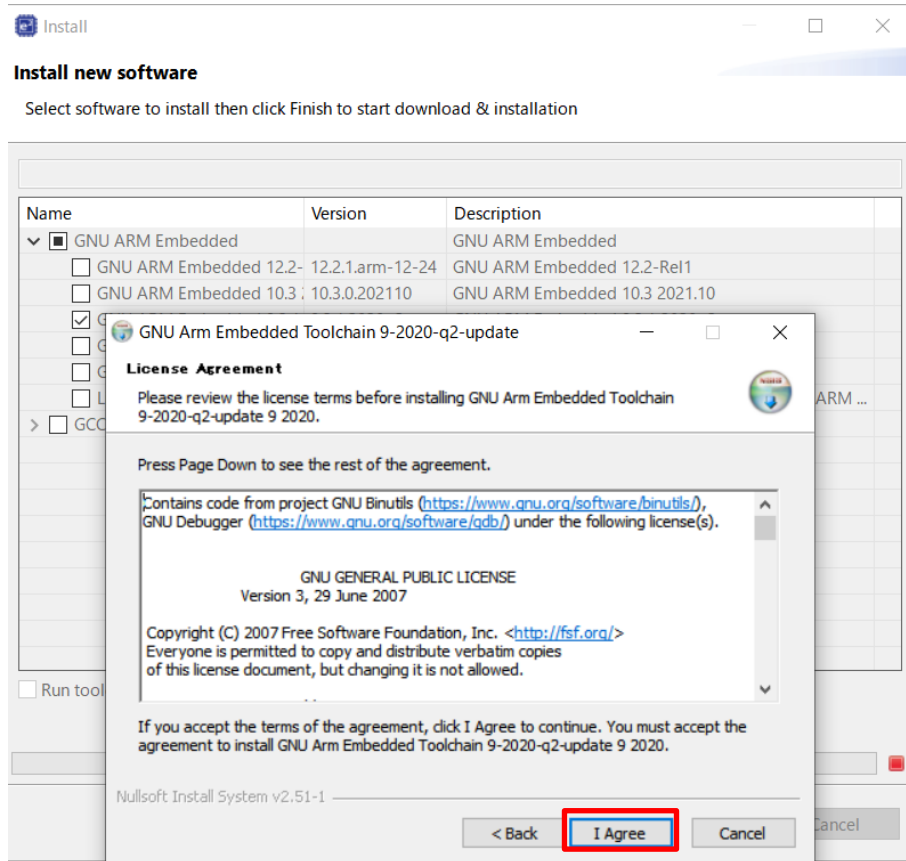

(7) Click “Install” button.

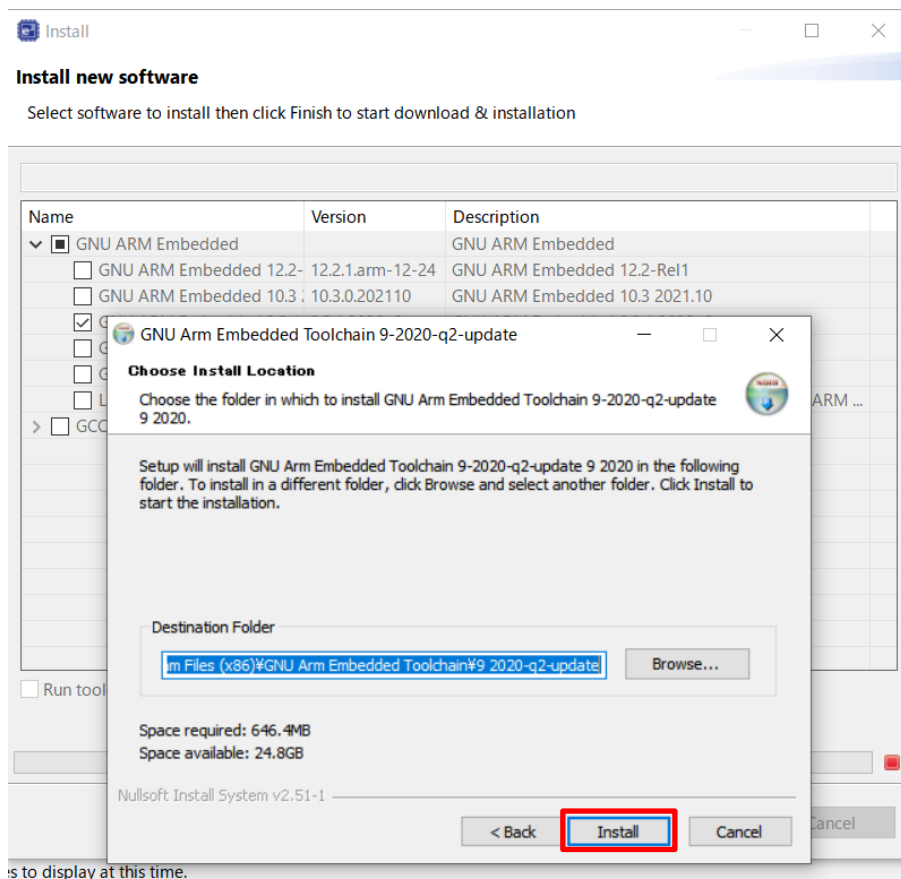

(8) Installation is complete. Click the “Finish” button.

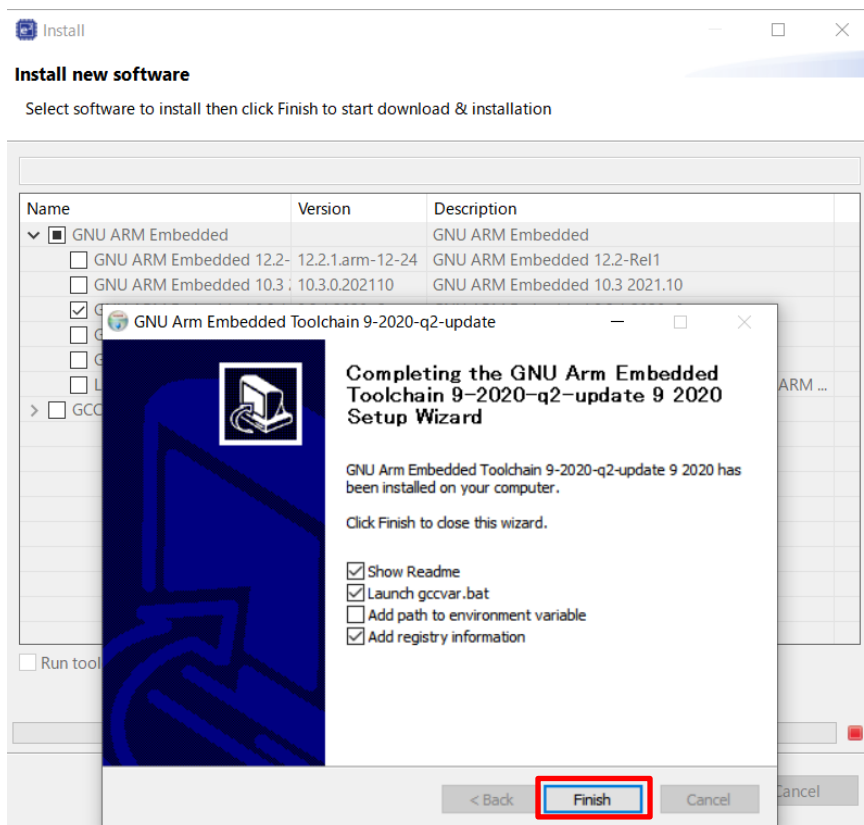

7.3 Program Writing Procedure

This chapter is shown how to write a program to serial Flash ROM.

7.3.1 Power Supply

- ① xSPI0 boot mode setting
Set SW1 of the Controller board to the following.



- ② Power supply to the Inverter board, and then the red lamp lights up. Additionally, the Controller board is supplied 5V DC power from Inverter board and then LED1 lights up.

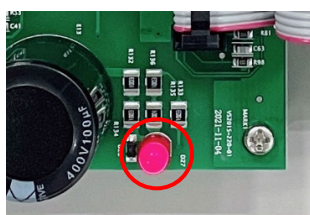

Power lamp of the Inverter board

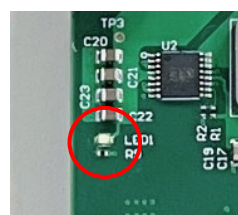

Power LED of the Controller board

7.3.2 EWARM

- ① Select the [All programs] > [IAR EW for Arm x.xx.x] > [IAR EW for Arm x.xx.x] from Windows start menu, start up the IAR Embedded Workbench.

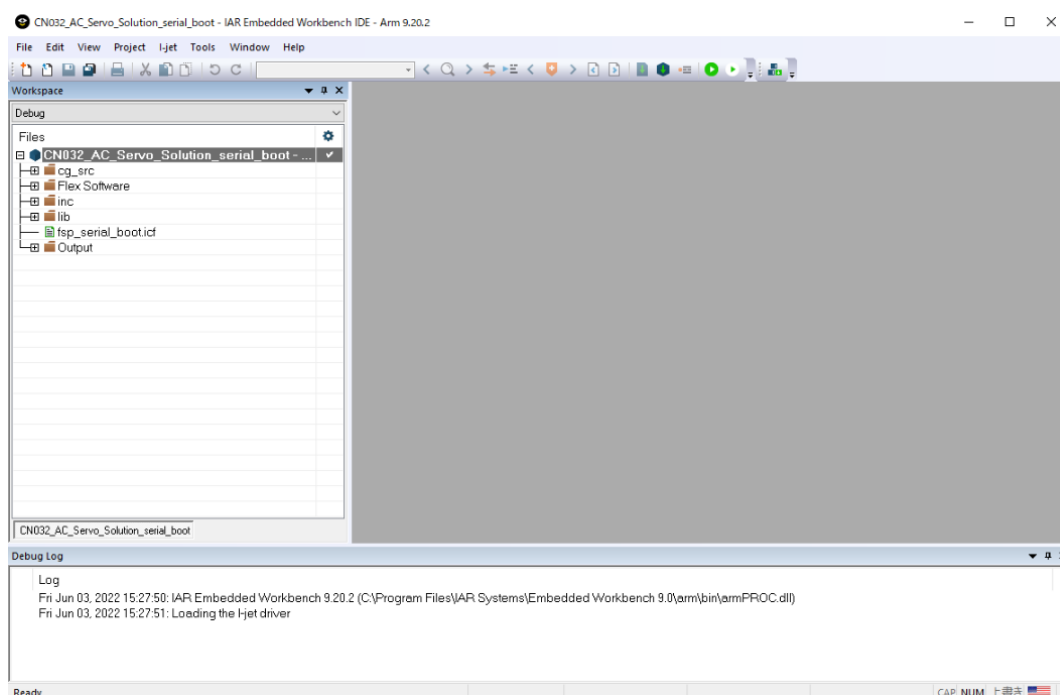

- ② Select the [File] > [Open Workspace...] and select the project file below.
AC Servo Solution Kit (RZ/T2M)

“Software\Firmware\rzt2m\Project\icarm\CPU0_serialboot\CN032_AC_Servo_Solution_CPU0_serialboot.eww”

AC Servo Solution Kit (RZ/T2L)

“Software\Firmware\rzt2l\Project\icarm\serial_boot\CN032_AC_Servo_Solution_serialboot.eww”

AC Servo Solution Kit (RZ/N2L)

“Software\Firmware\rzn2l\Project\icarm\serial_boot\CN032_AC_Servo_Solution_serialboot.eww”

And then open the workspace.

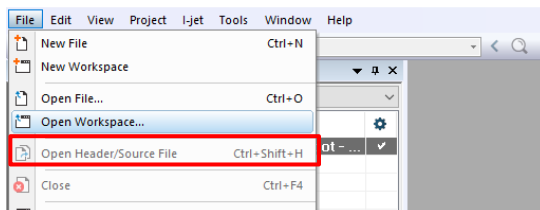

- ③ Execute build. Select [Project] > [Rebuild All].

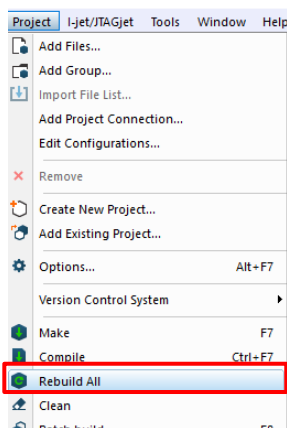

- ④ Select the [Project] > [Download] > [Download active application] to write the program to serial Flash ROM.

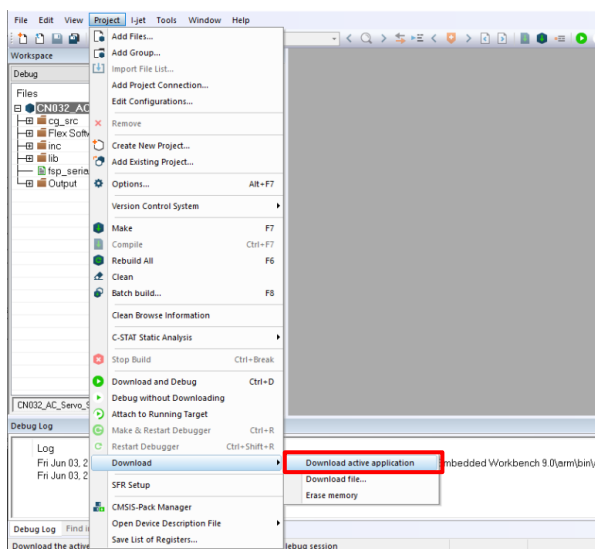

7.3.3 e2studio

- Import the sample project. After the program is started, by selecting [File] → [Import] → [Existing Projects into Workspace]. Check the "select root directory" and select the folder below.

AC Servo Solution Kit (RZ/T2M)

"Software\Firmware\rzt2m\Project\gcc

AC Servo Solution Kit (RZ/T2L)

"Software\Firmware\rzt2l\Project\gcc

AC Servo Solution Kit (RZ/N2L)

"Software\Firmware\rzn2l\Project\gcc

If "Copy projects into workspace" is checked, uncheck it and then selecting [Finish].

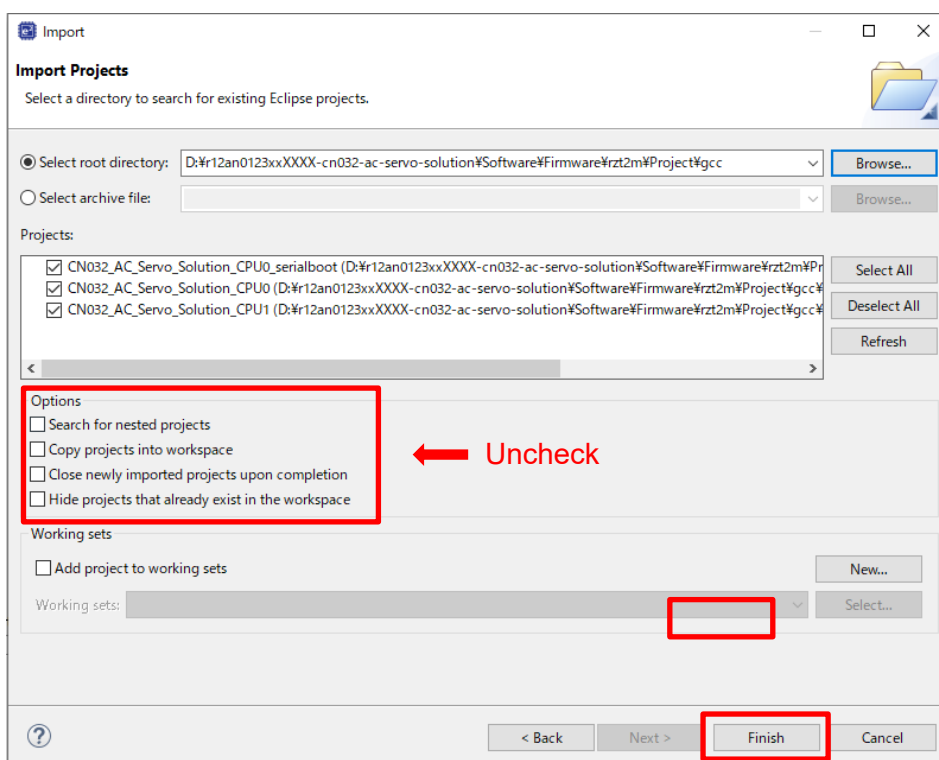

Describe the procedure for AC Servo Solution Kit (RZ/T2M) as example. AC Servo Solution Kit (RZ/T2L, RZ/N2L) can write the program to flash memory using the following procedure.

② Build the “CN032_AC_Servo_Solution_CPU0_serialboot” project

In [Project Explorer] view, right click the node of the project to be debugged and select [Build Project].

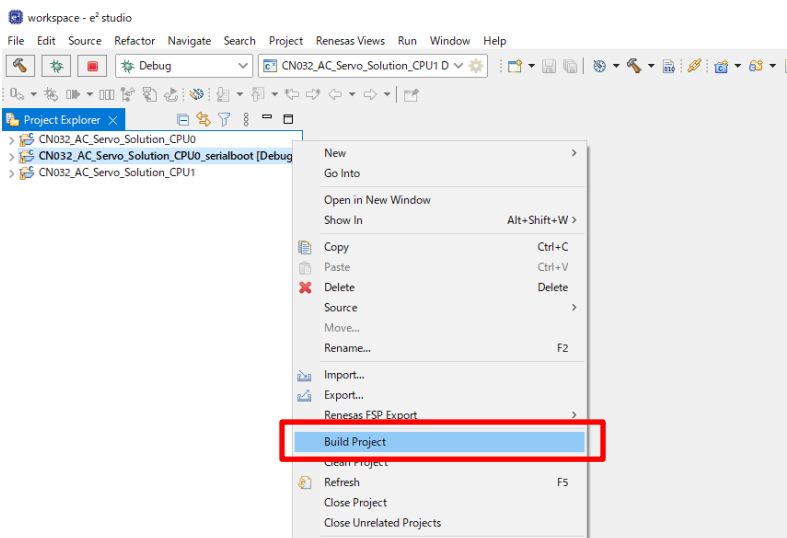

③ Press the “RESET” switch of the Controller board

④ While the board and J-LINK are connected, start writing to the flash memory in the following order
In [Project Explorer] view, right click the node of the CPU0 project to be debugged and select [Debug As] → [Debug Configurations].

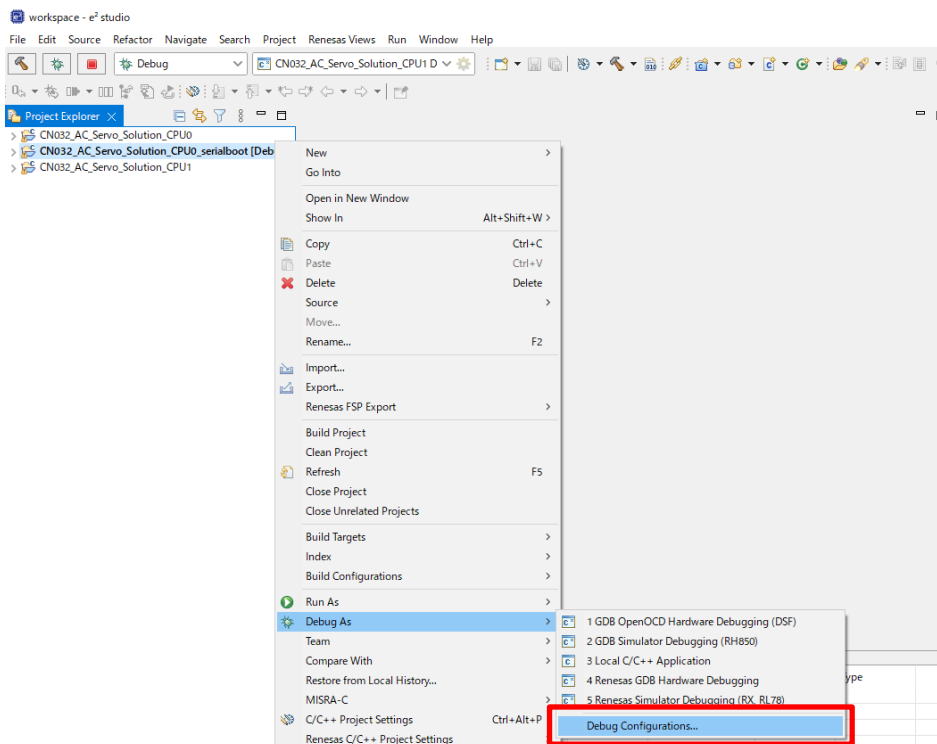

- ⑤ [Renesas DBG Hardware Debugging] → [CN032_AC_Servo_Solution_CPU0_serialboot Debug_Flat] item, then press [Debug].

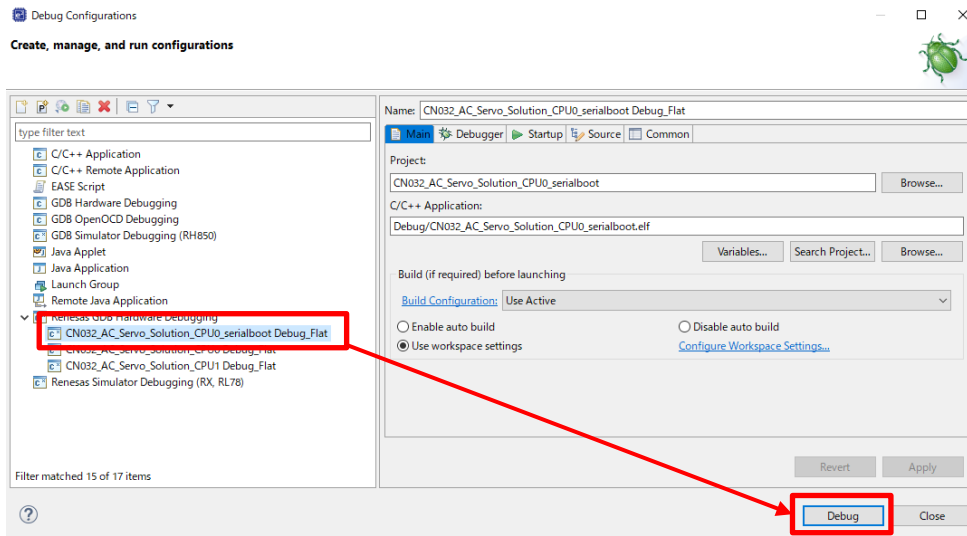

- ⑥ Press the terminate button to stop the debugging window

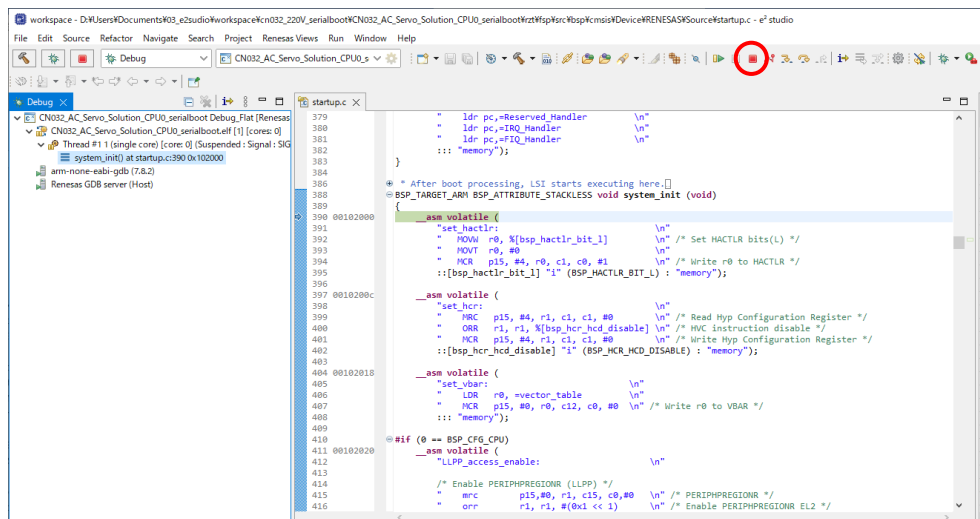

Press the reset button of the Controller board, and then running the program written to the flash memory

Revision History

Rev.	Date	Description	
		Page	Summary
1.00	Jun.8, 2022	-	First Edition issued
2.00	Aug.9, 2022	1,4,8,12, 47,50-52 9,10	Description for AC Servo Solution (RZ/N2L) added. Typo fixed.
3.00	Sep.30, 2022	1 8 47 49,50	Caution when handling the solution board added. RZ/N2L FSP is updated to V1.00. Package folder structure is changed for firmware Rev3.00. File path is changed for firmware Rev3.00.
4.00	Feb.28, 2023	1,4,14,41, 43,45,47, 50,52,53, 59,60 6,7 49	Description for AC Servo Solution (RZ/T2L) added. Description of RS485 communication added. Description of development environment install added.
5.00	Dec.15, 2023	9 11 49	Operating Environment table is updated. Precaution is added. Development Environment install is updated.
5.01	Jun.18,2024	1 4 9 9,10 13 51 58	Related Document updated. Figure 1-1 is updated to the latest AC Servo Solution kit. Operating Environment table is updated. Controller board and inverter board combination added. Connection Configuration is updated to the latest AC Servo Solution kit. 7.2.2Toolchain Install chapter added. Description of import the sample project fixed.

General Precautions in the Handling of Microprocessing Unit and Microcontroller Unit Products

The following usage notes are applicable to all Microprocessing unit and Microcontroller unit products from Renesas. For detailed usage notes on the products covered by this document, refer to the relevant sections of the document as well as any technical updates that have been issued for the products.

1. Precaution against Electrostatic Discharge (ESD)

A strong electrical field, when exposed to a CMOS device, can cause destruction of the gate oxide and ultimately degrade the device operation. Steps must be taken to stop the generation of static electricity as much as possible, and quickly dissipate it when it occurs. Environmental control must be adequate. When it is dry, a humidifier should be used. This is recommended to avoid using insulators that can easily build up static electricity. Semiconductor devices must be stored and transported in an anti-static container, static shielding bag or conductive material. All test and measurement tools including work benches and floors must be grounded. The operator must also be grounded using a wrist strap. Semiconductor devices must not be touched with bare hands. Similar precautions must be taken for printed circuit boards with mounted semiconductor devices.

2. Processing at power-on

The state of the product is undefined at the time when power is supplied. The states of internal circuits in the LSI are indeterminate and the states of register settings and pins are undefined at the time when power is supplied. In a finished product where the reset signal is applied to the external reset pin, the states of pins are not guaranteed from the time when power is supplied until the reset process is completed. In a similar way, the states of pins in a product that is reset by an on-chip power-on reset function are not guaranteed from the time when power is supplied until the power reaches the level at which resetting is specified.

3. Input of signal during power-off state

Do not input signals or an I/O pull-up power supply while the device is powered off. The current injection that results from input of such a signal or I/O pull-up power supply may cause malfunction and the abnormal current that passes in the device at this time may cause degradation of internal elements. Follow the guideline for input signal during power-off state as described in your product documentation.

4. Handling of unused pins

Handle unused pins in accordance with the directions given under handling of unused pins in the manual. The input pins of CMOS products are generally in the high-impedance state. In operation with an unused pin in the open-circuit state, extra electromagnetic noise is induced in the vicinity of the LSI, an associated shoot-through current flows internally, and malfunctions occur due to the false recognition of the pin state as an input signal become possible.

5. Clock signals

After applying a reset, only release the reset line after the operating clock signal becomes stable. When switching the clock signal during program execution, wait until the target clock signal is stabilized. When the clock signal is generated with an external resonator or from an external oscillator during a reset, ensure that the reset line is only released after full stabilization of the clock signal. Additionally, when switching to a clock signal produced with an external resonator or by an external oscillator while program execution is in progress, wait until the target clock signal is stable.

6. Voltage application waveform at input pin

Waveform distortion due to input noise or a reflected wave may cause malfunction. If the input of the CMOS device stays in the area between V_{IL} (Max.) and V_{IH} (Min.) due to noise, for example, the device may malfunction. Take care to prevent chattering noise from entering the device when the input level is fixed, and also in the transition period when the input level passes through the area between V_{IL} (Max.) and V_{IH} (Min.).

7. Prohibition of access to reserved addresses

Access to reserved addresses is prohibited. The reserved addresses are provided for possible future expansion of functions. Do not access these addresses as the correct operation of the LSI is not guaranteed.

- Arm and Cortex are registered trademarks of Arm Limited (or its subsidiaries) in the EU and other countries. All rights reserved.
- Ethernet is a registered trademark of Fuji Xerox Co., Ltd.
- IEEE is a registered trademark of the Institute of Electrical and Electronics Engineers Inc
- EtherCAT® is registered trademark and patented technology, licensed by Beckhoff Automation GmbH, Germany.
- A-format is a trademark of the Nikon Corporation.
- Additionally all product names and service names in this document are a trademark or a registered trademark which belongs to the respective owners.

Notice

1. Descriptions of circuits, software and other related information in this document are provided only to illustrate the operation of semiconductor products and application examples. You are fully responsible for the incorporation or any other use of the circuits, software, and information in the design of your product or system. Renesas Electronics disclaims any and all liability for any losses and damages incurred by you or third parties arising from the use of these circuits, software, or information.
2. Renesas Electronics hereby expressly disclaims any warranties against and liability for infringement or any other claims involving patents, copyrights, or other intellectual property rights of third parties, by or arising from the use of Renesas Electronics products or technical information described in this document, including but not limited to, the product data, drawings, charts, programs, algorithms, and application examples.
3. No license, express, implied or otherwise, is granted hereby under any patents, copyrights or other intellectual property rights of Renesas Electronics or others.
4. You shall be responsible for determining what licenses are required from any third parties, and obtaining such licenses for the lawful import, export, manufacture, sales, utilization, distribution or other disposal of any products incorporating Renesas Electronics products, if required.
5. You shall not alter, modify, copy, or reverse engineer any Renesas Electronics product, whether in whole or in part. Renesas Electronics disclaims any and all liability for any losses or damages incurred by you or third parties arising from such alteration, modification, copying or reverse engineering.
6. Renesas Electronics products are classified according to the following two quality grades: "Standard" and "High Quality". The intended applications for each Renesas Electronics product depends on the product's quality grade, as indicated below.
"Standard": Computers; office equipment; communications equipment; test and measurement equipment; audio and visual equipment; home electronic appliances; machine tools; personal electronic equipment; industrial robots; etc.
"High Quality": Transportation equipment (automobiles, trains, ships, etc.); traffic control (traffic lights); large-scale communication equipment; key financial terminal systems; safety control equipment; etc.
Unless expressly designated as a high reliability product or a product for harsh environments in a Renesas Electronics data sheet or other Renesas Electronics document, Renesas Electronics products are not intended or authorized for use in products or systems that may pose a direct threat to human life or bodily injury (artificial life support devices or systems; surgical implantations; etc.), or may cause serious property damage (space system; undersea repeaters; nuclear power control systems; aircraft control systems; key plant systems; military equipment; etc.). Renesas Electronics disclaims any and all liability for any damages or losses incurred by you or any third parties arising from the use of any Renesas Electronics product that is inconsistent with any Renesas Electronics data sheet, user's manual or other Renesas Electronics document.
7. No semiconductor product is absolutely secure. Notwithstanding any security measures or features that may be implemented in Renesas Electronics hardware or software products, Renesas Electronics shall have absolutely no liability arising out of any vulnerability or security breach, including but not limited to any unauthorized access to or use of a Renesas Electronics product or a system that uses a Renesas Electronics product. RENESAS ELECTRONICS DOES NOT WARRANT OR GUARANTEE THAT RENESAS ELECTRONICS PRODUCTS, OR ANY SYSTEMS CREATED USING RENESAS ELECTRONICS PRODUCTS WILL BE INVULNERABLE OR FREE FROM CORRUPTION, ATTACK, VIRUSES, INTERFERENCE, HACKING, DATA LOSS OR THEFT, OR OTHER SECURITY INTRUSION ("Vulnerability Issues"). RENESAS ELECTRONICS DISCLAIMS ANY AND ALL RESPONSIBILITY OR LIABILITY ARISING FROM OR RELATED TO ANY VULNERABILITY ISSUES. FURTHERMORE, TO THE EXTENT PERMITTED BY APPLICABLE LAW, RENESAS ELECTRONICS DISCLAIMS ANY AND ALL WARRANTIES, EXPRESS OR IMPLIED, WITH RESPECT TO THIS DOCUMENT AND ANY RELATED OR ACCOMPANYING SOFTWARE OR HARDWARE, INCLUDING BUT NOT LIMITED TO THE IMPLIED WARRANTIES OF MERCHANTABILITY, OR FITNESS FOR A PARTICULAR PURPOSE.
8. When using Renesas Electronics products, refer to the latest product information (data sheets, user's manuals, application notes, "General Notes for Handling and Using Semiconductor Devices" in the reliability handbook, etc.), and ensure that usage conditions are within the ranges specified by Renesas Electronics with respect to maximum ratings, operating power supply voltage range, heat dissipation characteristics, installation, etc. Renesas Electronics disclaims any and all liability for any malfunctions, failure or accident arising out of the use of Renesas Electronics products outside of such specified ranges.
9. Although Renesas Electronics endeavors to improve the quality and reliability of Renesas Electronics products, semiconductor products have specific characteristics, such as the occurrence of failure at a certain rate and malfunctions under certain use conditions. Unless designated as a high reliability product or a product for harsh environments in a Renesas Electronics data sheet or other Renesas Electronics document, Renesas Electronics products are not subject to radiation resistance design. You are responsible for implementing safety measures to guard against the possibility of bodily injury, injury or damage caused by fire, and/or danger to the public in the event of a failure or malfunction of Renesas Electronics products, such as safety design for hardware and software, including but not limited to redundancy, fire control and malfunction prevention, appropriate treatment for aging degradation or any other appropriate measures. Because the evaluation of microcomputer software alone is very difficult and impractical, you are responsible for evaluating the safety of the final products or systems manufactured by you.
10. Please contact a Renesas Electronics sales office for details as to environmental matters such as the environmental compatibility of each Renesas Electronics product. You are responsible for carefully and sufficiently investigating applicable laws and regulations that regulate the inclusion or use of controlled substances, including without limitation, the EU RoHS Directive, and using Renesas Electronics products in compliance with all these applicable laws and regulations. Renesas Electronics disclaims any and all liability for damages or losses occurring as a result of your noncompliance with applicable laws and regulations.
11. Renesas Electronics products and technologies shall not be used for or incorporated into any products or systems whose manufacture, use, or sale is prohibited under any applicable domestic or foreign laws or regulations. You shall comply with any applicable export control laws and regulations promulgated and administered by the governments of any countries asserting jurisdiction over the parties or transactions.
12. It is the responsibility of the buyer or distributor of Renesas Electronics products, or any other party who distributes, disposes of, or otherwise sells or transfers the product to a third party, to notify such third party in advance of the contents and conditions set forth in this document.
13. This document shall not be reprinted, reproduced or duplicated in any form, in whole or in part, without prior written consent of Renesas Electronics.
14. Please contact a Renesas Electronics sales office if you have any questions regarding the information contained in this document or Renesas Electronics products.

(Note1) "Renesas Electronics" as used in this document means Renesas Electronics Corporation and also includes its directly or indirectly controlled subsidiaries.

(Note2) "Renesas Electronics product(s)" means any product developed or manufactured by or for Renesas Electronics.

(Rev.5.0-1 October 2020)

Corporate Headquarters

TOYOSU FORESIA, 3-2-24 Toyosu,
Koto-ku, Tokyo 135-0061, Japan
www.renesas.com

Trademarks

Renesas and the Renesas logo are trademarks of Renesas Electronics Corporation. All trademarks and registered trademarks are the property of their respective owners.

Contact information

For further information on a product, technology, the most up-to-date version of a document, or your nearest sales office, please visit:
www.renesas.com/contact/.