

ISL70244SEH

Single Event Effects (SEE) Testing

AN1961
Rev.2.00
Jul 7, 2020

Introduction

The intense proton and heavy ion environment encountered in space applications can cause a variety of single event effects in electronic circuitry, including Single Event Upset (SEU), Single Event Transient (SET), Single Event Functional Interrupt (SEFI), and Single Event Burnout (SEB). SEE can lead to system-level performance issues including disruption, degradation, and destruction. For predictable and reliable space system operation, individual electronic components should be characterized to determine their SEE response. This report discusses the results of SEE testing performed on the ISL70244SEH dual operational amplifier.

Although this report is written for the ISL70244SEH, it applies equally to the ISL73244SEH as it is of the same design and silicon, differing only in radiation assurance testing.

Throughout this document, reference is made to Linear Energy Transfer (LET) and the units of this parameter is always understood to be $\text{MeV} \cdot \text{cm}^2/\text{mg}$.

Product Description

The ISL70244SEH is a dual version of the ISL70444SEH quad operational amplifier and is fabricated in the Renesas PR40 precision bipolar analog process. The die has only two operational amplifiers on it and is not the same die as the ISL70444SEH, but the amplifier design is the same.

Related Literature

For a full list of related documents, visit our website:

- [ISL70244SEH](#), [ISL73244SEH](#) product pages

SEE Test Objectives

The ISL70244SEH was tested to determine its susceptibility to Single Event Burnout (SEB, destructive ion effects) and to characterize its Single Event Transient (SET) behavior over different operating conditions and at several LET levels.

SEE Test Facility

Testing was performed at the Texas A&M University (TAMU) Cyclotron Institute heavy ion facility. This facility is coupled to a K500 super-conducting cyclotron, which is capable of generating a wide range of particle beams with the various energy, flux, and fluence levels needed for advanced radiation testing.

SEE Test Set-Up

SEE testing is carried out with the sample in an active mode configuration. A schematic of the ISL70244SEH SEE test fixture is shown in [Figure 1](#). Four ISL70244SEHs were mounted on a board so as to allow simultaneous heavy ion irradiation of all four units. For SEB, the sum of the four ISL70244SEH supply currents were monitored before, during, and after each irradiation to look for changes in supply current indicating damage. In addition, the two outputs were summed through a non-irradiated amplifier and the result was monitored before and after irradiation for SEB. For SET, the two summed outputs of each ISL70244SEH were used to provide a trigger signal for an oscilloscope that captured and stored both individual ISL70244SEH amplifier outputs. In this way, four oscilloscopes were able to monitor and capture SET in all eight channels of the four dual operational amplifiers under test.

Four copies of the schematic in [Figure 1](#) were placed on one board with the ISL70244SEH parts to allow all four to be irradiated at one time in the beam. The extra amplifier (out of beam) in the upper right of the schematic, sums the dual amplifier outputs of the ISL70244SEH to produce a trigger signal for the oscilloscope so any SET on the part would be captured.

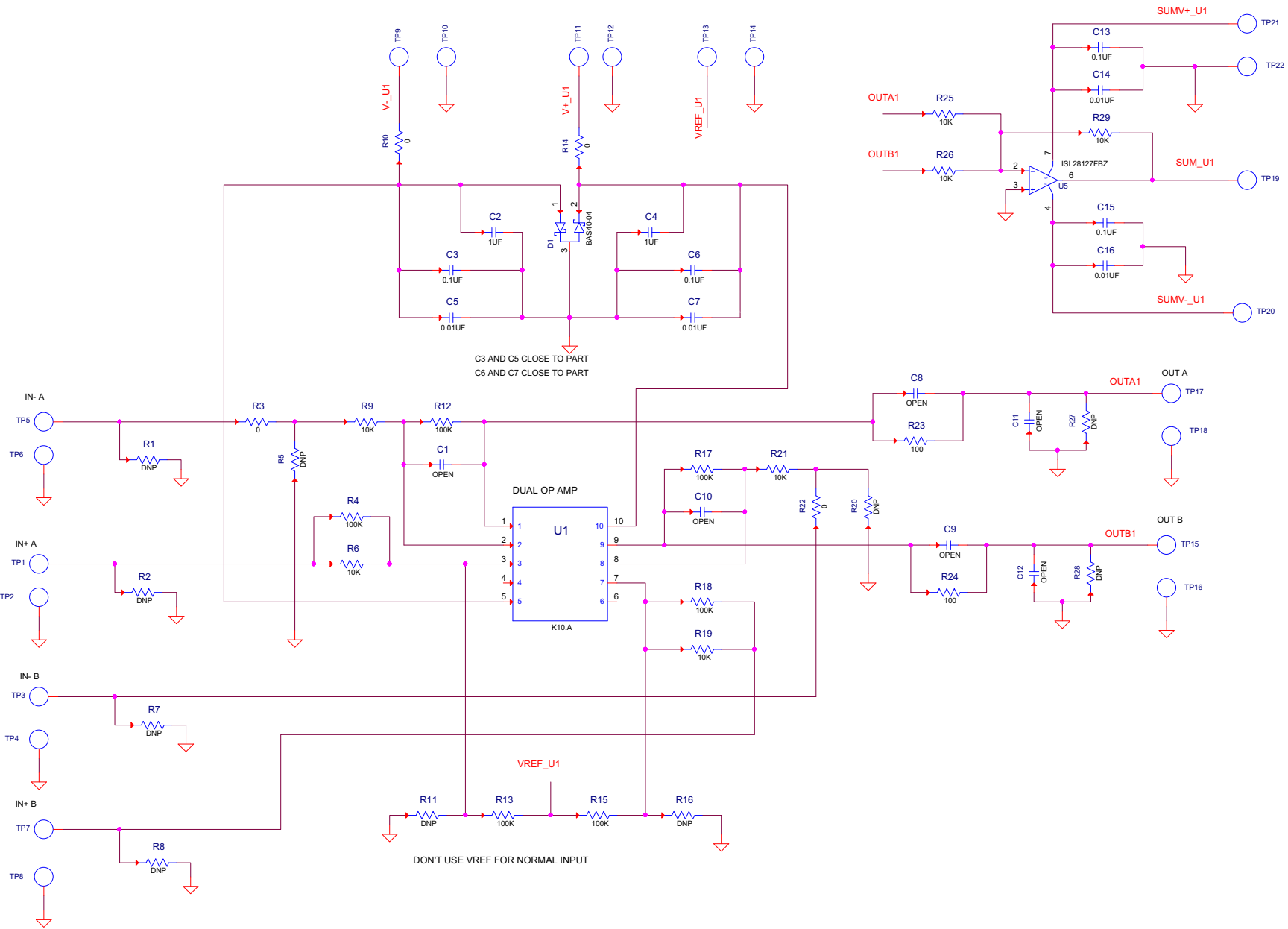

FIGURE 1. ISL70244SEH SEE TEST CIRCUITS BOARD SCHEMATIC

ISL70244SEH SEB Testing

Four units on a single board were irradiated at once with the summed supply currents and the summed dual outputs of each unit were monitored pre and post irradiation. Significant changes in output or supply current were deemed indications of permanent damage caused by the combination of voltage stress and ion impact. The supply voltage was varied to identify the limit when combined with ions of LET = 86MeV • cm²/mg. As reported in [Table 1](#), the four parts survived ±19V and three failed at ±20V under irradiation.

ISL70244SEH SET Testing

For SET, the parts were tested four at a time as in the SEB testing. The dual amplifiers of each device were summed through another (non-irradiated) amplifier to provide an oscilloscope trigger signal if either operational amplifier under irradiation experienced an SET. The individual channels were captured on two other oscilloscope channels. The scope traces were captured and stored for later post processing.

[Table 2](#) summarizes the SET testing done on the ISL70244SEH. Each irradiation was done to a fluence of 4x10⁶ ion/cm² at a flux of 2x10⁴ ion/(cm²s). Irradiation was done in the sequence from high LET to lowest and the same four devices were used throughout the testing. Oscilloscope triggering was at ±20mV except for entries marked with an asterisk (*, ±50mV) or double asterisk (**, ±100mV). SET testing was carried out at ambient temperature, approximately +25°C.

The marked disparity in captures reflects differences in the oscilloscope trigger levels and times. This makes the ratio of the event counts to the fluence only a lower bound on the effective

cross section represented by the device. Post processing the data for SET that exceeded ±100mV deviation and selecting the largest event counts out of the four units tested for each LET and dividing by the beam fluence yielded the lower bounds for ±100mV SET cross sections as depicted in [Figure 2](#). Because the post process to ±100mV captures were done on each amplifier separately, [Figure 2](#) represents cross sections per amplifier. As can be seen, there is considerable noise in the data and it should be taken only as an indicator of cross section, not an accurate measurement.

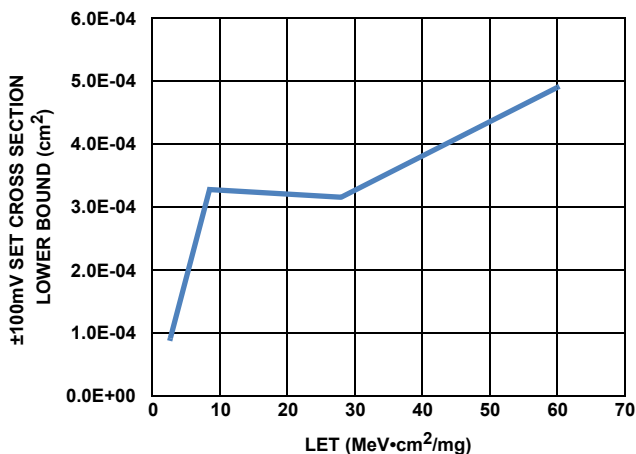

FIGURE 2. CROSS SECTION LOWER BOUND OF ±100mV DEVIATION SET vs LET PER AMPLIFIER

TABLE 1. SUMMARY OF SEB TESTING OF THE ISL70244SEH. Au (LET = 86MeV • cm²/mg) WAS USED TO 5x10⁶ Ion/cm² FOR EACH IRRADIATION WITH T_{CASE} = +125°C FOR EACH RUN

RUN	DUT	GAIN	V _{IN} (V)	VS± (V)	SUM ICC+ (mA) PRE	SUM ICC+ (mA) POST	SUM ICC- (mA) PRE	SUM ICC- (mA) POST	V _{OUT} SUM (V) PRE	V _{OUT} SUM (V) POST
801	1	1	0.1	±19	18.502	18.501	17.991	17.993	0.19741	0.19762
	2								0.19823	0.19824
	3	10							2.1858	2.1857
	4								2.1983	2.198
802	1	1	0.1	±20	20.618	>100	19.743	>100	0.19744	0.19743
	2								0.19825	3
	3	10							2.1857	13
	4								2.1984	13

TABLE 2. SUMMARY OF THE SET TESTING

RUN	DUT	ION SPECIES AND ANGLE	EFFECTIVE LET MeV·cm ² /mg	GAIN SETTING	V _{IN} (V)	V _{OUT} (V)	V _S (V)	±20mV A+B CAPTURES (Note 1)	EVENTS/FLUENCE (cm ²)
401	1	Pr∠15°	60.0	1	0	0	±1.5	5390	1.3E-03
	2							4655	1.2E-03
	3			10				1426	3.6E-04
	4							1982	5.0E-04
402	1	Pr∠15°	60.0	1	0	0	±18	4636	1.2E-03
	2							3840	9.6E-04
	3			10				1006	2.5E-04
	4							1654	4.1E-04
301	1	Kr∠0°	28.0	1	0	0	±1.5	42**	1.1E-05
	2							2677	6.7E-04
	3			10				1130	2.8E-04
	4							2378	5.9E-04
302	1	Kr∠0°	28.0	1	0	0	18	1140**	2.9E-04
	2							2790*	7.0E-04
	3			10				1098**	2.7E-04
	4							2327**	5.8E-04
201	1	Ar∠0°	8.5	1	0	0	±1.5	20**	5.0E-06
	2							2147	5.4E-04
	3			10				1008	2.5E-04
	4							2009	5.0E-04
202	1	Ar∠0°	8.5	1	0	0	±18	94**	2.4E-05
	2							1479	3.7E-04
	3			10				1787	4.5E-04
	4							3188	8.0E-04
101	1	Ne∠0°	2.7	1	0	0	±1.5	8**	2.0E-06
	2							112	2.8E-05
	3			10				471	1.2E-04
	4							938	2.3E-04
102	1	Ne∠0°	2.7	1	0	0	±18	5**	1.3E-06
	2							109	2.7E-05
	3			10				475	1.2E-04
	4							899	2.2E-04

NOTE:

- Oscilloscope triggering was at ±20mV except for entries marked with an asterisk (*, ±50mV) or double asterisk (**, ±100mV).

Figure 3 shows a plot of the SET duration outside $\pm 100\text{mV}$ vs the extreme deviation for the case of $G = 1$, $V_S = \pm 1.5\text{V}$, and $\text{LET} = 60$. This provides a quick way of categorizing the SET by magnitude and duration. All SET captured in Figure 3 had durations of less than $3\mu\text{s}$ outside of the $\pm 100\text{mV}$ window centered on the nominal amplifier output. The deviations are constrained by the supply rails of $\pm 1.5\text{V}$ for this rail-to-rail amplifier. The SET's group into distinct types as can be seen in the plot. The longest events appear in the upper center of Figure 3 and have deviations in the $+300\text{mV}$ range and duration of approximately $2\mu\text{s}$ outside the $\pm 100\text{mV}$ window. This particular type of SET (17 out of 1960 in 4×10^6 ions/ cm^2) is plotted as a composite in Figure 4. Although the total time outside the $\pm 100\text{mV}$ window was approximately $2\mu\text{s}$, the

composite plot indicates the total SET durations were out to about $4\mu\text{s}$ before the output returned to its non-SET value.

Figure 5 is a composite plot of the 30 next largest duration SETs captured for the part represented in Figure 3. These SETs appear at both left and right edges of Figure 3, indicating both positive and negative extreme deviations. The total durations of these events are all under $2\mu\text{s}$ except for three events, which appear related to the events of Figure 4.

Figure 6 DUT1/Scope1 channel B run 402 ($G = 1$, $\text{LET} = 60$, $V_S = \pm 18\text{V}$) SET of larger than $\pm 100\text{mV}$ (1568 in 4×10^6 ions/ cm^2) plotted by extreme deviation on the abscissa and by total duration outside of $\pm 100\text{mV}$ on the ordinate.

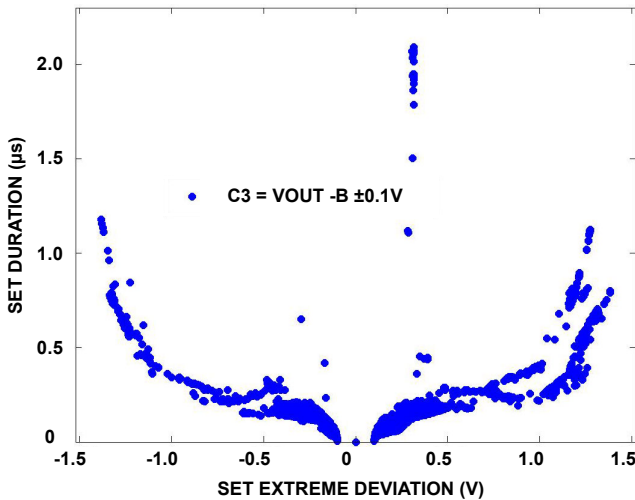

FIGURE 3. DUT1/SCOPE1 CHANNEL B RUN 401 ($G = 1$, $V_S = \pm 1.5\text{V}$, $\text{LET} = 60$) SET OF LARGER THAN $\pm 100\text{mV}$ (1960 in 4×10^6 ions/ cm^2) PLOTTED BY EXTREME DEVIATION ON THE ABSCISSA AND BY TOTAL DURATION OUTSIDE OF $\pm 100\text{mV}$ ON THE ORDINATE

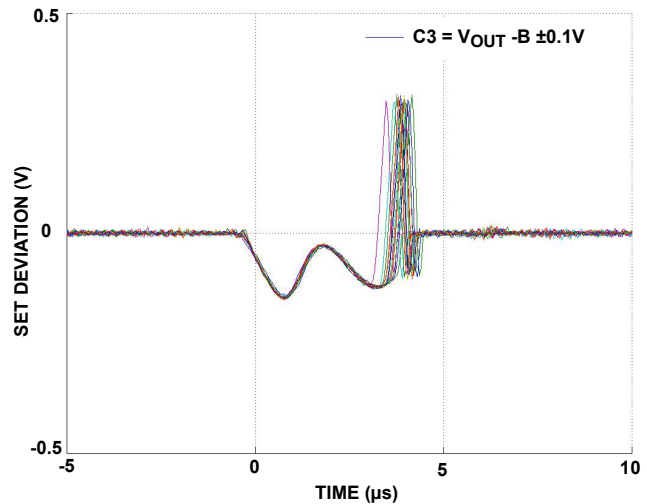

FIGURE 4. COMPOSITE SET PLOTS FOR THE 17 SET IN UPPER CENTER OF Figure 3

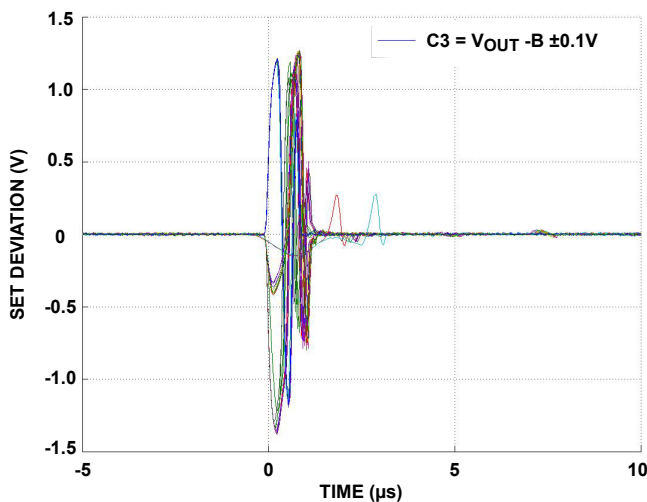

FIGURE 5. THE 30 LONGEST SET FOR DUT1/SCOPE1 CHANNEL B RUN 401 ($G = 1$, $V_S = \pm 1.5$, $\text{LET} = 60$) AFTER THOSE OF Figure 4

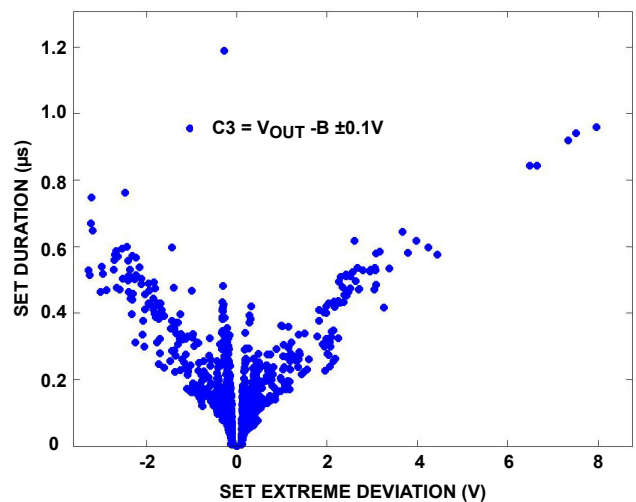

FIGURE 6. DUT1/SCOPE1 CHANNEL B

When the supply rails are taken to $\pm 18V$, the SET are no longer constrained in deviation and exhibit a somewhat different pattern on the deviation versus duration plot as in Figure 6. The central grouping is no longer the longest SET type. A composite of the 30 longest SET events is shown in Figure 7. All of these events, regardless of some large magnitudes, recover within $2\mu s$.

Dropping the LET results in smaller and shorter SET as is indicated in Figure 8 where the SET are resulting from LET = 8.5

Ar ions. The 30 longest SET of those in Figure 8 are plotted in Figure 9. These start with spikes and then recover inside of $2\mu s$.

Dropping to LET = 2.7 (Ne) further reduces the SET's in both deviation and duration as depicted in Figure 10. These SET are little more than spikes with $0.5\mu s$ or less duration outside $\pm 100mV$ deviation.

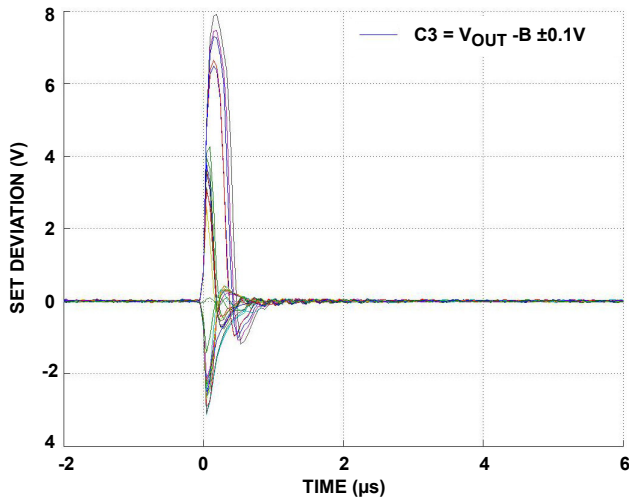

FIGURE 7. COMPOSITE TRACE PLOT OF THE 30 LONGEST DURATION EVENTS OUTSIDE OF $\pm 100mV$ FOR DUT1/SCOPE1 RUN 402 (G = 1, $V_S = \pm 18V$, LET = 60)

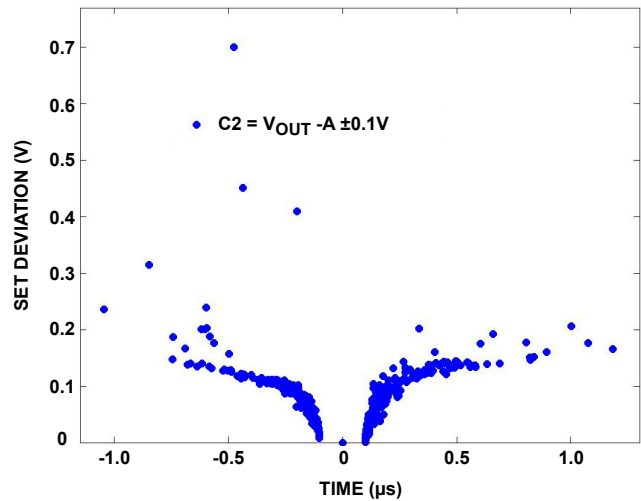

FIGURE 8. DUT2/SCOPE2 CHANNEL A RUN 202 (G = 1, $V_S = \pm 18V$, LET = 8.5) PLOT OF SET OUTSIDE OF $\pm 100mV$ DEVIATION

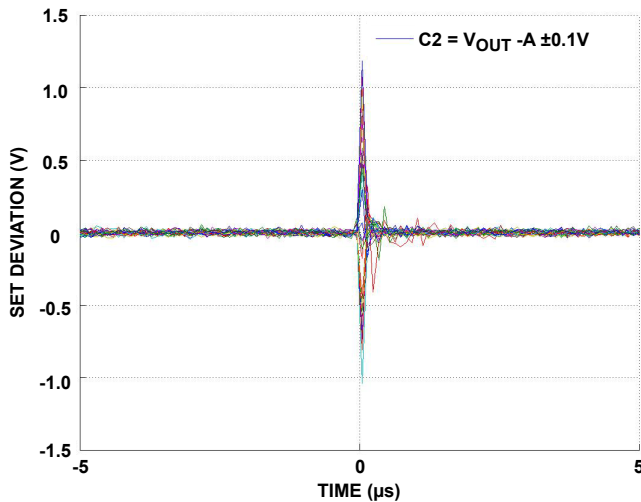

FIGURE 9. 30 LONGEST EVENTS RECORDED FOR DUT2/SCOPE2 CHANNEL A RUN 202 (G = 1, $V_S = \pm 18V$, LET = 8.5)

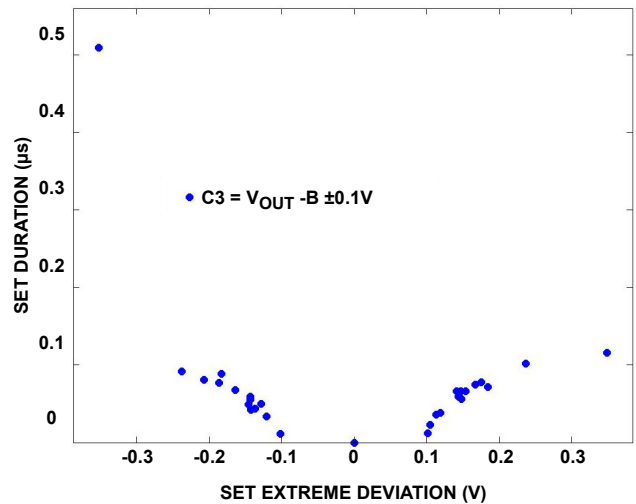

FIGURE 10. DUT1/SCOPE1 CHANNEL B RUN 102 (G = 1, $V_S = \pm 18V$, LET = 2.7) EVENTS BEYOND $\pm 100mV$ (37 IN 4×10^6 IONS/ Cm^2)

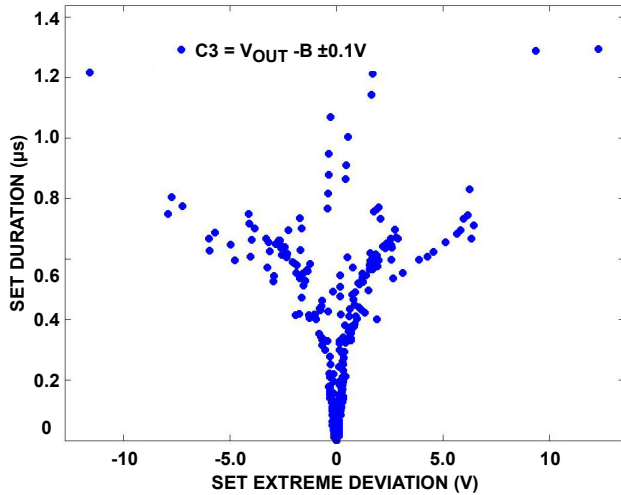

FIGURE 11. DUT3/SCOPE3 CHANNEL B RUN 402 (G = 10, LET = 60, $V_S = \pm 18V$) for SET BEYOND THE $\pm 100mV$ THRESHOLD (478 in 4×10^6 ions/cm²)

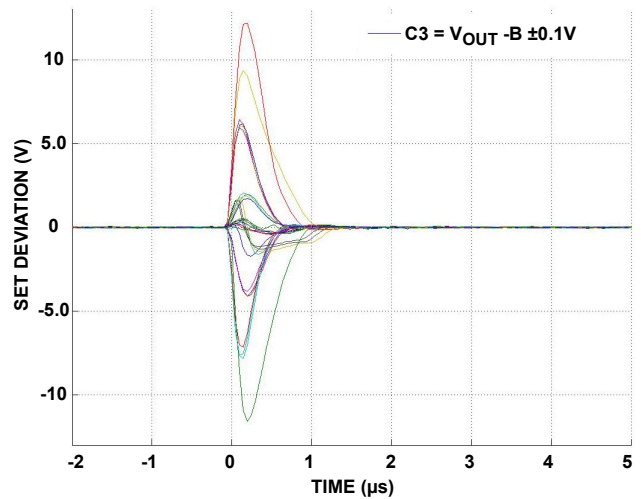

FIGURE 12. THE 30 LONGEST SET TO $\pm 100mV$ FOR DUT3/SCOPE3 CHANNEL B RUN 402 (G = 10, $V_S = \pm 18$, LET = 60)

Changing the amplifier gain from 1 to 10 has minor impact on the SET forms as can be seen in Figure 11, which can be compared to Figure 6. Again the SET durations beyond $\pm 100mV$ are below $2\mu s$ while the deviations can go past $\pm 10V$. The 30 longest SET's are depicted in Figure 12 and all of these SET's are over in less than $2\mu s$.

SET testing at $+25^\circ C$ demonstrated that SET resulting from ions of up to LET = 60 are limited to under $5\mu s$ in duration. The deviation for these SET range from $-12V$ to $+12V$ from a nominal 0V output with supply voltages of $\pm 18V$. These magnitudes as well as the durations decrease with decreasing LET. At LET = 2.7V, the lowest tested, SET are bounded within $\pm 0.4V$ and have durations of less than $1\mu s$.

Conclusions

The ISL70244SEH dual operational amplifier has been shown to be free from permanent damage under irradiation by ions with LET of $86MeV \cdot cm^2/mg$ (normal incidence) up to supply voltages of $\pm 19V$ at $+125^\circ C$ case temperature. At $\pm 20V$ damage was noted.

Revision History

DATE	REVISION	CHANGE
Jul 7, 2020	2.00	Corrected the Effective LET in table 2 for Run 101 and 102.
Nov 7, 2018	1.00	Added second paragraph on page 1. Updated Related Literature section. Added Revision History section. Updated disclaimer.

IMPORTANT NOTICE AND DISCLAIMER

RENESAS ELECTRONICS CORPORATION AND ITS SUBSIDIARIES (“RENESAS”) PROVIDES TECHNICAL SPECIFICATIONS AND RELIABILITY DATA (INCLUDING DATASHEETS), DESIGN RESOURCES (INCLUDING REFERENCE DESIGNS), APPLICATION OR OTHER DESIGN ADVICE, WEB TOOLS, SAFETY INFORMATION, AND OTHER RESOURCES “AS IS” AND WITH ALL FAULTS, AND DISCLAIMS ALL WARRANTIES, EXPRESS OR IMPLIED, INCLUDING, WITHOUT LIMITATION, ANY IMPLIED WARRANTIES OF MERCHANTABILITY, FITNESS FOR A PARTICULAR PURPOSE, OR NON-INFRINGEMENT OF THIRD PARTY INTELLECTUAL PROPERTY RIGHTS.

These resources are intended for developers skilled in the art designing with Renesas products. You are solely responsible for (1) selecting the appropriate products for your application, (2) designing, validating, and testing your application, and (3) ensuring your application meets applicable standards, and any other safety, security, or other requirements. These resources are subject to change without notice. Renesas grants you permission to use these resources only for development of an application that uses Renesas products. Other reproduction or use of these resources is strictly prohibited. No license is granted to any other Renesas intellectual property or to any third party intellectual property. Renesas disclaims responsibility for, and you will fully indemnify Renesas and its representatives against, any claims, damages, costs, losses, or liabilities arising out of your use of these resources. Renesas' products are provided only subject to Renesas' Terms and Conditions of Sale or other applicable terms agreed to in writing. No use of any Renesas resources expands or otherwise alters any applicable warranties or warranty disclaimers for these products.

(Rev.1.0 Mar 2020)

Corporate Headquarters

TOYOSU FORESIA, 3-2-24 Toyosu,
Koto-ku, Tokyo 135-0061, Japan
www.renesas.com

Contact Information

For further information on a product, technology, the most up-to-date version of a document, or your nearest sales office, please visit:
www.renesas.com/contact/

Trademarks

Renesas and the Renesas logo are trademarks of Renesas Electronics Corporation. All trademarks and registered trademarks are the property of their respective owners.