

RA4W1 Group

Voice Recognition Demonstration(AmiVoiceMicro)

Introduction

This application note explains demo operation using EK-RA4W1 which is applied to Bluetooth® Low Energy and HMI expansion board. This demo use AmiVoice® Micro which is a voice recognition library of Advanced Media, Inc. and 'Zoom Voice' which is a beamforming and noise suppressor middleware of Techno Mathematical Co., Ltd..

Target Device

EK-RA4W1 (RTK7EKA4W1S00000BJ)

HMI Expansion Board (RTK0EG001BB00001BJ)

Related Documents

1. RA4W1 Group EK-RA4W1 User's Manual (R20UT4683JJ0100)
2. RA4W1 Group Voice Recognition Sample Software (AmiVoiceMicro) (R11AN0522EJ0100)

AmiVoice®Micro belongs to Advanced Media, Inc.. (Shown as AmiVoice in this document.)
Zoom Voice belongs to Techno Mathematical Co., Ltd.

Contents

1. Outline.....	3
2. Demonstration preparation	4
2.1 Connection	4
2.2 Power supply	4
3. Demonstration instruction	5
3.1 Connection	5
3.2 Screen transition.....	5
3.3 Voice Recognition.....	6
3.3.1 Recognizable direction	6
3.4 Voice Recognition parameter setting	7
3.5 Environmental Sensor information	7
3.6 On-board LED control	8
3.7 Disconnect Bluetooth Low Energy	8
4. Functions.....	9
4.1 Display voice recognition result.....	9
4.2 Recognizable phrase and corresponding operation.....	10
4.3 Voice Recognition Parameter settings	12
Revision History	15

1. Outline

This demonstration is a voice recognition demo which uses EK-RA4W1(RTK7EKA4W1S00000BJ) and HMI Expansion Board (RTK0EG001BB00001BJ). The result of voice recognition is sent to and cooperate with mobile devices via Bluetooth Low Energy.

The HMI Expansion Board is equipped with a microphone, speaker, temperature / humidity sensor (HS3001), and gas sensor (ZMOD4410). Using these, voice recognition, audio playback, and acquisition of each sensor data are possible.

Furthermore, it is possible to communicate with a specific web app using Bluetooth Low Energy, display the result of voice recognition and sensor data on the application, set the parameters of each middleware, and control the LED on the demo board from the application.

Figure 1.1 show how it works.

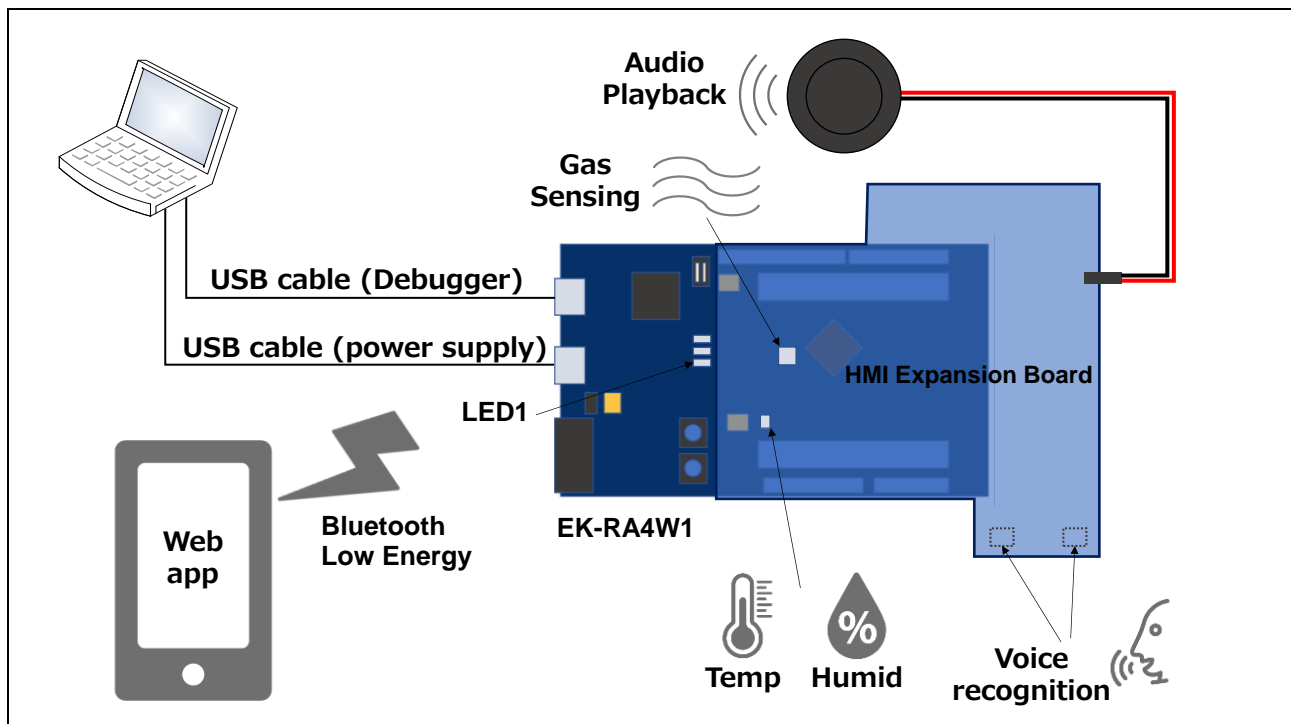

Figure 1.1 Operation image

2. Demonstration preparation

This section explains the preparation of demonstration.

2.1 Connection

Connect Arduino™UNO connector on EK-RA4W1 to HMI Expansion Board.

Connection to the board is shown in figure 2.1.

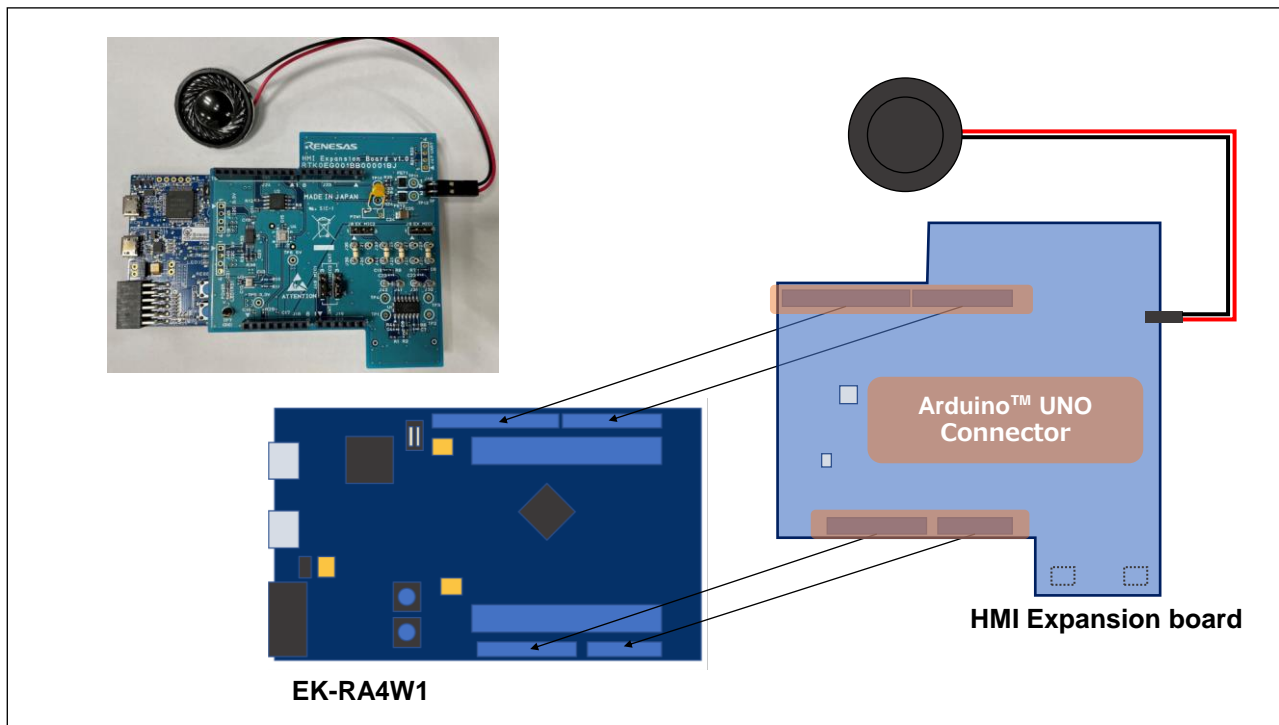

Figure 2.1 Board connection

2.2 Power supply

Power supply of the demo is supplied from USB micro B connector.

USB AC adopter, mobile battery and PC those which can supply 5V are used for power supply.

3. Demonstration instruction

3.1 Connection

How to connect the demo board to Web app is explained in this section. Figure 3.1 shows the example when using Android smart phone.

Connection will start when start Web app and tap 'CONNECT' on the upper right.

When successfully complete connection, 'No Middleware' will change to 'Middleware : AmiVoice' and 'Measurement is started' will show up on the bottom of the screen to start voice recognition.

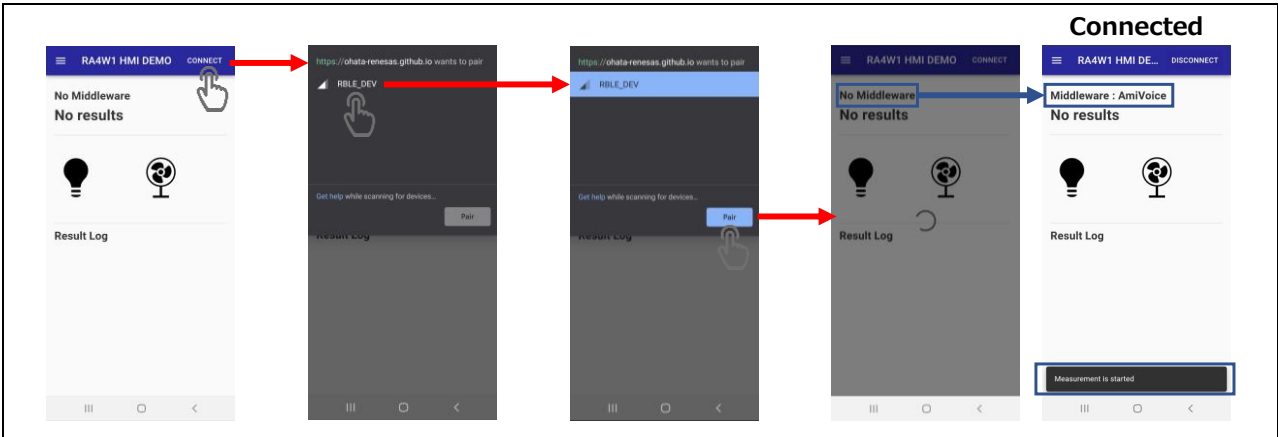

Figure 3.1 Connection

3.2 Screen transition

Figure 3.2 shows screen transition of the Web app. By tapping the icon on the top left, Menu screen will come up. Select each menu to transit to each screen.

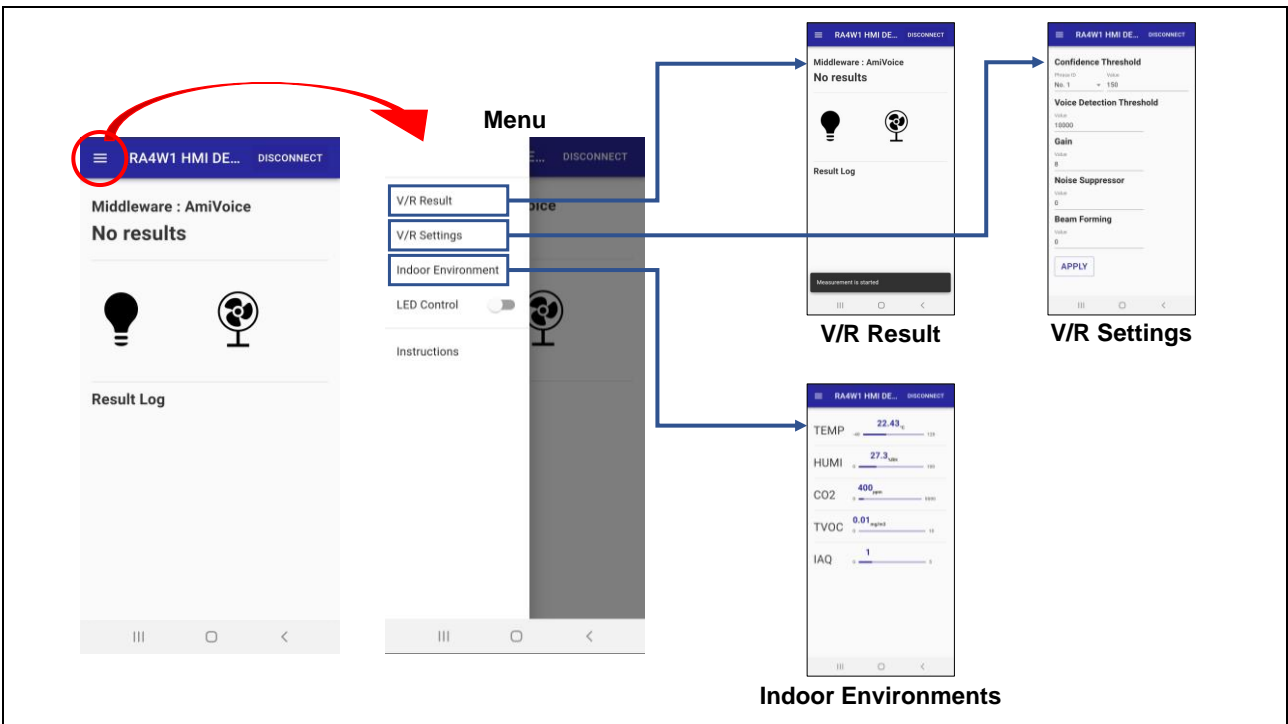

Figure 3.2 Screen Transition

3.3 Voice Recognition

Voice recognition starts by talking to the demo board. Depend on the result of the recognition, voice is feed backed and changes the V/R Result screen on the Web app via Bluetooth Low Energy. Recognizable phrase and operation for each result is described in Chapter 4.

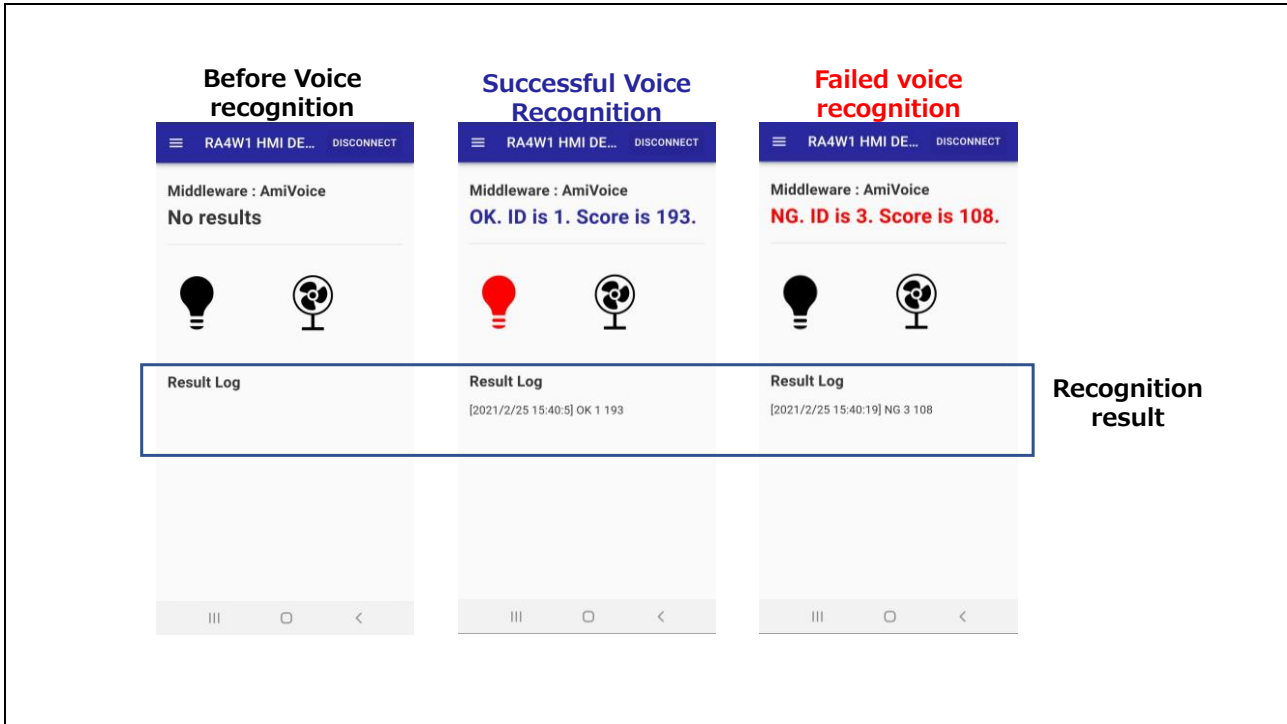

Figure 3.3 V/R Result screen

3.3.1 Recognizable direction

Beamforming is activated when talking to the board from below direction.

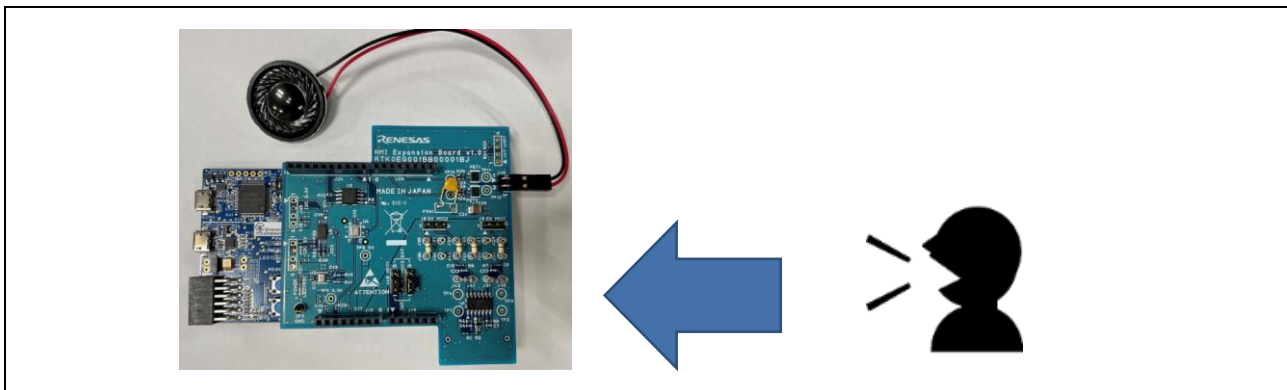

Figure 3.4 Beamforming direction

3.4 Voice Recognition parameter setting

Parameters for voice recognition can be changed from V/R setting screen on the Web app. Refer Chapter 4.3 for detail.

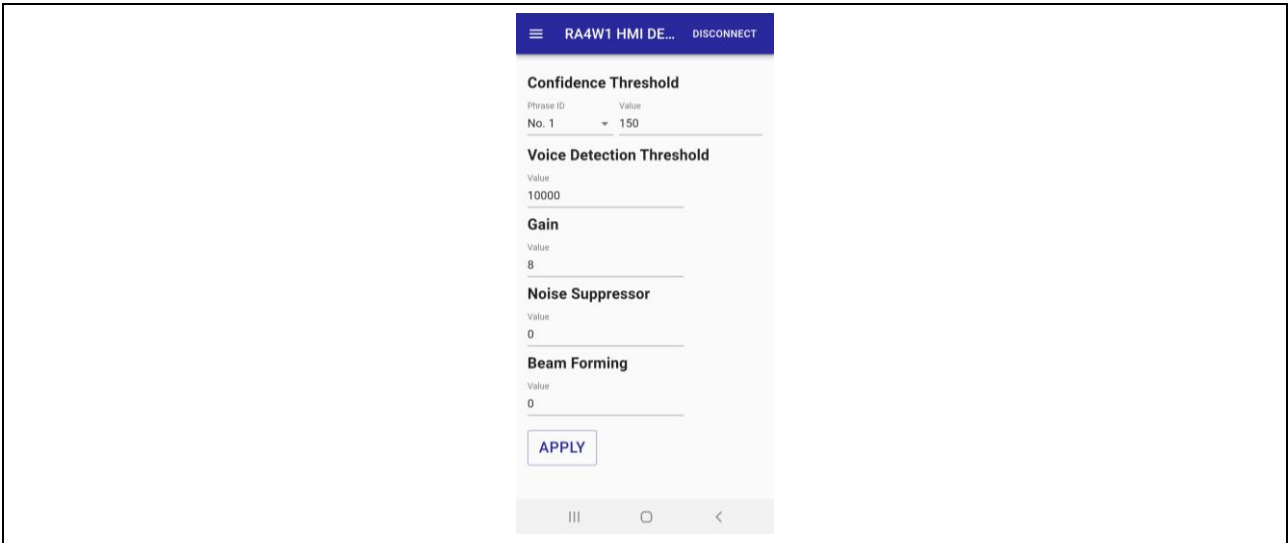

Figure 3.5 V/R setting screen

3.5 Environmental Sensor information

Confirm the sensor information on the Indoor Environment screen on the Web app. Indoor Environment screen display will change according to received sensor information.

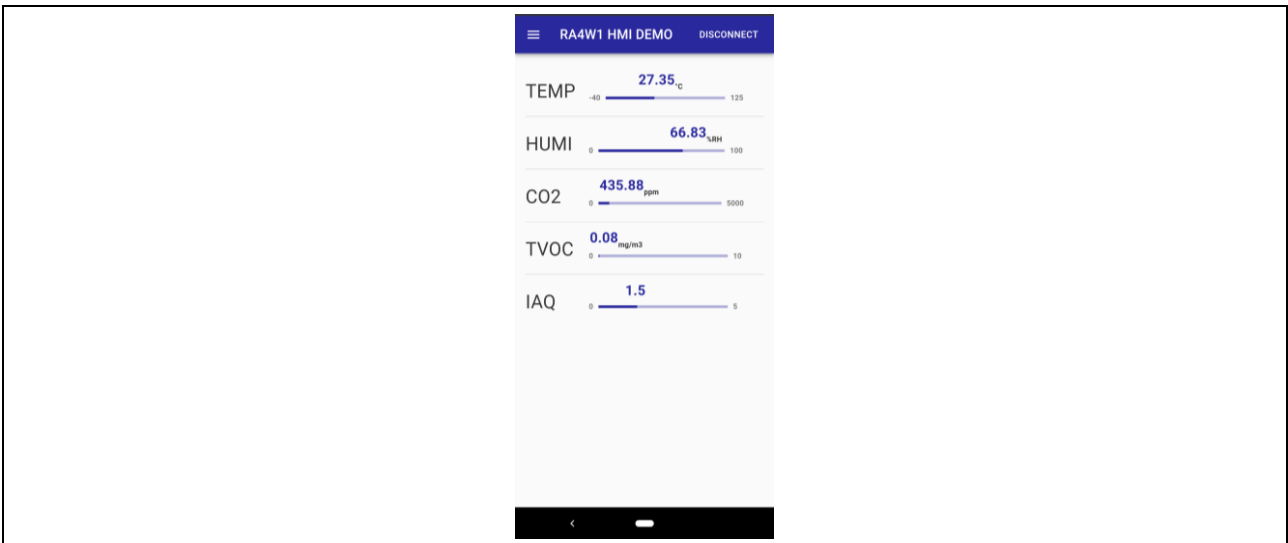

Figure 3.6 Indoor Environment screen

3.6 On-board LED control

Control LED1 on the EK-RA4W1 from the Menu screen. Figure 3.7 shows screen when controlling the LED. By tapping the switch on the screen, LED ON/OFF will be controlled.

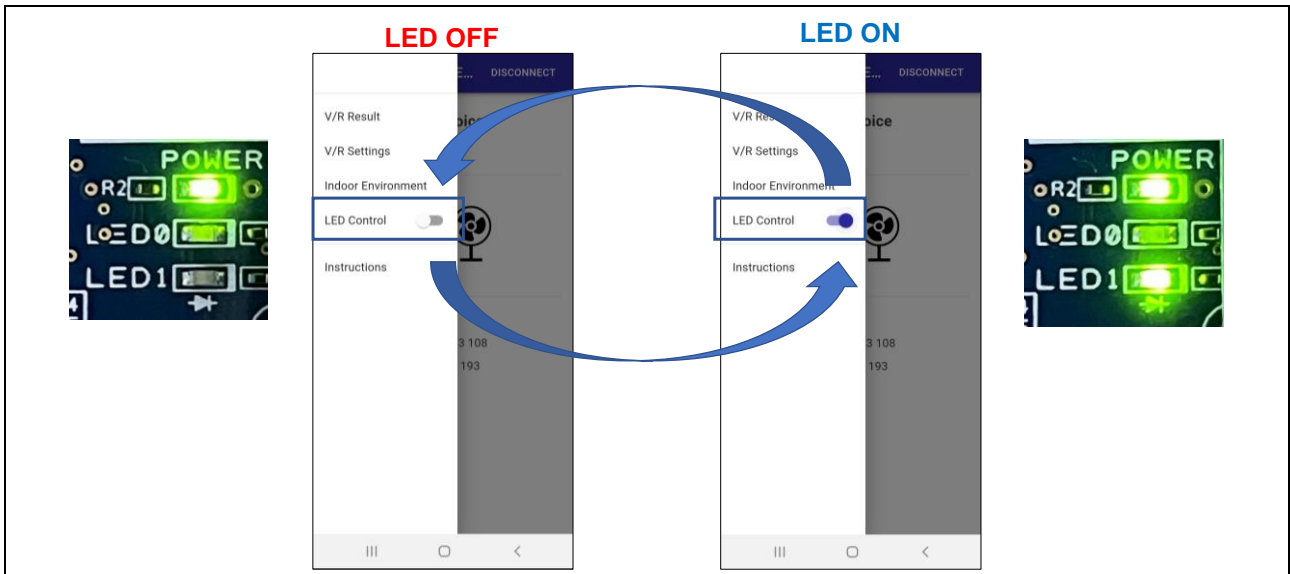

Figure 3.7 LED Control screen

3.7 Disconnect Bluetooth Low Energy

Figure 3.8 shows Bluetooth Low Energy disconnection. Tap 'DISCONNECT' on the upper right to disconnect Bluetooth Low Energy. When disconnection completed, it displays 'The device is disconnected' on the bottom of the screen. Operate along with Figure 3.1 to re-connect Bluetooth Low Energy.

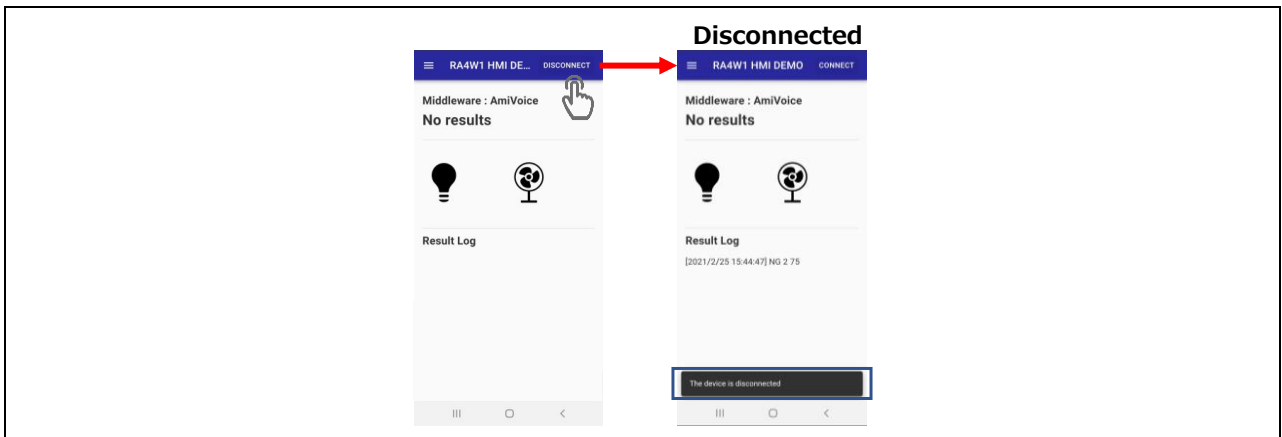

Figure 3.8 Disconnect Bluetooth Low Energy

4. Functions

The functions of this demo are as below.

1. Voice Recognition
2. Audio Feedback
3. Send voice recognition result and sensor information via Bluetooth Low Energy
4. Parameter setting and LED control by Web app

4.1 Display voice recognition result

This demo starts recognizing voice by connecting to Web app. Display of the voice recognition result on the V/R Result screen is shown as Figure 4.1. It judges recognition is succeeded when the phrase threshold is exceeded the Confidence Threshold which is set on the V/R Settings screen. The Confidence Threshold is set to 100 as a default.

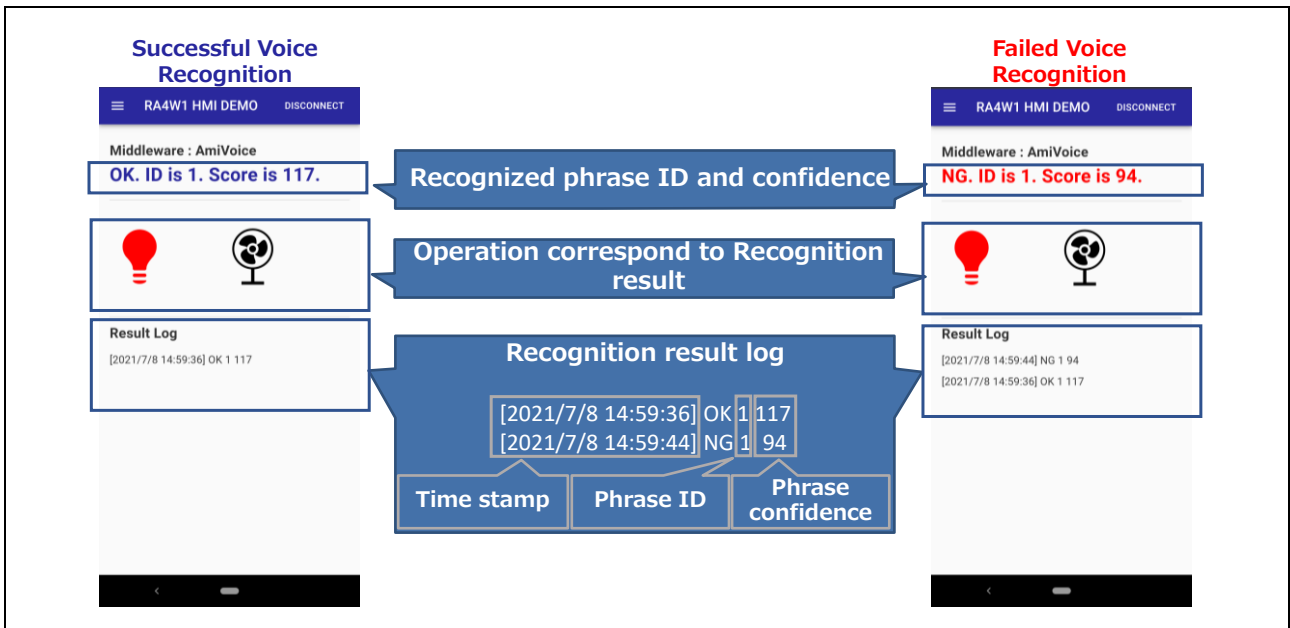
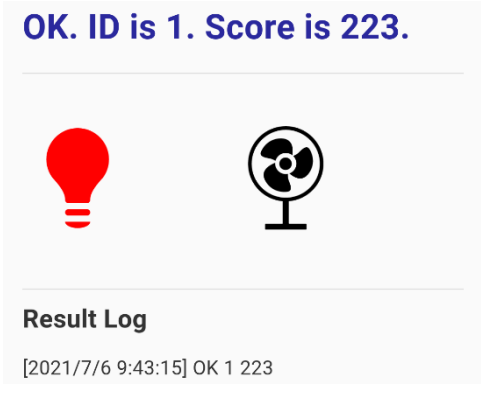
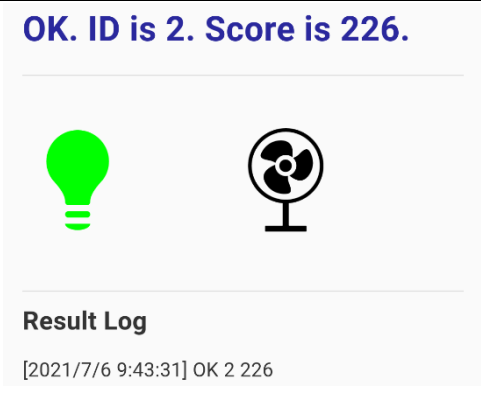
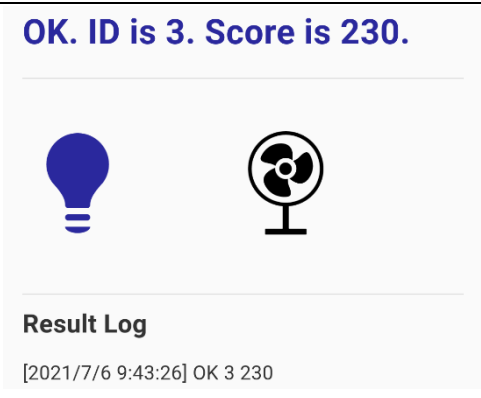









Figure 4.1 Voice recognition result display

4.2 Recognizable phrase and corresponding operation

Table 4.1 shows recognizable phrase, audio feedback corresponds to result of voice recognition and Web app display. When detect voice, LED0 turns ON.

Table 4.1 Recognizable phrase and operation

ID	Phrase	Operation	
		Audio playback	V/R Result screen
1	Red color	Color changed	<p>OK. ID is 1. Score is 223.</p> 
2	Green color	Color changed	<p>OK. ID is 2. Score is 226.</p> 
3	Blue color	Color changed	<p>OK. ID is 3. Score is 230.</p> 

4	Electric fan power	(Sound effect)	<p>OK. ID is 4. Score is 208.</p> <hr/>   <hr/> <p>Result Log [2021/7/6 9:52:25] OK 4 208 (electric fan rotate)</p>
5	Electric fan swing	Mode changed	<p>OK. ID is 5. Score is 197.</p> <hr/>   <hr/> <p>Result Log [2021/7/6 9:52:37] OK 5 197 (electric fan swing)</p>
6	Electric fan high speed	Mode changed	<p>OK. ID is 6. Score is 198.</p> <hr/>   <hr/> <p>Result Log [2021/7/6 9:52:31] OK 6 198 (electric fan rotate faster)</p>
7	Electric fan low speed	Mode changed	<p>OK. ID is 7. Score is 186.</p> <hr/>   <hr/> <p>Result Log [2021/7/6 9:52:42] OK 7 186 (electric fan rotate slower)</p>

4.3 Voice Recognition Parameter settings

Parameters for voice recognition can be set from V/R Settings screen via Bluetooth Low Energy. Parameters and setting instruction are described below.

- Confidence Threshold

Confidence Threshold of AmiVoice can be set from 0 to 255 per each phrase. Select phrase ID to be set from 'Phrase ID' and input the value to 'Value.' Select 'APPLY' to reflect the setting to the demo board via Bluetooth Low Energy.

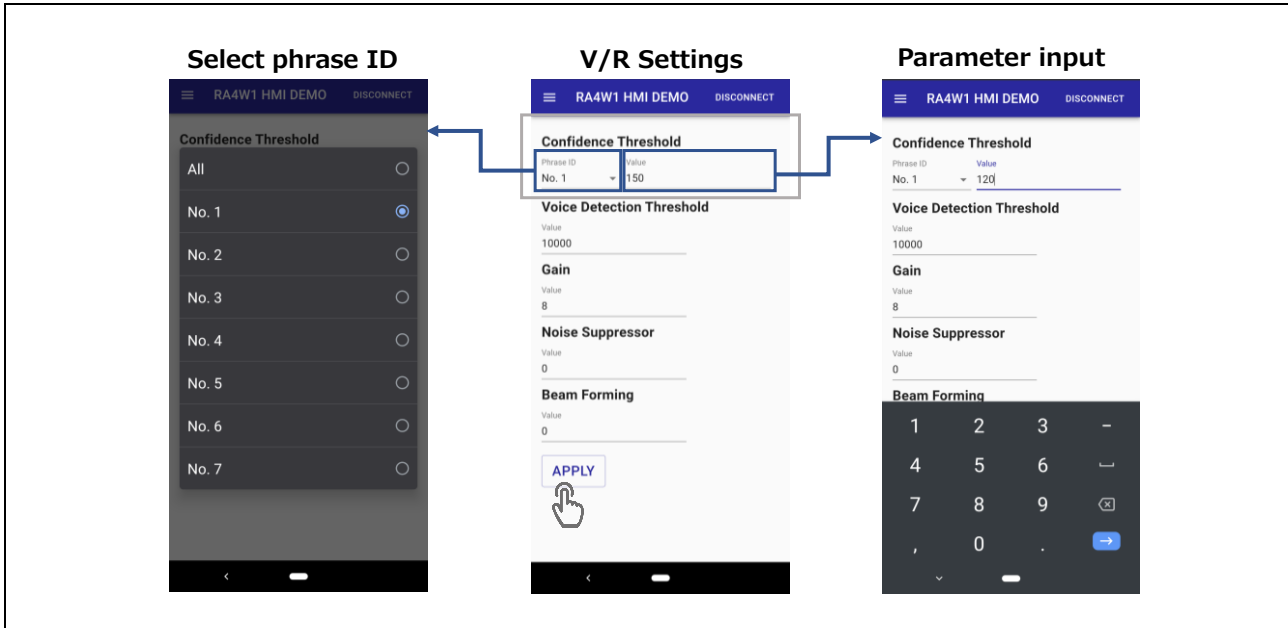

Figure 4.2 Confidence Threshold setting

- Voice Detection Threshold

Voice Detection Threshold (utterance detection) of AmiVoice can be set from 0 to 15000. Normally, set from 1000 to 15000 and lower the value easier the utterance detection. Select 'APPLY' to reflect the settings to the demo board.

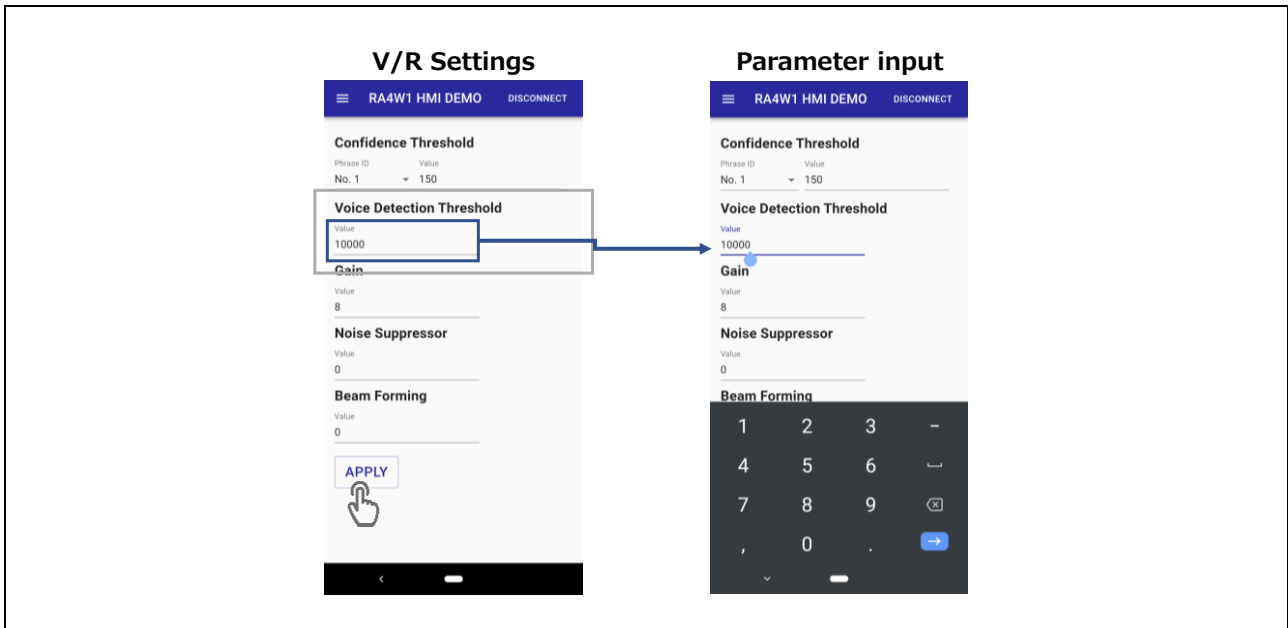

Figure 4.3 Voice Detection Threshold setting

- Gain

Set the amplification amount of the audio signal input from the microphone from 1 to 9. Select 'APPLY' to reflect the settings to the demo board.

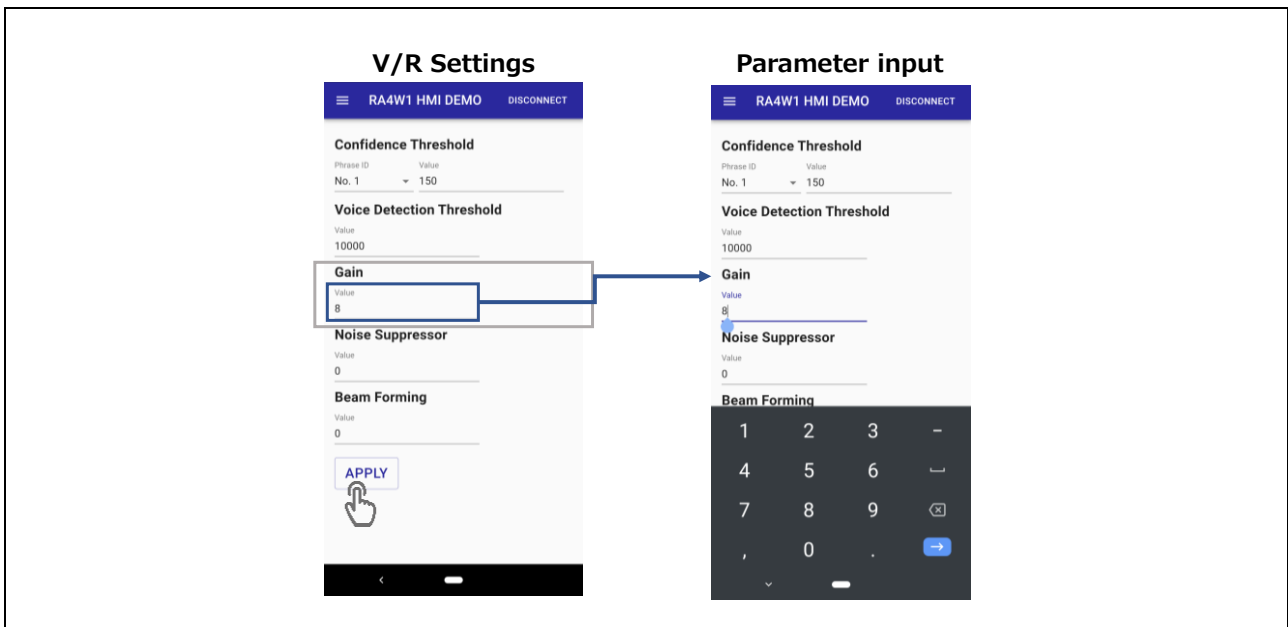

Figure 4.4 Gain setting

- Noise Suppressor

Zoom Voice Noise Suppressor value can be set from 0 to 9. Select 0 to function OFF. Larger the value, the greater the amount of noise reduction. Select 'APPLY' to reflect the settings to the demo board.

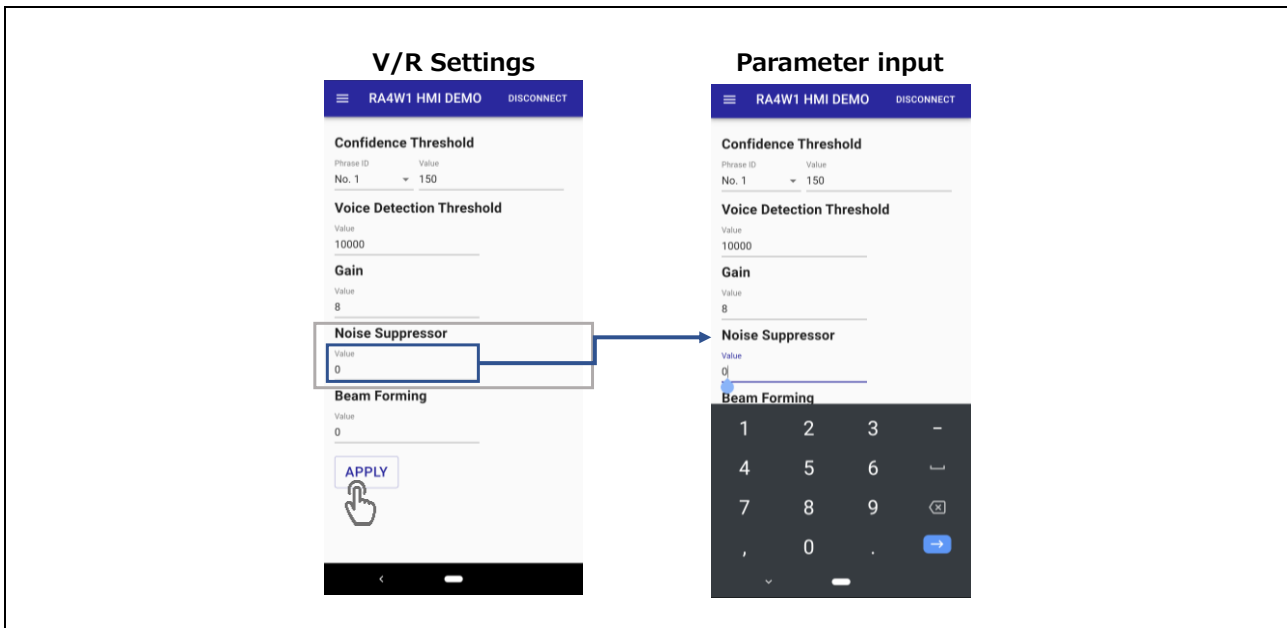

Figure 4.4 Noise Suppressor setting

- Beam Forming

Zoom Voice Beam Forming value can be set from 0 to 9. Select 0 to function OFF. The larger the value, the narrower the beamforming sound collection angle. Select 'APPLY' to reflect the settings to the demo board.

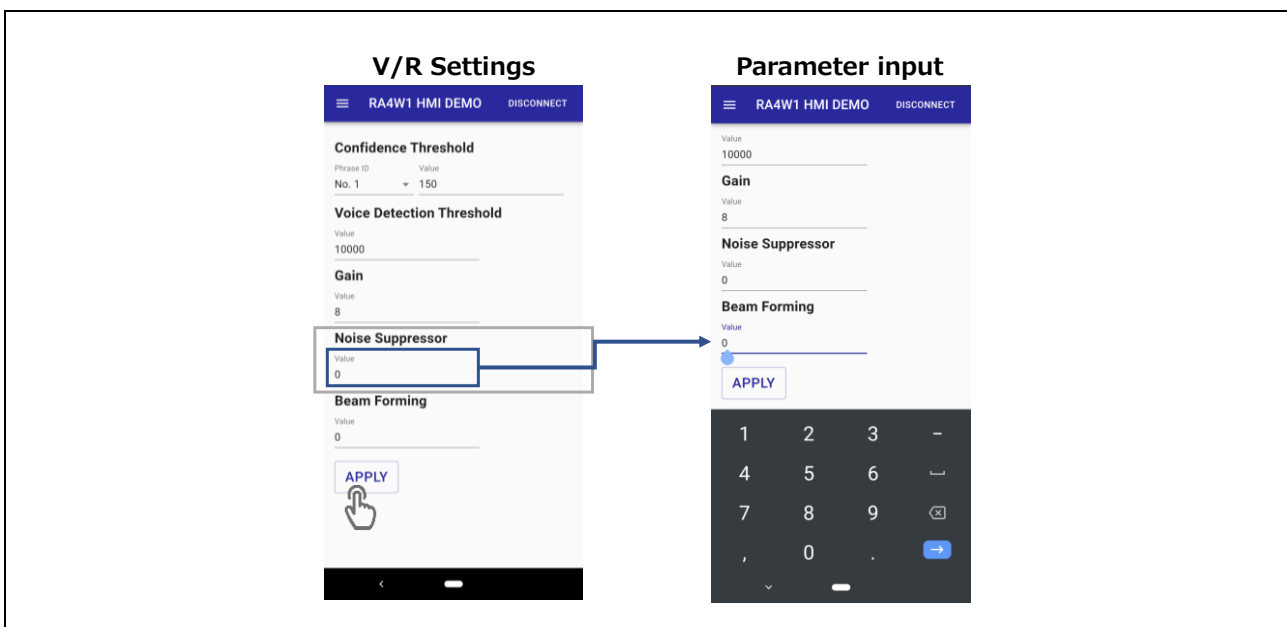

Figure 4.4 Beam Forming setting

Revision History

Rev.	Date	Description	
		Page	Summary
1.00	Jul.09.21	-	First release

General Precautions in the Handling of Microprocessing Unit and Microcontroller Unit Products

The following usage notes are applicable to all Microprocessing unit and Microcontroller unit products from Renesas. For detailed usage notes on the products covered by this document, refer to the relevant sections of the document as well as any technical updates that have been issued for the products.

1. Precaution against Electrostatic Discharge (ESD)

A strong electrical field, when exposed to a CMOS device, can cause destruction of the gate oxide and ultimately degrade the device operation. Steps must be taken to stop the generation of static electricity as much as possible, and quickly dissipate it when it occurs. Environmental control must be adequate. When it is dry, a humidifier should be used. This is recommended to avoid using insulators that can easily build up static electricity.

Semiconductor devices must be stored and transported in an anti-static container, static shielding bag or conductive material. All test and measurement tools including work benches and floors must be grounded. The operator must also be grounded using a wrist strap. Semiconductor devices must not be touched with bare hands. Similar precautions must be taken for printed circuit boards with mounted semiconductor devices.

2. Processing at power-on

The state of the product is undefined at the time when power is supplied. The states of internal circuits in the LSI are indeterminate and the states of register settings and pins are undefined at the time when power is supplied. In a finished product where the reset signal is applied to the external reset pin, the states of pins are not guaranteed from the time when power is supplied until the reset process is completed. In a similar way, the states of pins in a product that is reset by an on-chip power-on reset function are not guaranteed from the time when power is supplied until the power reaches the level at which resetting is specified.

3. Input of signal during power-off state

Do not input signals or an I/O pull-up power supply while the device is powered off. The current injection that results from input of such a signal or I/O pull-up power supply may cause malfunction and the abnormal current that passes in the device at this time may cause degradation of internal elements. Follow the guideline for input signal during power-off state as described in your product documentation.

4. Handling of unused pins

Handle unused pins in accordance with the directions given under handling of unused pins in the manual. The input pins of CMOS products are generally in the high-impedance state. In operation with an unused pin in the open-circuit state, extra electromagnetic noise is induced in the vicinity of the LSI, an associated shoot-through current flows internally, and malfunctions occur due to the false recognition of the pin state as an input signal become possible.

5. Clock signals

After applying a reset, only release the reset line after the operating clock signal becomes stable. When switching the clock signal during program execution, wait until the target clock signal is stabilized. When the clock signal is generated with an external resonator or from an external oscillator during a reset, ensure that the reset line is only released after full stabilization of the clock signal. Additionally, when switching to a clock signal produced with an external resonator or by an external oscillator while program execution is in progress, wait until the target clock signal is stable.

6. Voltage application waveform at input pin

Waveform distortion due to input noise or a reflected wave may cause malfunction. If the input of the CMOS device stays in the area between V_{IL} (Max.) and V_{IH} (Min.) due to noise, for example, the device may malfunction. Take care to prevent chattering noise from entering the device when the input level is fixed, and also in the transition period when the input level passes through the area between V_{IL} (Max.) and V_{IH} (Min.).

7. Prohibition of access to reserved addresses

Access to reserved addresses is prohibited. The reserved addresses are provided for possible future expansion of functions. Do not access these addresses as the correct operation of the LSI is not guaranteed.

8. Differences between products

Before changing from one product to another, for example to a product with a different part number, confirm that the change will not lead to problems. The characteristics of a microprocessing unit or microcontroller unit products in the same group but having a different part number might differ in terms of internal memory capacity, layout pattern, and other factors, which can affect the ranges of electrical characteristics, such as characteristic values, operating margins, immunity to noise, and amount of radiated noise. When changing to a product with a different part number, implement a system-evaluation test for the given product.

Notice

1. Descriptions of circuits, software and other related information in this document are provided only to illustrate the operation of semiconductor products and application examples. You are fully responsible for the incorporation or any other use of the circuits, software, and information in the design of your product or system. Renesas Electronics disclaims any and all liability for any losses and damages incurred by you or third parties arising from the use of these circuits, software, or information.
 2. Renesas Electronics hereby expressly disclaims any warranties against and liability for infringement or any other claims involving patents, copyrights, or other intellectual property rights of third parties, by or arising from the use of Renesas Electronics products or technical information described in this document, including but not limited to, the product data, drawings, charts, programs, algorithms, and application examples.
 3. No license, express, implied or otherwise, is granted hereby under any patents, copyrights or other intellectual property rights of Renesas Electronics or others.
 4. You shall be responsible for determining what licenses are required from any third parties, and obtaining such licenses for the lawful import, export, manufacture, sales, utilization, distribution or other disposal of any products incorporating Renesas Electronics products, if required.
 5. You shall not alter, modify, copy, or reverse engineer any Renesas Electronics product, whether in whole or in part. Renesas Electronics disclaims any and all liability for any losses or damages incurred by you or third parties arising from such alteration, modification, copying or reverse engineering.
 6. Renesas Electronics products are classified according to the following two quality grades: "Standard" and "High Quality". The intended applications for each Renesas Electronics product depends on the product's quality grade, as indicated below.
 - "Standard": Computers; office equipment; communications equipment; test and measurement equipment; audio and visual equipment; home electronic appliances; machine tools; personal electronic equipment; industrial robots; etc.
 - "High Quality": Transportation equipment (automobiles, trains, ships, etc.); traffic control (traffic lights); large-scale communication equipment; key financial terminal systems; safety control equipment; etc.
- Unless expressly designated as a high reliability product or a product for harsh environments in a Renesas Electronics data sheet or other Renesas Electronics document, Renesas Electronics products are not intended or authorized for use in products or systems that may pose a direct threat to human life or bodily injury (artificial life support devices or systems; surgical implantations; etc.), or may cause serious property damage (space system; undersea repeaters; nuclear power control systems; aircraft control systems; key plant systems; military equipment; etc.). Renesas Electronics disclaims any and all liability for any damages or losses incurred by you or any third parties arising from the use of any Renesas Electronics product that is inconsistent with any Renesas Electronics data sheet, user's manual or other Renesas Electronics document.
7. No semiconductor product is absolutely secure. Notwithstanding any security measures or features that may be implemented in Renesas Electronics hardware or software products, Renesas Electronics shall have absolutely no liability arising out of any vulnerability or security breach, including but not limited to any unauthorized access to or use of a Renesas Electronics product or a system that uses a Renesas Electronics product. RENESAS ELECTRONICS DOES NOT WARRANT OR GUARANTEE THAT RENESAS ELECTRONICS PRODUCTS, OR ANY SYSTEMS CREATED USING RENESAS ELECTRONICS PRODUCTS WILL BE INVULNERABLE OR FREE FROM CORRUPTION, ATTACK, VIRUSES, INTERFERENCE, HACKING, DATA LOSS OR THEFT, OR OTHER SECURITY INTRUSION ("Vulnerability Issues"). RENESAS ELECTRONICS DISCLAIMS ANY AND ALL RESPONSIBILITY OR LIABILITY ARISING FROM OR RELATED TO ANY VULNERABILITY ISSUES. FURTHERMORE, TO THE EXTENT PERMITTED BY APPLICABLE LAW, RENESAS ELECTRONICS DISCLAIMS ANY AND ALL WARRANTIES, EXPRESS OR IMPLIED, WITH RESPECT TO THIS DOCUMENT AND ANY RELATED OR ACCOMPANYING SOFTWARE OR HARDWARE, INCLUDING BUT NOT LIMITED TO THE IMPLIED WARRANTIES OF MERCHANTABILITY, OR FITNESS FOR A PARTICULAR PURPOSE.
 8. When using Renesas Electronics products, refer to the latest product information (data sheets, user's manuals, application notes, "General Notes for Handling and Using Semiconductor Devices" in the reliability handbook, etc.), and ensure that usage conditions are within the ranges specified by Renesas Electronics with respect to maximum ratings, operating power supply voltage range, heat dissipation characteristics, installation, etc. Renesas Electronics disclaims any and all liability for any malfunctions, failure or accident arising out of the use of Renesas Electronics products outside of such specified ranges.
 9. Although Renesas Electronics endeavors to improve the quality and reliability of Renesas Electronics products, semiconductor products have specific characteristics, such as the occurrence of failure at a certain rate and malfunctions under certain use conditions. Unless designated as a high reliability product or a product for harsh environments in a Renesas Electronics data sheet or other Renesas Electronics document, Renesas Electronics products are not subject to radiation resistance design. You are responsible for implementing safety measures to guard against the possibility of bodily injury, injury or damage caused by fire, and/or danger to the public in the event of a failure or malfunction of Renesas Electronics products, such as safety design for hardware and software, including but not limited to redundancy, fire control and malfunction prevention, appropriate treatment for aging degradation or any other appropriate measures. Because the evaluation of microcomputer software alone is very difficult and impractical, you are responsible for evaluating the safety of the final products or systems manufactured by you.
 10. Please contact a Renesas Electronics sales office for details as to environmental matters such as the environmental compatibility of each Renesas Electronics product. You are responsible for carefully and sufficiently investigating applicable laws and regulations that regulate the inclusion or use of controlled substances, including without limitation, the EU RoHS Directive, and using Renesas Electronics products in compliance with all these applicable laws and regulations. Renesas Electronics disclaims any and all liability for damages or losses occurring as a result of your noncompliance with applicable laws and regulations.
 11. Renesas Electronics products and technologies shall not be used for or incorporated into any products or systems whose manufacture, use, or sale is prohibited under any applicable domestic or foreign laws or regulations. You shall comply with any applicable export control laws and regulations promulgated and administered by the governments of any countries asserting jurisdiction over the parties or transactions.
 12. It is the responsibility of the buyer or distributor of Renesas Electronics products, or any other party who distributes, disposes of, or otherwise sells or transfers the product to a third party, to notify such third party in advance of the contents and conditions set forth in this document.
 13. This document shall not be reprinted, reproduced or duplicated in any form, in whole or in part, without prior written consent of Renesas Electronics.
 14. Please contact a Renesas Electronics sales office if you have any questions regarding the information contained in this document or Renesas Electronics products.

(Note1) "Renesas Electronics" as used in this document means Renesas Electronics Corporation and also includes its directly or indirectly controlled subsidiaries.

(Note2) "Renesas Electronics product(s)" means any product developed or manufactured by or for Renesas Electronics.

(Rev.5.0-1 October 2020)

Corporate Headquarters

TOYOSU FORESIA, 3-2-24 Toyosu,
Koto-ku, Tokyo 135-0061, Japan
www.renesas.com

Trademarks

Renesas and the Renesas logo are trademarks of Renesas Electronics Corporation. All trademarks and registered trademarks are the property of their respective owners.

Contact information

For further information on a product, technology, the most up-to-date version of a document, or your nearest sales office, please visit:
www.renesas.com/contact/.